



DENTAL INSTRUMENTS



CONTENTS

01



EXTRACTING FORCEPS

Page#01-14A.B.C

02



ROOT ELEVATORS

Page#15-15A-29

03



**DIAGNOSTIC, PROBES, SCALERS,
FILLING & LABORATORY INSTRUMENTS**

Page#30-77

04



**MAXILLOFACIAL SURGERY
INSTRUMENTS**

Page#78-95

05



**ORTHODONTIC INSTRUMENTS
& PLIERS**

Page#96-107

06



DENTAL IMPLANT INSTRUMENTS

Page#108-142

07

IMPRESSION TRAY & HOLLOW WARES

Page#143-143

EXTRACTING FORCEPS

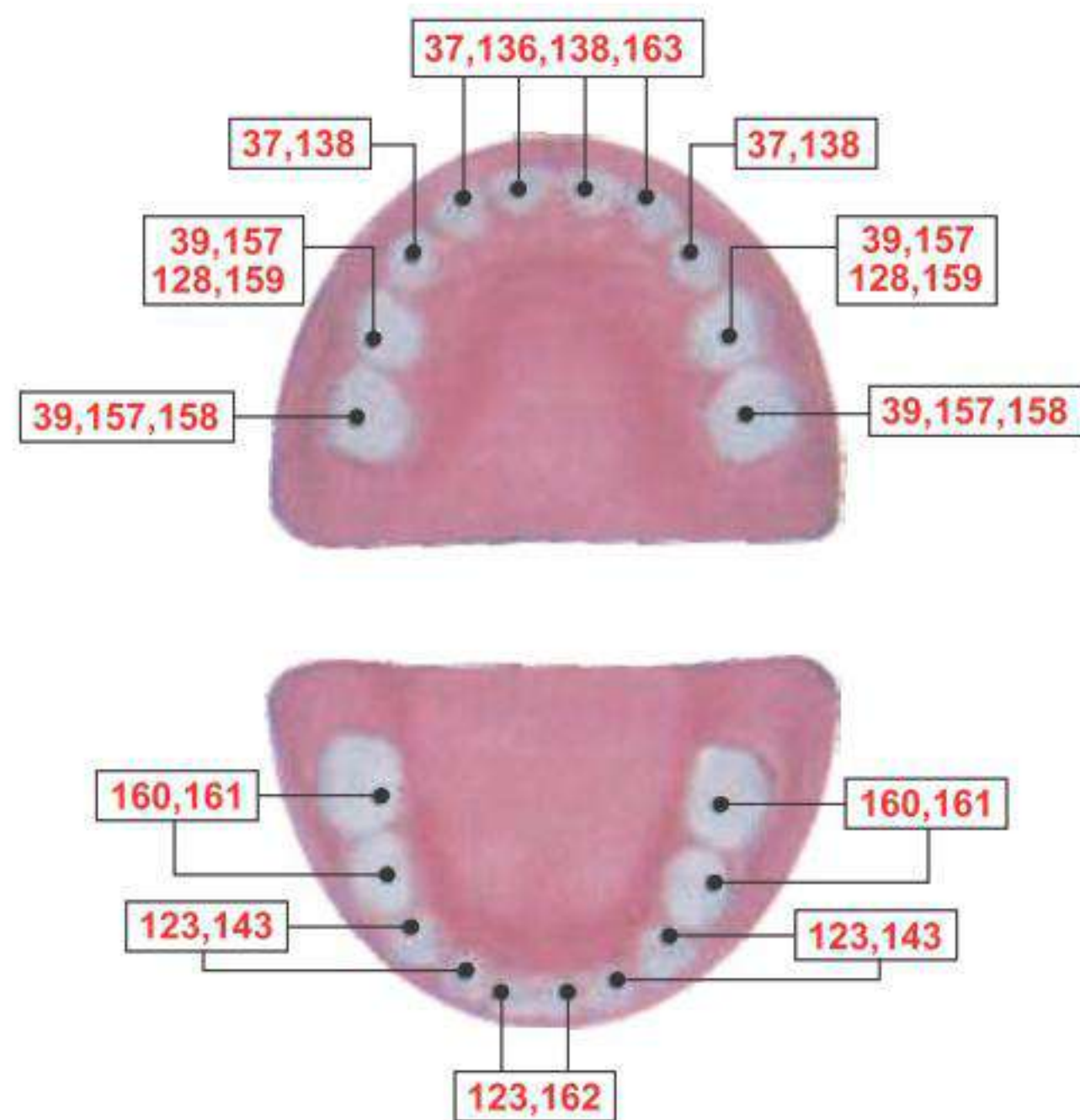
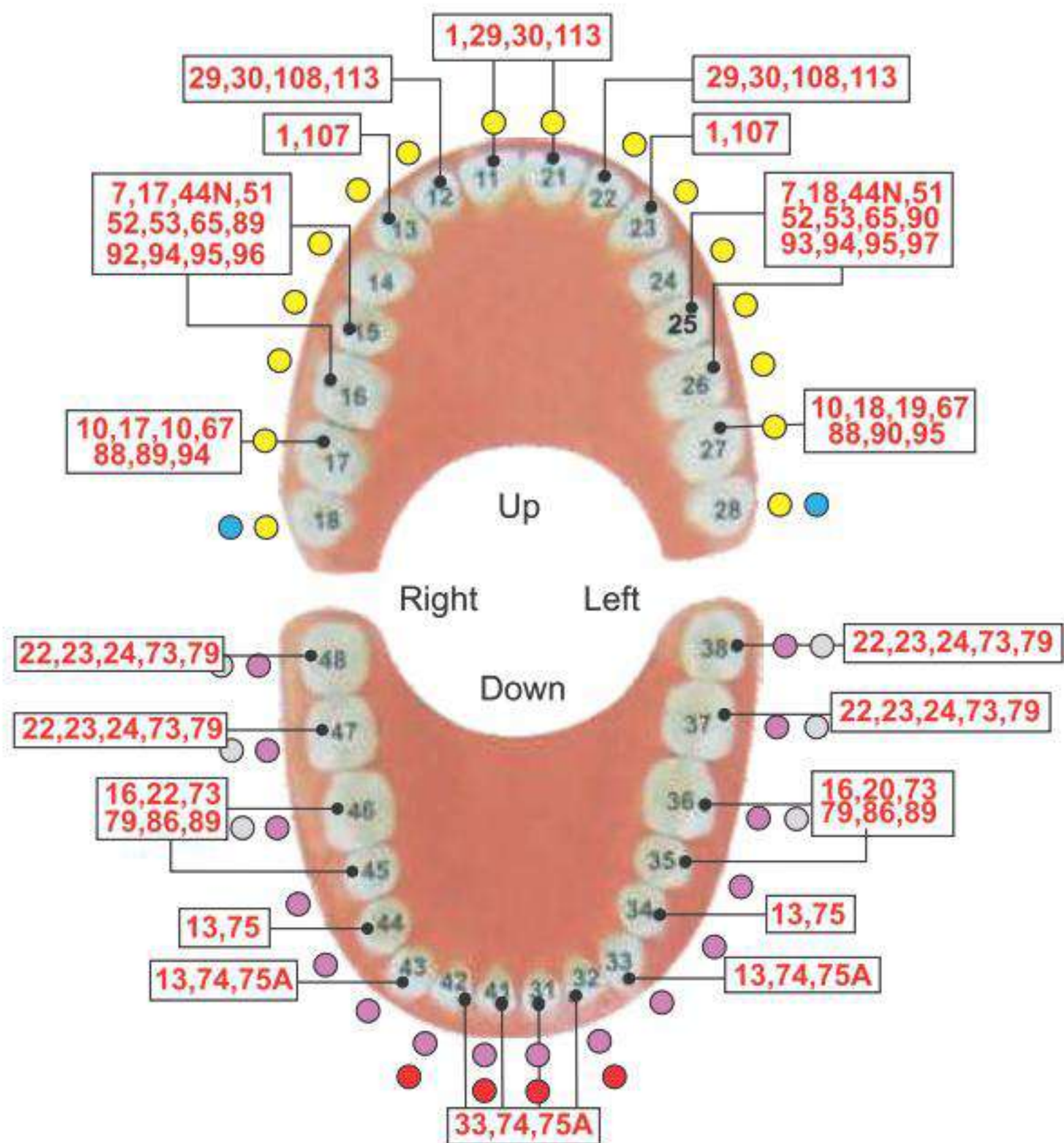

English Pattern



English Pattern
Anatomic Handle



American Pattern

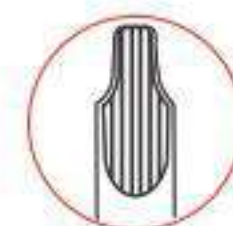

Deep Grip Forceps



EXTRACTING FORCEPS (English Pattern)

- Шипцы экстракционные (английская форма)
- Deviers (Forme Anglaise)
- Zahnzangen (Englische Form)
- Шипці екстракційні (англійська форма)
- Forceps de Extraccion (Forme Inglesa)
- استخراج ملقط (الانجليزية نمط)



786-001
Fig. 1
Upper Centrals
and Canines



786-002
Fig. 2
Upper Laterals
and Canines



786-003
Fig. 4
Lower Incisors
and Canines



786-004
Fig. 7
Upper Premolars



786-005
Fig. 8
Lower Premolars



786-006
Fig. 13
Lower Premolars



786-007
Fig. 17
Upper Molars,
Right



786-008
Fig. 18
Upper Molars,
Left



786-009
Fig. 21
Lower Molar



786-010
Fig. 22
Lower Molar

EXTRACTING FORCEPS (English Pattern)

- Шипцы экстракционные (английская форма)
- Deviers (Forme Anglaise)
- Zahnzangen (Englische Form)
- Шипці екстракційні (англійська форма)
- Forceps de Extraccion (Forme Inglesa)
- استخراج ملقط (الانجليزية نمط)

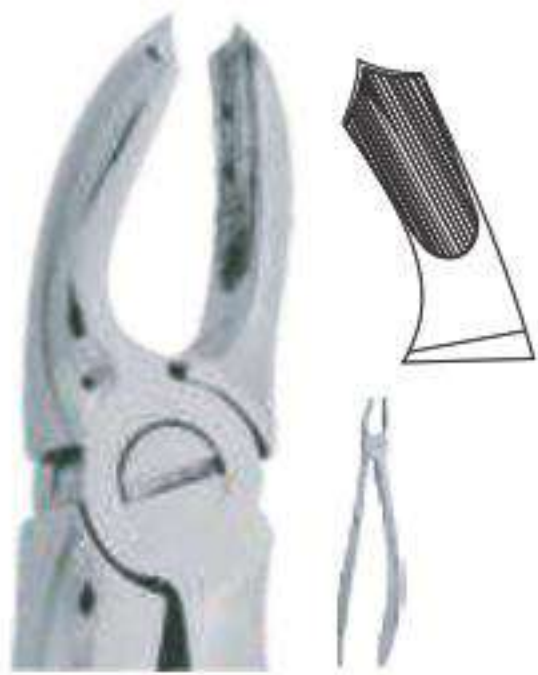

786-011
Fig. 18A
Upper Molars

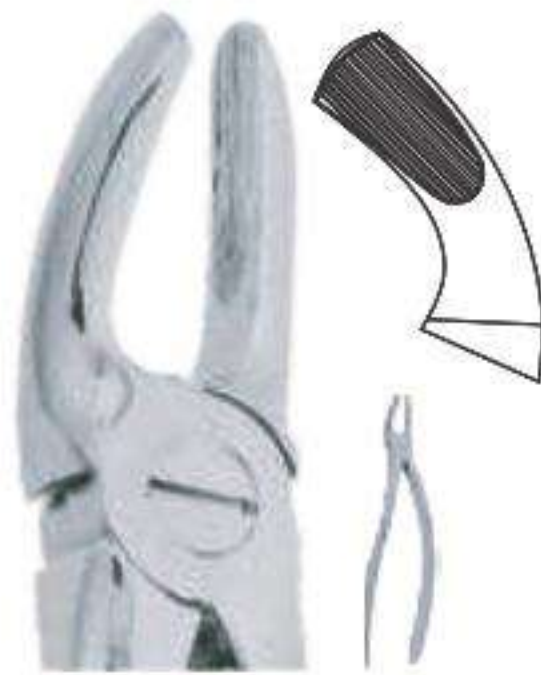

786-012
Fig. 19
Upper third Molars



786-013
Fig. 20
Lower third Molars



786-014
Fig. 24
Lower Molars
Right



786-015
Fig. 29
Upper Roots



786-016
Fig. 30
Upper Roots



786-017
Fig. 33
Lower Roots



786-018
Fig. 33A
Upper Roots



786-019
Fig. 33M
Upper Roots
with long beak



786-020
Fig. 46L
Upper Roots



786-021
Fig. 51
Upper Roots



786-022
Fig. 51A
Upper Roots

EXTRACTING FORCEPS (English Pattern)

- Щипцы экстракционные (английская форма)
- Deviers (Forme Anglaise)
- Zahnzangen (Englische Form)
- Шипці екстракційні (англійська форма)
- Forceps de Extraccion (Forme Inglesa)
- استخراج ملقط (الانجليزية نمط)

WISDOM EXTRACTING FORCEPS



786-023
Routurier
(Fig. 22 ½ L)
Lower molars and
wisdom, Left

786-024
Routurier
(Fig. 22 ½ R)
Lower molars and
wisdom, Right



786-025
Routurier
(Fig. 33 ½ L)
Lower molars and
wisdom roots, Let

786-026
Routurier
(Fig. 33 ½ R)
Lower molars and
wisdom roots, Right



786-027
Fig. 186L
Lower molars



786-028
Fig. 186R
Lower molars

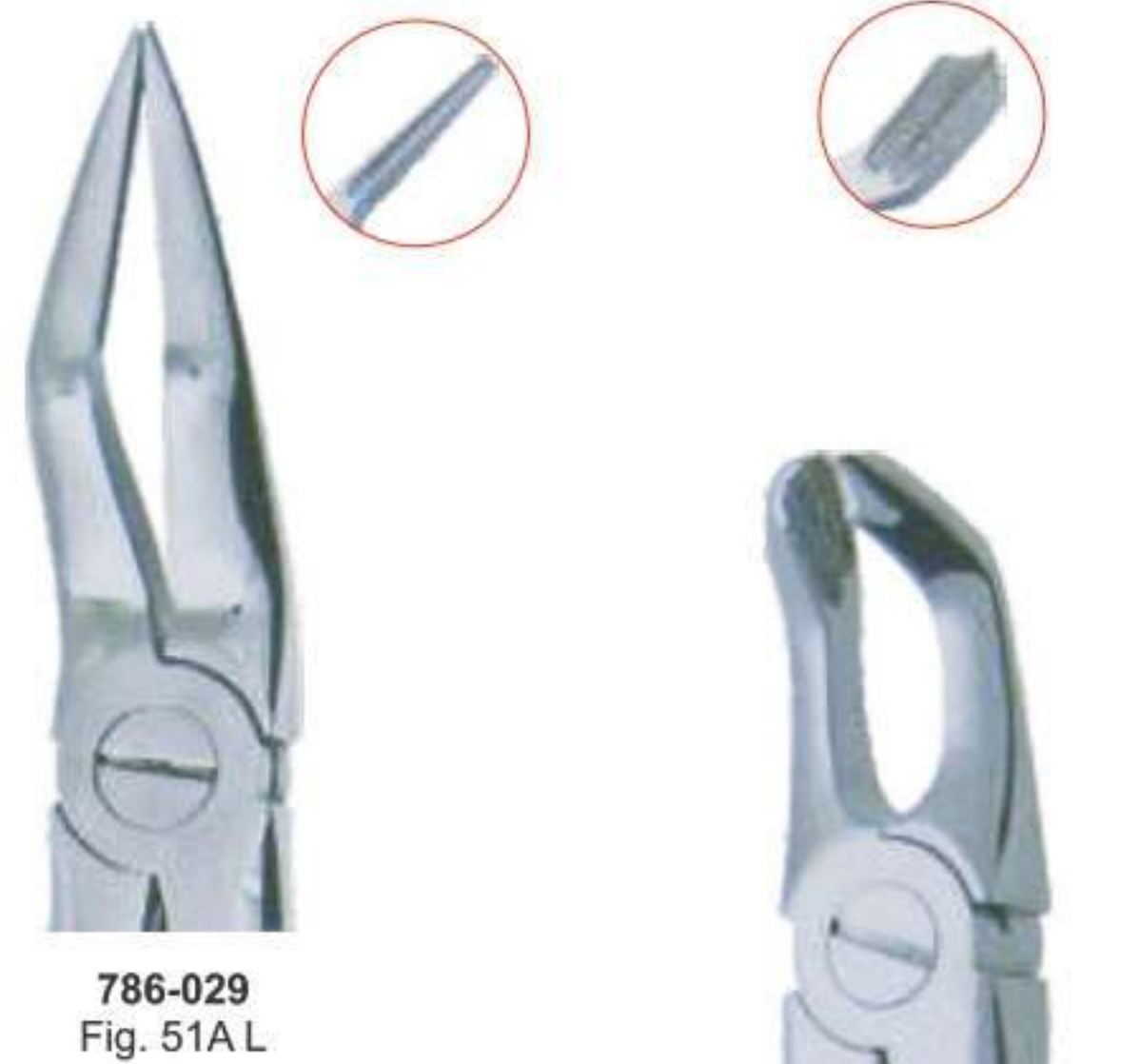

786-029
Fig. 51A L



786-030
Fig. 67
Upper third molars



786-031
Fig. 67A
Upper third molars



786-032
Fig. 79
Lower third molars

EXTRACTING FORCEPS (English Pattern)

- Щипцы экстракционные (английская форма)
- Deviers (Forme Anglaise)
- Zahnzangen (Englische Form)
- Шипці екстракційні (англійська форма)
- Forceps de Extraccion (Forme Inglesa)
- استخراج ملقط (الانجليزية نمط)



786-034
Fig. 73 A
Lower molars



786-035
Fig. 73 S



786-036
Fig. 74
Lower roots



786-037
Fig. 74N
Lower roots



786-038
Fig. 75
Lower premolars



786-039
Fig. 86A
Lower molars



786-040
Fig. 86B
Lower molars



786-041
Fig. 86C
Lower molars



786-042
Fig. 87
Lower molars



786-043
Fig. 89
Upper molars,
Right



786-044
Fig. 90
Upper molars,
Left

EXTRACTING FORCEPS (English Pattern)

- Шипцы экстракционные (английская форма)
- Deviers (Forme Anglaise)
- Zahnzangen (Englische Form)
- Шипці екстракційні (англійська форма)
- Forceps de Extraccion (Forme Inglesa)
- استخراج ملقط (الانجليزية نمط)

A-TRAUMATIC EXTRACTION
 Improved tapered beaks for complete root contact. Cross serrations
 Deep Gripe Extracting Forceps

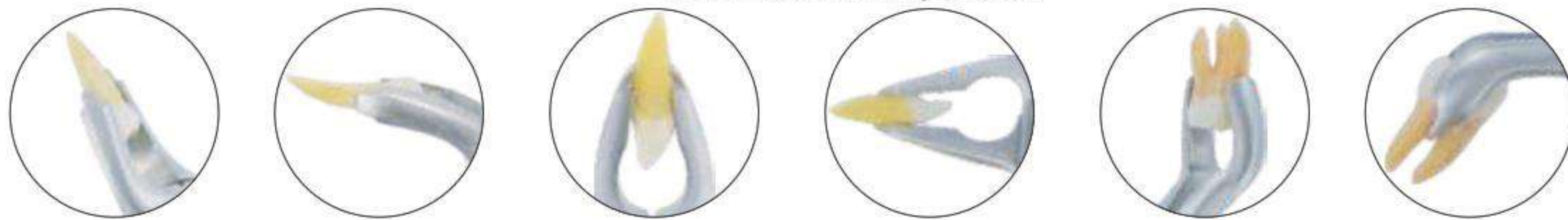

- No Fracture
- No Tissue Damage
- Extraction With Easy



786-045
 Fig. 34
 Upper incisors and
 premolars
 deep-gripping



786-046
 Fig. 34A
 Upper centrals / cains
 deep-gripping



786-047
 Fig. 35
 Upper premolars
 deep-gripping



786-048
 Fig. 35A
 Upper incisors and
 premolars
 deep-gripping



786-049
 Fig. 36
 Lower premolars
 deep-gripping



786-050
 Fig. 36A
 Lower premolars
 deep-gripping



786-051
 Fig. 336
 Lower premolars
 deep-gripping



786-052
 Fig. 7C
 Lower molar



786-053
 Fig. 9
 Apex Forceps Lower Universal
 deep root pick



786-054
 Fig. 79N
 Lower third molars
 deep-gripping



786-055
 Fig. 34
 Lower third molars
 deep gripping

EXTRACTING FORCEPS (English Pattern)

- Щипцы экстракционные (английская форма)
- Deviers (Forme Anglaise)
- Zahnzangen (Englische Form)
- Шипці екстракційні (англійська форма)
- Forceps de Extraccion (Forme Inglesa)
- استخراج ملقط (الانجليزية نمط)

DEEP GRIP FORCEPS

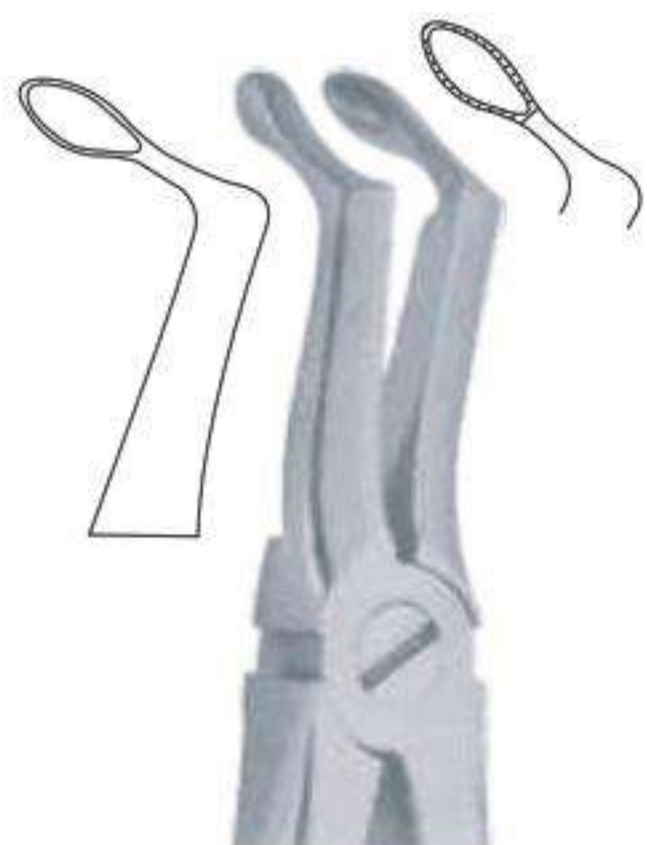

786-056
Fig. 146
Apex Forceps Lower Root
Deep Root Pick

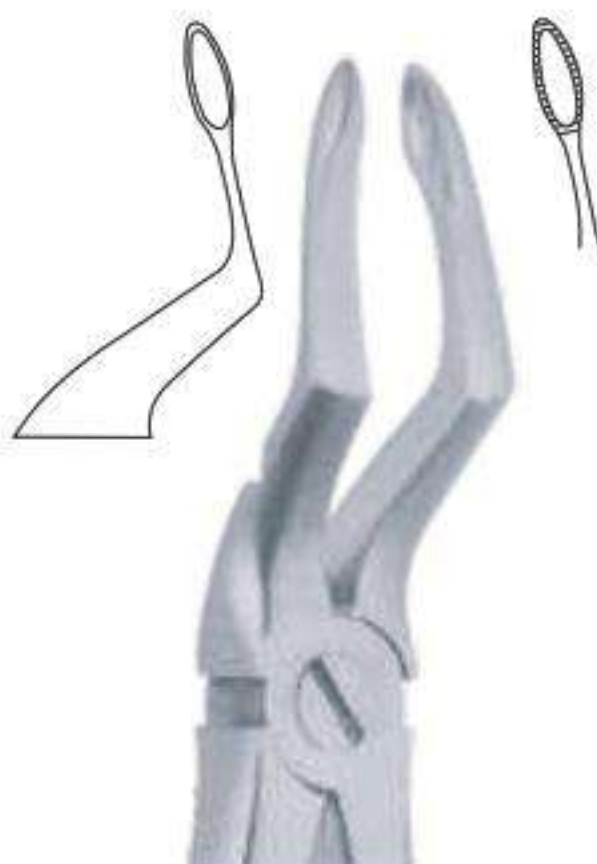

786-057
Fig. 153
Apex Forceps Upper Root
Deep Root Pick



786-058
Fig. 149
Apex Forceps Upper Root
Deep Root Pick



786-059
Fig. 44



786-060
Fig. 44Z



786-061
Fig. 45Z



786-062
Fig. 46 XL
Apex Forceps Lower Root
Deep Root Pick



786-063
Fig. 67
Upper third molars



786-064
Fig. 67A
Upper third molars



786-065
Fig. 67N
Lower third molars
deep-gripping



786-066
Fig. 331
Upper roots
deep-gripping

EXTRACTING FORCEPS (English Pattern)

- Щипцы экстракционные (английская форма)
- Deviers (Forme Anglaise)
- Zahnzangen (Englische Form)
- Шипці екстракційні (англійська форма)
- Forceps de Extraccion (Forme Inglesa)
- استخراج ملقط (الانجليزية نمط)



Fig. 1
Upper laterals
and canines



786-067 Set of 10 Pieces

- Fig. 1
- Fig. 7
- Fig. 13
- Fig. 17
- Fig. 18
- Fig. 22
- Fig. 51A
- Fig. 67
- Fig. 74N
- Fig. 79

Fig. 7
Upper premolars



Fig. 13
Lower premolars



Fig. 17
Upper molars
Right



Fig. 18
Upper molars
Left



Fig. 22
Lower roots



Fig. 51A
Upper roots



Fig. 67
Upper third
molars



Fig. 74N
Lower molars



Fig. 79
Lower third
molars



EXTRACTING FORCEPS

- Щипцы экстракционные
- Deviers
- Zahnzangen

- Щипці екстракційні
- Forceps de Extraccion
- استخراج ملقط

Pediatric Tooth Extracting Forceps Set



786-068
English Pattern Klien # 51S
Pedodontic, Upper root



786-069
English Pattern Klien # 137
Pedodontic, Upper incisors spring handle



786-072
English Pattern Klien # 5
Pedodontic Lower incisors



786-070
English Pattern Klien # 139
Pedodontic Upper Premolars



Fig. # 01 to 07
Set of 7 Pieces



786-073
English Pattern Klien # 7
Pedodontic Lower roots.



786-071
English Pattern Klien # 3
Pedodontic Upper molars
universal

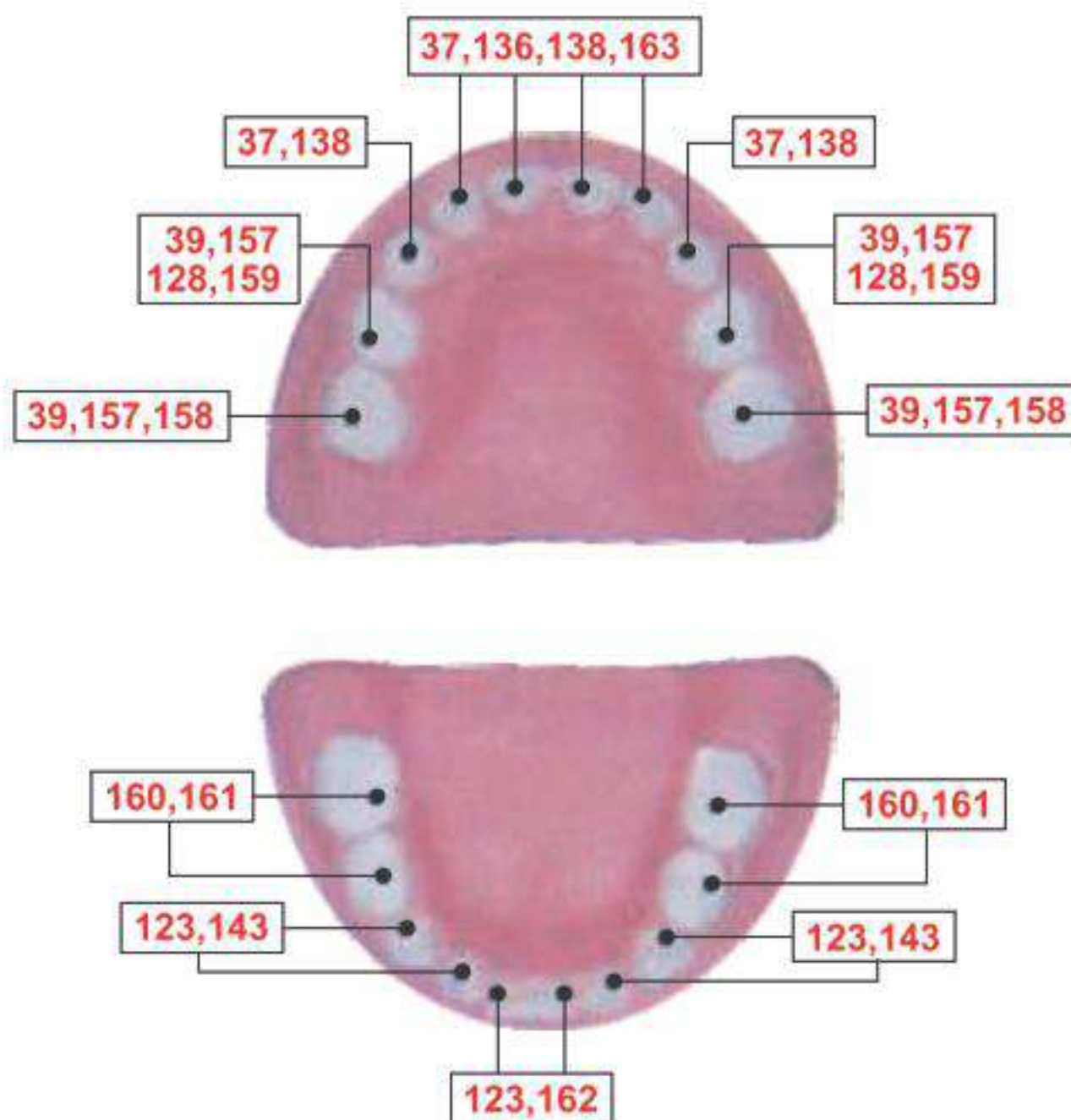

786-074
English Pattern Klien # 6
Pedodontic Lower molars,
spring handle

EXTRACTING FORCEPS (American Pattern)

- Щипцы экстракционные (американская форма)
- Deviers - forme americane
- Forceps de extracción - forma americana
- Щипці екстракційні (американська форма)
- Pinzeta per astrazione - forma americana
- استخراج ملقط (النمط الأمريكي)



786-075
Fig, 1STD
Winter
upper centrals and canines



786-076
Fig, 1
Upper incisors and roots



786-077
Fig, 150
Cryer

EXTRACTING FORCEPS (American Pattern)

- Щипцы экстракционные (американская форма)
- Deviers - forme americane
- Forceps de extracción - forma americana
- Щипці екстракційні (американська форма)
- Pinzeta per astrazione - forma americana
- استخراج ملقط (النمط الأمريكي)



786-078
Fig, 150A
Cryer
Upper incisors Premolars roots



786-079
Fig, 62
Cryer
Incisors premolars,
deciduous teeth

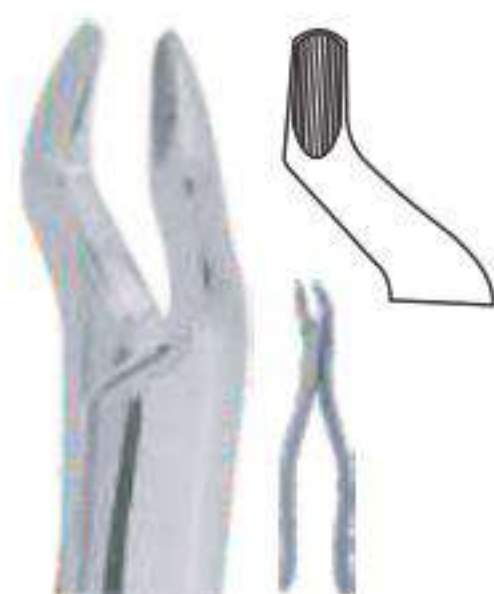

786-080
Fig, 10S
Upper roots

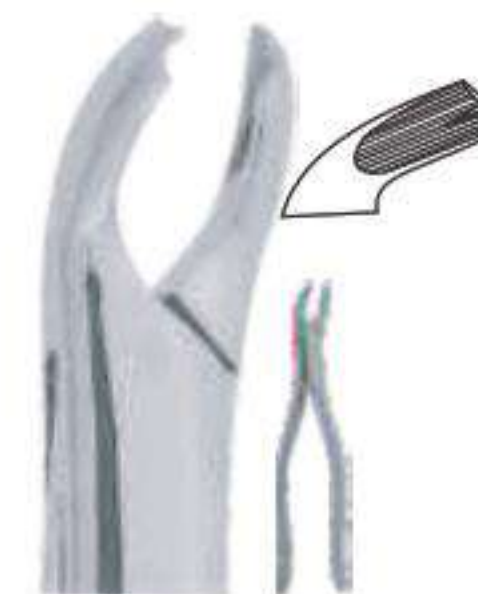

786-081
Fig, 17
Lower molars



786-082
Harris
Fig, 18R



786-083
Harris
Fig, 18L

EXTRACTING FORCEPS (American Pattern)

- Щиплы экстракционные (американская форма)
- Deviers - forme americane
- Forceps de extracción - forma americana
- Щипці екстракційні (американська форма)
- Pinzere per astrazione - forma americana
- استخراج ملقط (النمط الأمريكي)



786-084
Fig, 210
Cryer
Upper third molars



786-085
Fig, 53R
Upper molars, right



786-086
Fig, 53L
Upper molars, left



786-087
Fig, 88R
NEVIUS



EXTRACTING FORCEPS (American Pattern)

- Щипцы экстракционные (американская форма)
- Deviers (forme americane)
- Forceps de extracción - forma americana
- Щипці екстракційні (американська форма)
- Pinzeta per astrazione - forma americana
- استخراج ملقط (المنطق الأمريكي)



786-088
Fig, 24
Upper molars



786-089
Fig, 210S
Upper third molars



786-090
Fig, 210H
Upper third molars



786-091
Fig, 286
Upper roots,
Premolars, incisors



786-092
Fig, 99C
Kells
Upper incisors
canines, premolars

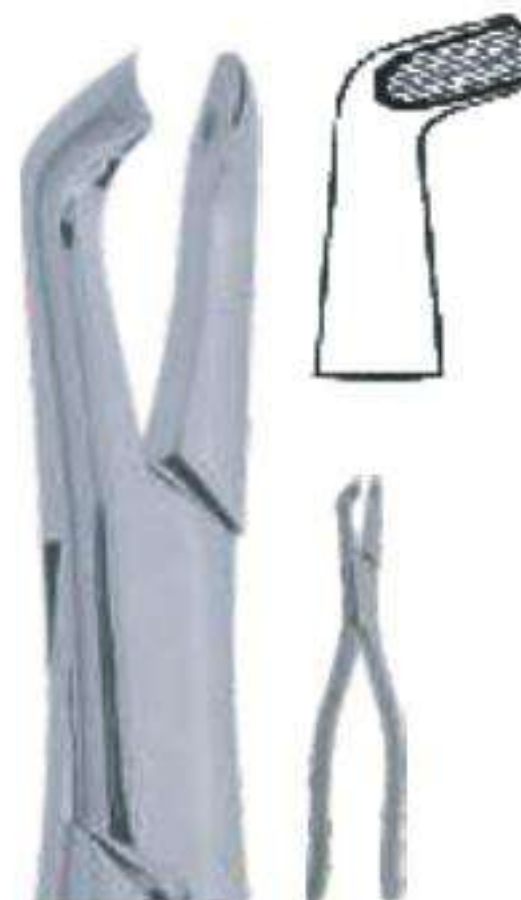

786-093
Fig, 222
Lower third molars



786-094
Fig, 286
Lower molars

EXTRACTING FORCEPS (American Pattern)

- Щипцы экстракционные (американская форма)
- Deviers - forme americane
- Forceps de extracción - forma americana
- Щипці екстракційні (американська форма)
- Pinzeta per astrazione - forma americana
- استخراج ملقط (النمط الأمريكي)



786-095
Fig, 88L
Nevius
Upper incisors, Left



786-096
Fig, 65
Upper incisors,
and roots



786-097
Fig, 32A
Parmlly
Upper premolars
and roots



786-098
Fig, 32
Parmlly
Upper premolars
and molars



EXTRACTING FORCEPS (American Pattern)

- Щипцы экстракционные (американская форма)
- Deviers - forme americane
- Forceps de extracción - forma americana
- Щипці екстракційні (американська форма)
- Pinzere per astrazione - forma americana
- استخراج ملقط (النمط الأمريكي)



786-099
COHEN
Universal

786-100
Fig. 203
Lower incisors
and roots

786-101
Fig. 69
Tomes
Upper and lower roots

EXTRACTING FORCEPS (American Pattern)

- Щипцы экстракционные (американская форма)
- Deviers - forme americane
- Forceps de extracción - forma americana

- Щипці екстракційні (американська форма)
- Pinzere per astrazione - forma americana
- استخراج ملقط (المنظ الأمريكي)



786-102
Fig, 23
Lower molars



786-103
Fig, 16
Lower molars



786-104
Fig, 5
PHYSIC
Lower third molars



786-105
Fig, 15
HARRIS
Lower molars



786-106
Fig, 103

EXTRACTING FORCEPS (American Pattern)

- Щипцы экстракционные (американская форма)
- Deviers - forme americane
- Forceps de extracción - forma americana
- Щипці екстракційні (американська форма)
- Pinzere per astrazione - forma americana
- استخراج ملقط (النمط الأمريكي)



786-109
Fig. 1
Upper Anterior

786-110
Lower Molar
Fig. 23 Cow Horn



786-111
Fig. 23
Lower Anterior



786-112
Fig. 88L
Upper Molar Left



786-113
Fig. 88R
Upper Molar Right



786-114
Fig. 74
Lower Anterior



786-115
Fig. 106
Lower Incisors



786-116
Fig. 174
Extra Narrow
Lower Anterior
Apical Retention
Forceps



786-117
Fig. 859
Lower Molar
Roots



DENTAL SYRINGES

■ Шприцы стоматологические карпульные
 ■ Seringues á usage dentaire
 ■ Dentspritzen

■ شپريڤ سٹوماتولوڤيكي كاريولني
 ■ Jeringes dentales
 ■ السندرين



786-118 1.8ML
 786-119 2.2ML



786-130
 #1001
 Intraligamental
 Anesthesia Syringe
 in Black Colout



786-120 1.8ML
 786-121 2.2ML



786-131 1.8ML
 786-132 2.2ML
 Angled



786-122 1.8ML
 786-123 2.2ML



786-133
 Alumium - Dark 1.8 ML



786-124 1.8ML
 786-125 2.2ML



786-134
 Alumium - Silver 1.8 ML



786-126 1.8ML
 786-127 2.2ML



786-135
 Alumium - Orange 1.8 ML



786-128 1.8ML
 786-129 2.2ML



786-136
 Alumium - Green 1.8 ML



786-137
 Alumium - Blue 1.8 ML

BONE RONGEURS

- Костные кусачки
- HohmeiBelangen
- Pincés-gouges

- Кусачки для кісток
- Pinzas-gubias
- روتنجيور من العظام



786-138
Blumental
15cm



786-139
Blumental
15cm



786-140
Blumental
15cm



786-141
Friedman
14cm



786-142
Friedman
14.5cm



786-143
Micro-Friedman
14cm



786-144
Micro-Friedman
15cm



786-145
Micro-Friedman
16cm



786-146
Kleinert-Kutz
18.5cm



786-147
Beyer
18.5cm



786-148
Mead 1A
18.5cm



786-149
Luer
18.5cm

ROOT ELEVATOR

- Элеватор корневой экстракционный
- Elevateurs à racines
- Wurzelheber

- Elevador cornevio extraclivnyy
- Elevadores para raices
- مصاعد الجذر

Apexo Root Elevators



Apexo

786-150
Apexo
2.5x9mm
Straight

786-151
Apexo
2.7x9mm
Straight

786-152
Apexo
3.0x9mm
Straight

786-153
Apexo
2.5x9mm
Curved

786-154
Apexo
3.0x9mm
Curved

786-155
Seldin
3.4x14mm
Straight

Luxator Root Elevators



Luxator

786-156
Luxator
3mm
Straight

786-157
Luxator
3mm
Curved

786-158
Luxator
4mm
Straight

786-159
Luxator
4mm
Curved

786-160
Luxator
5mm
Straight

786-161
Luxator
5mm
Curved

Bein Root Elevators



Bein

2mm
786-162
Bein 2mm

3mm
786-163
Bein 3mm

4mm
786-164
Bein 4mm

Seldin Root Elevators



Seldin

3.5mm
786-165
Flohr 1

4mm
786-166
Seldin 34S

5mm
786-167
Seldin 34

ROOT ELEVATOR

- Elevator корневой экстракционный
- Elevateurs à racines
- Wurzelheber

- Elevator cornevier ekstrakční
- Elevadores para raices
- مصاعد الجذر

Apexo Root Elevators



Apexo



786-168
Apexo
2.5x9mm
Straight



786-169
Apexo
2.7x9mm
Straight



786-170
Apexo
3.0x9mm
Straight



786-171
Apexo
2.5x9mm
Curved



786-172
Apexo
3.0x9mm
Curved



786-173
Seldin
3.4x14mm
Straight

Luxator Root Elevators



Luxator



786-174
Luxator
3mm
Straight



786-175
Luxator
3mm
Curved



786-176
Luxator
4mm
Straight



786-177
Luxator
4mm
Curved



786-178
Luxator
5mm
Straight



786-179
Luxator
5mm
Curved

Bein Root Elevators



Bein



786-180
Bein 2mm



786-181
Bein 3mm



786-182
Bein 4mm

Seldin Root Elevators



Seldin



786-183
Flohr 1



786-184
Seldin 34S



786-185
Seldin 34

ROOT ELEVATOR

- Элеватор корневой экстракционный
- Elevateurs à racines
- Wurzelheber

- Элеватор корневий екстракційний
- Elevadores para raices
- مصاعد الجذر

Apical Root Elevators

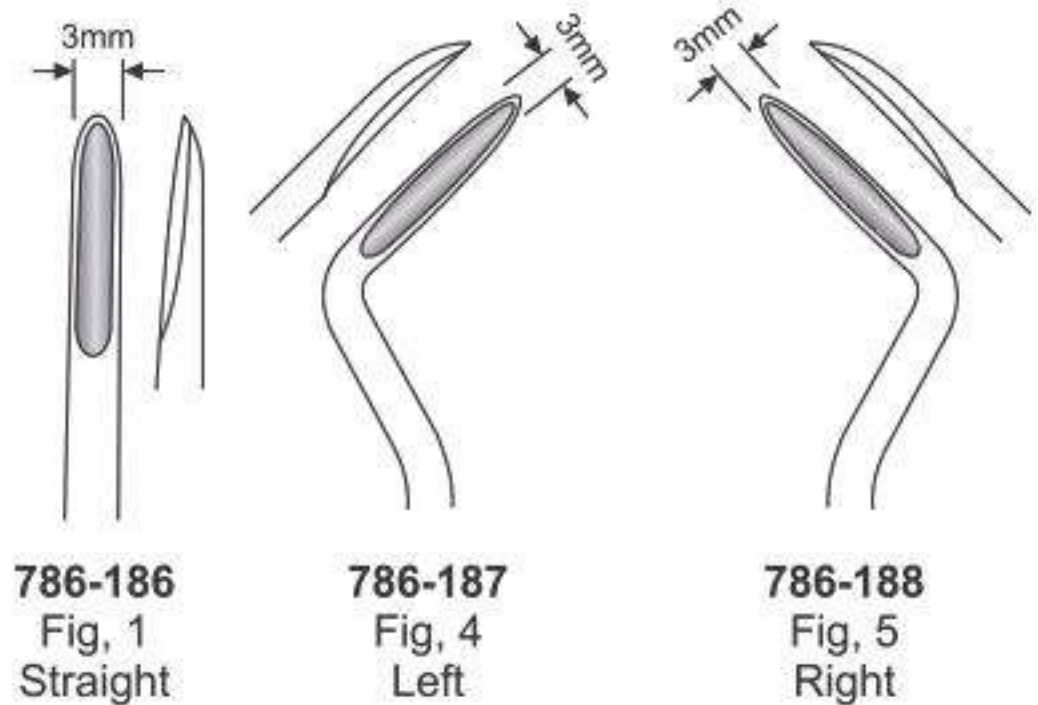

Apical Root Elevators

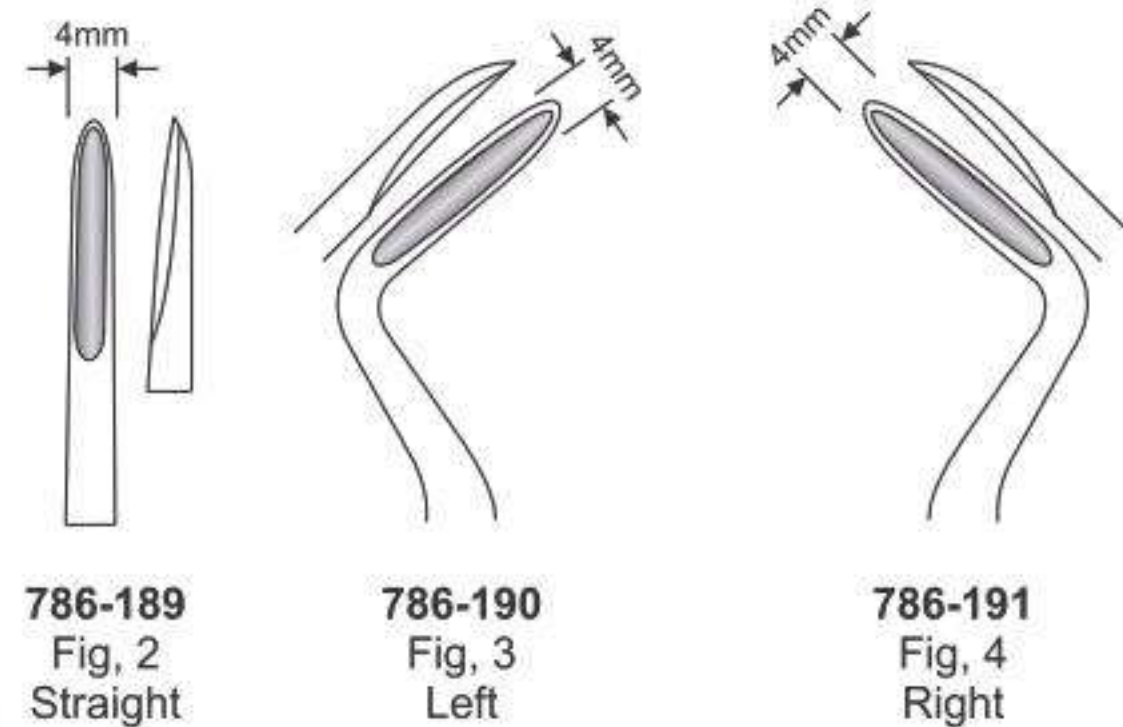

Coupland Root Elevators

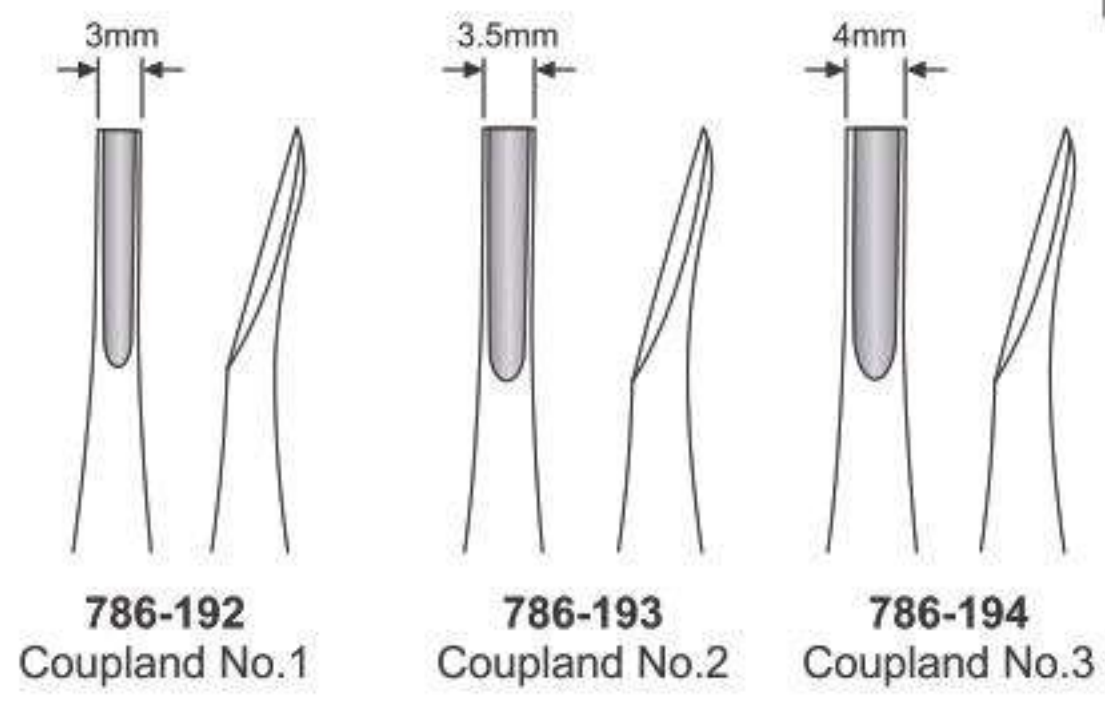

Coupland

Seldin Root Elevators

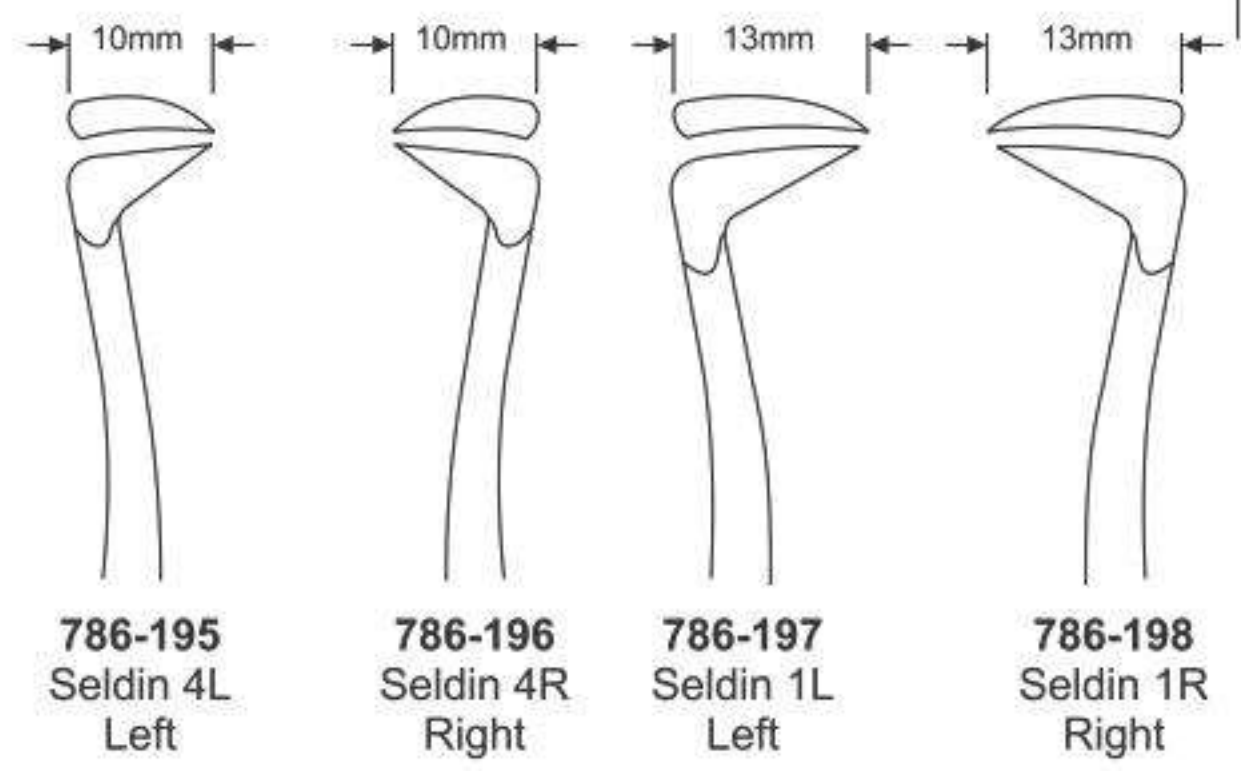

Seldin 13-3 Straight



786-199 Seldin Left



786-200 Seldin Right

ROOT ELEVATOR

- Элеватор корневой экстракционный
- Élévateurs à racines
- Wurzelheber

- Elevator coronevii ekstraktsionniy
- Elevadores para raices
- مصاعد الجذر

Apical Root Elevators

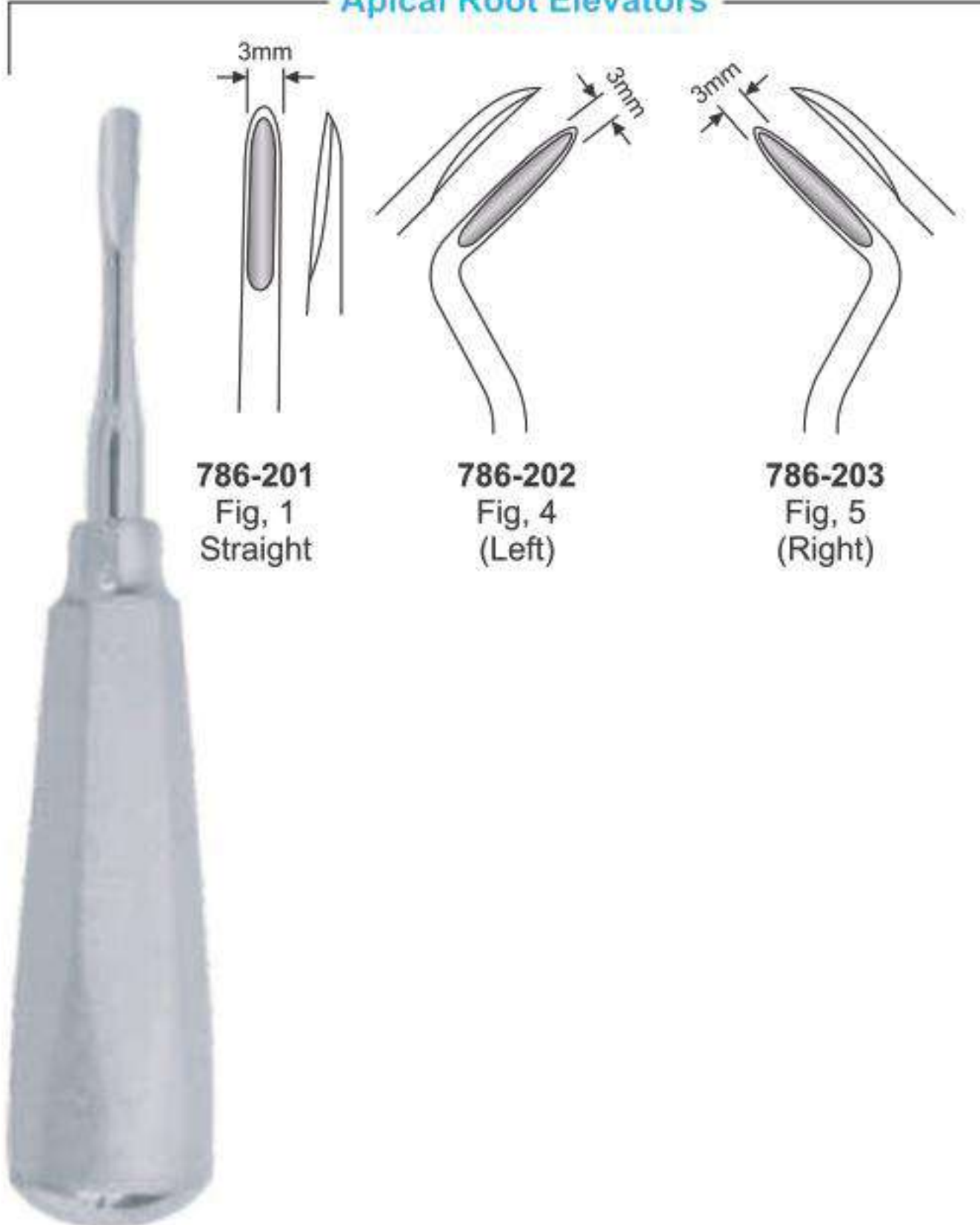

Apical Root Elevators

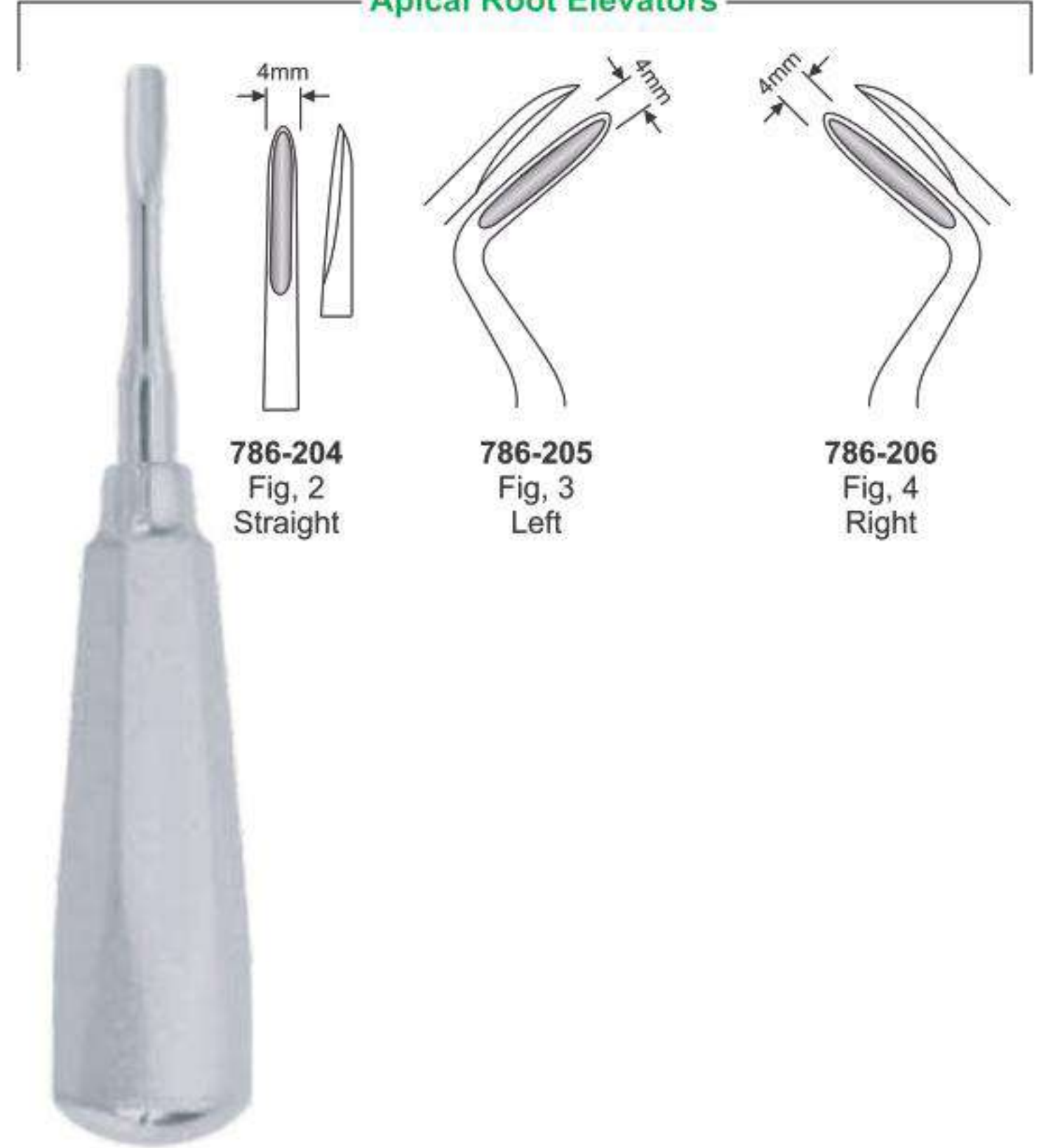

Coupland Root Elevators

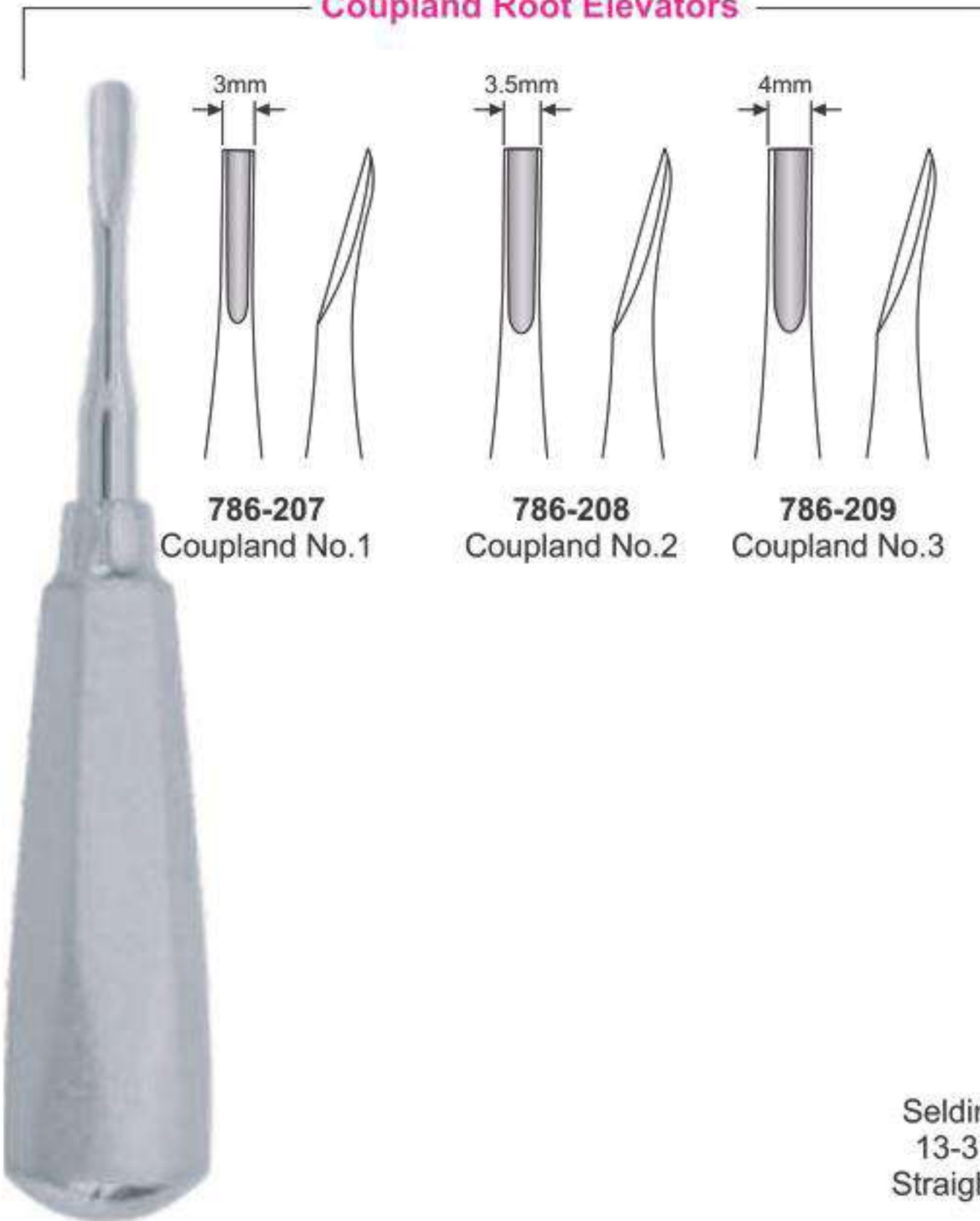

Seldin Root Elevators

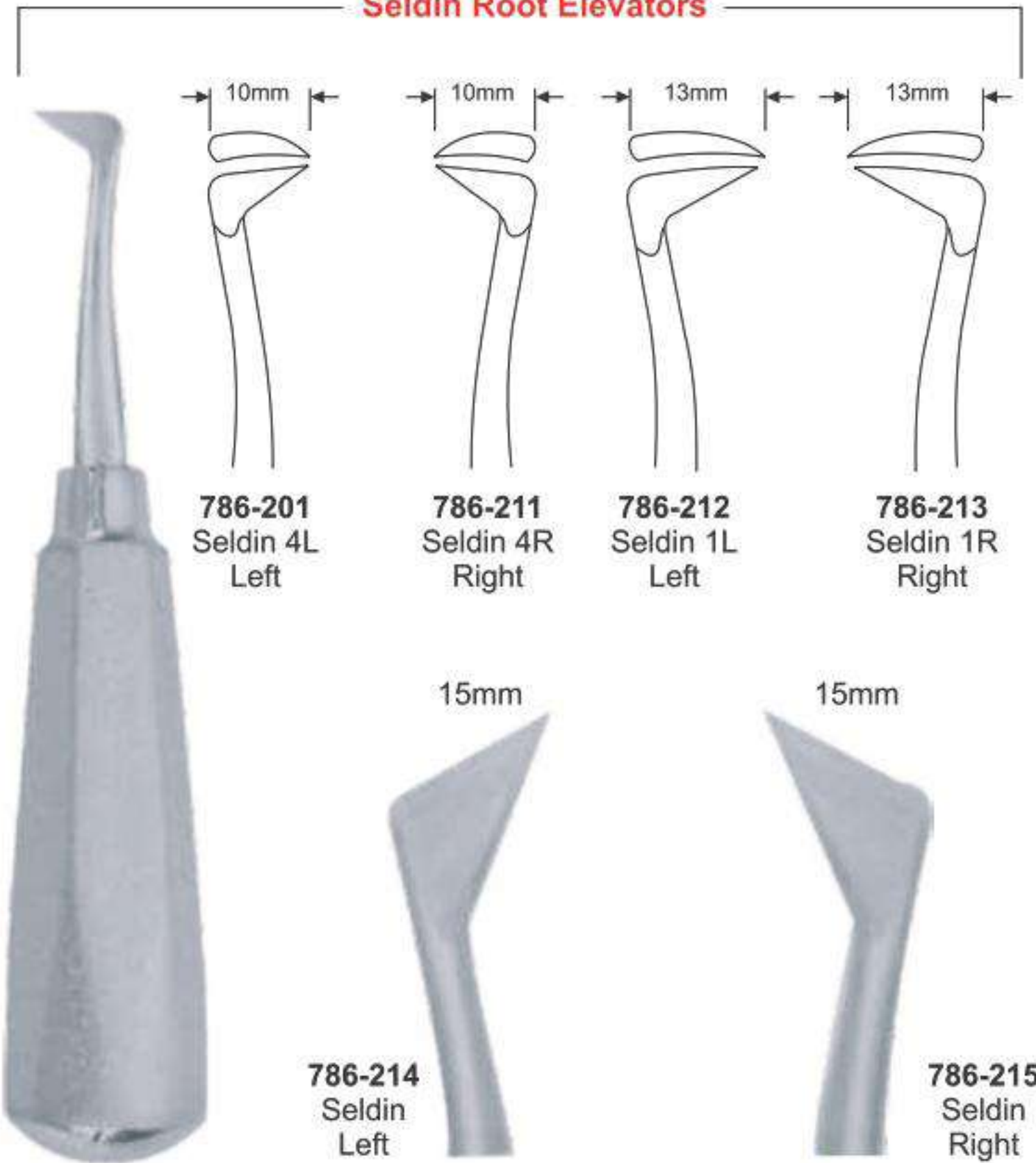

ROOT ELEVATOR

- Элеватор «корневой» экстракционный
- Elevateurs à racines
- Wurzelheber

- Elevator «корневой» экстракционный
- Elevadores para raices
- مصاعد الجذر

Apical Root Elevator

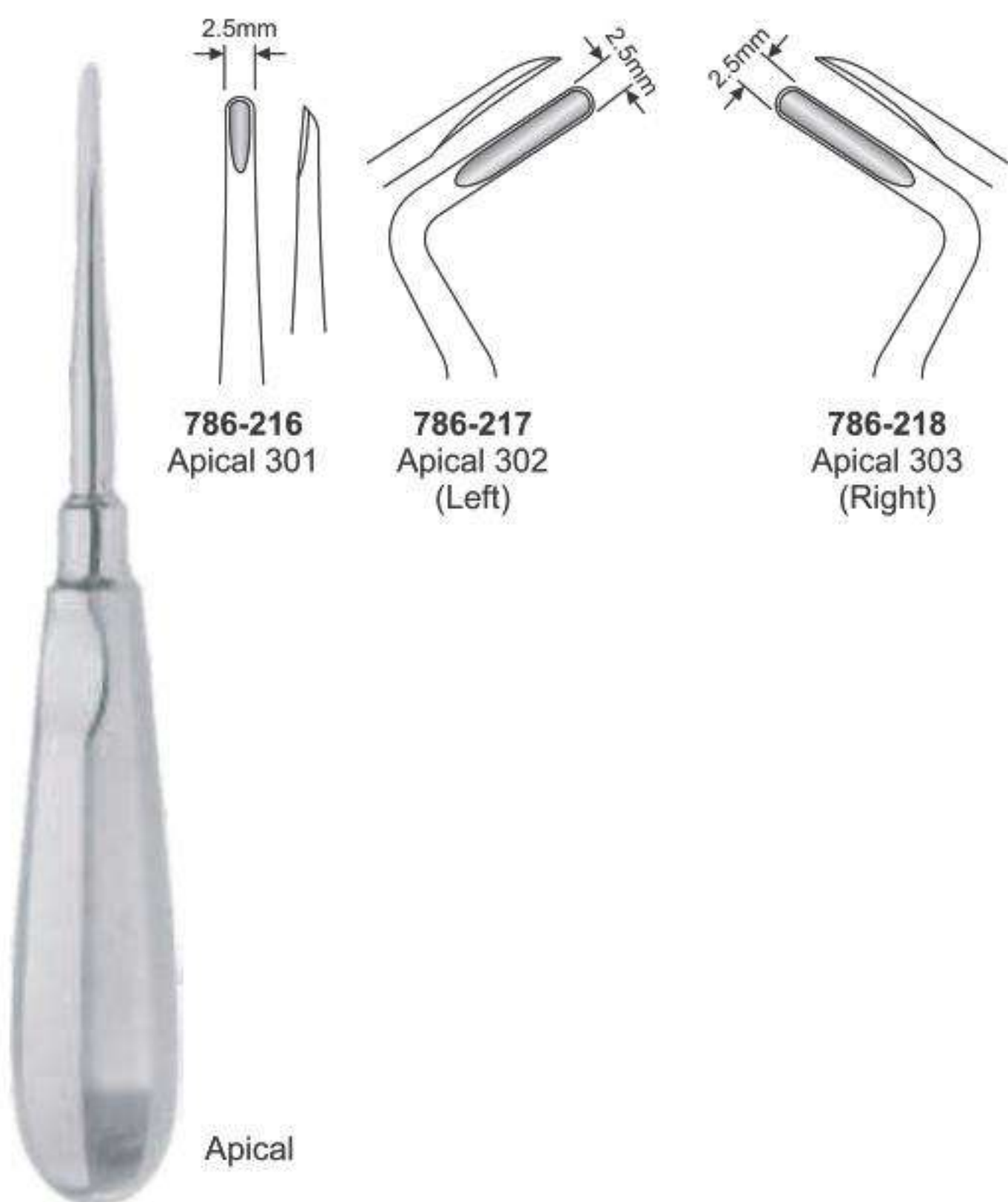

Apical Root Elevator

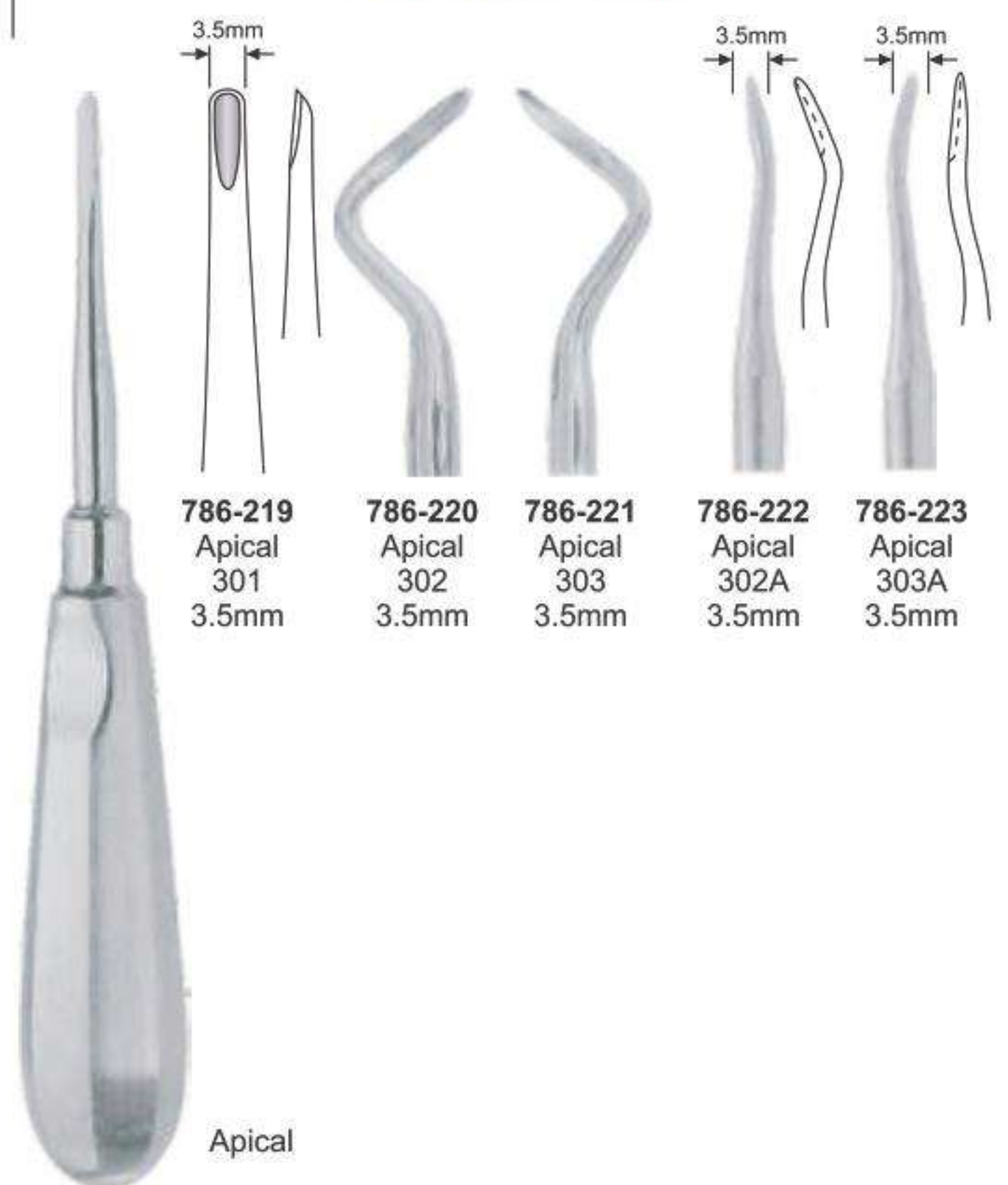

Apical Root Elevator



Laxutor Root Elevator

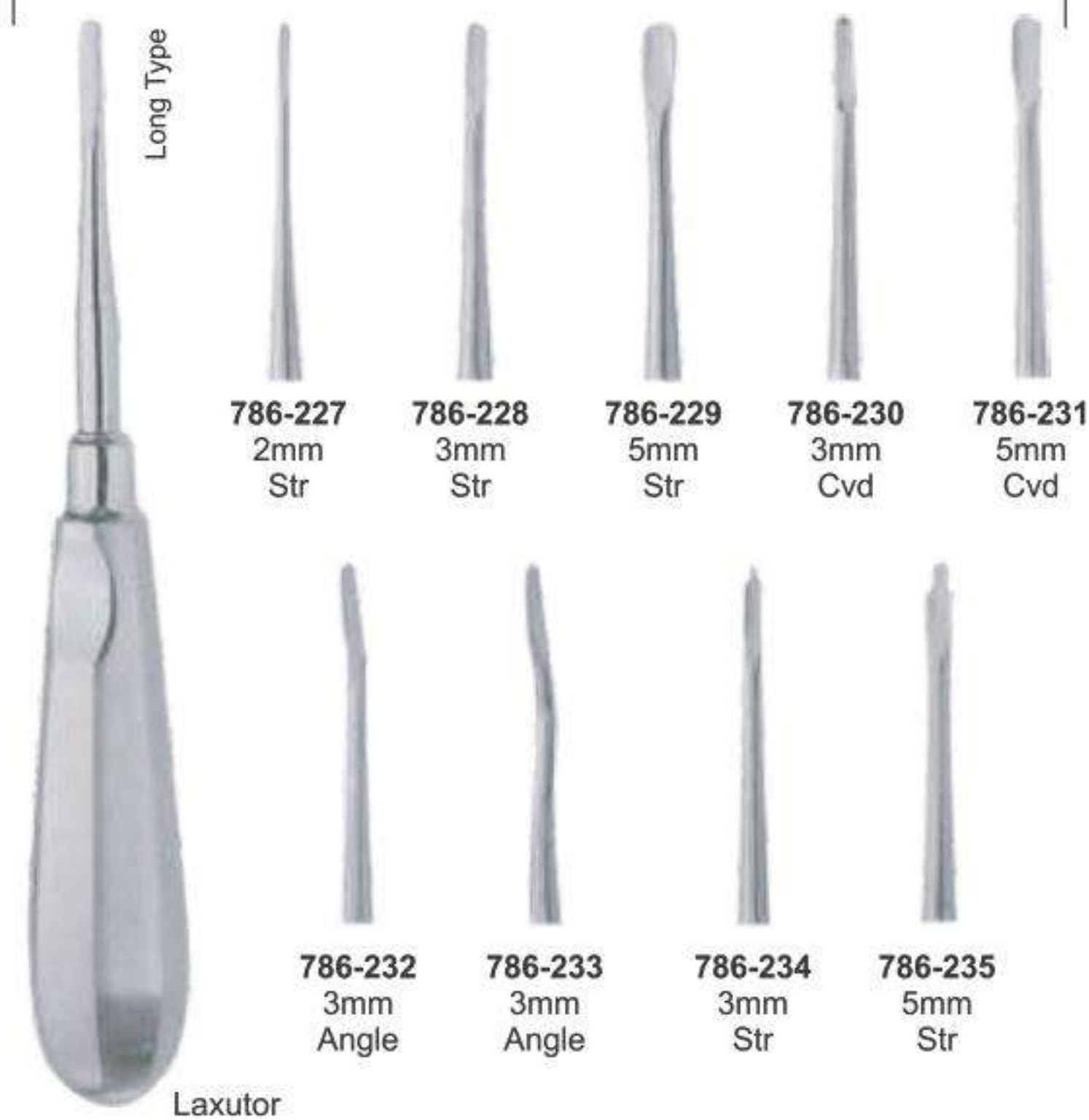

ROOT ELEVATOR

- Элеватор корневой экстракционный
- Elévateurs à racines
- Wurzelheber

- Elevador coronario extractivo
- Elevadores para raices
- مساعد الجذر

Lindo Levian Root Elevator

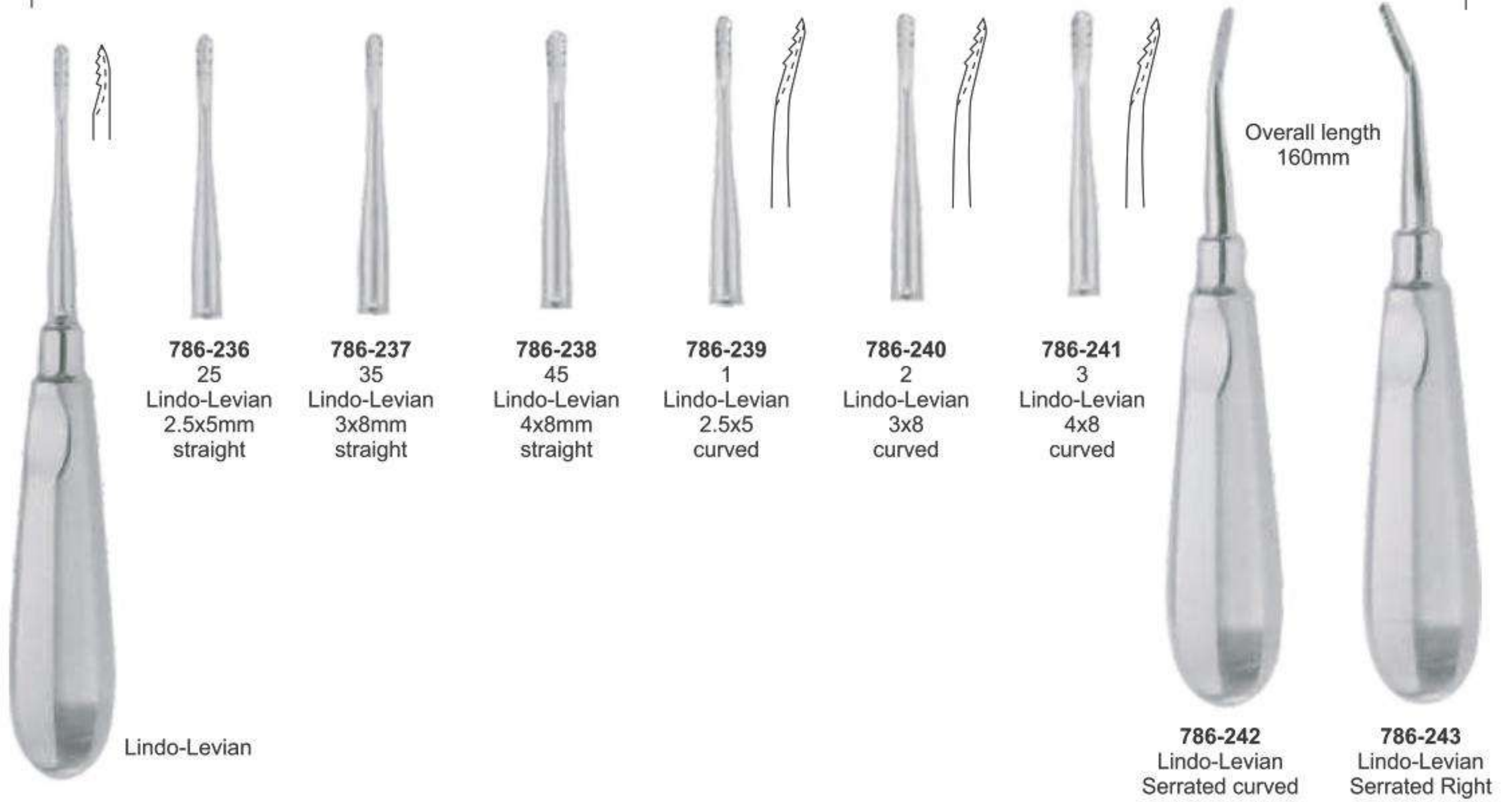

Flohr Root Elevator



Heidbrink Root Elevator

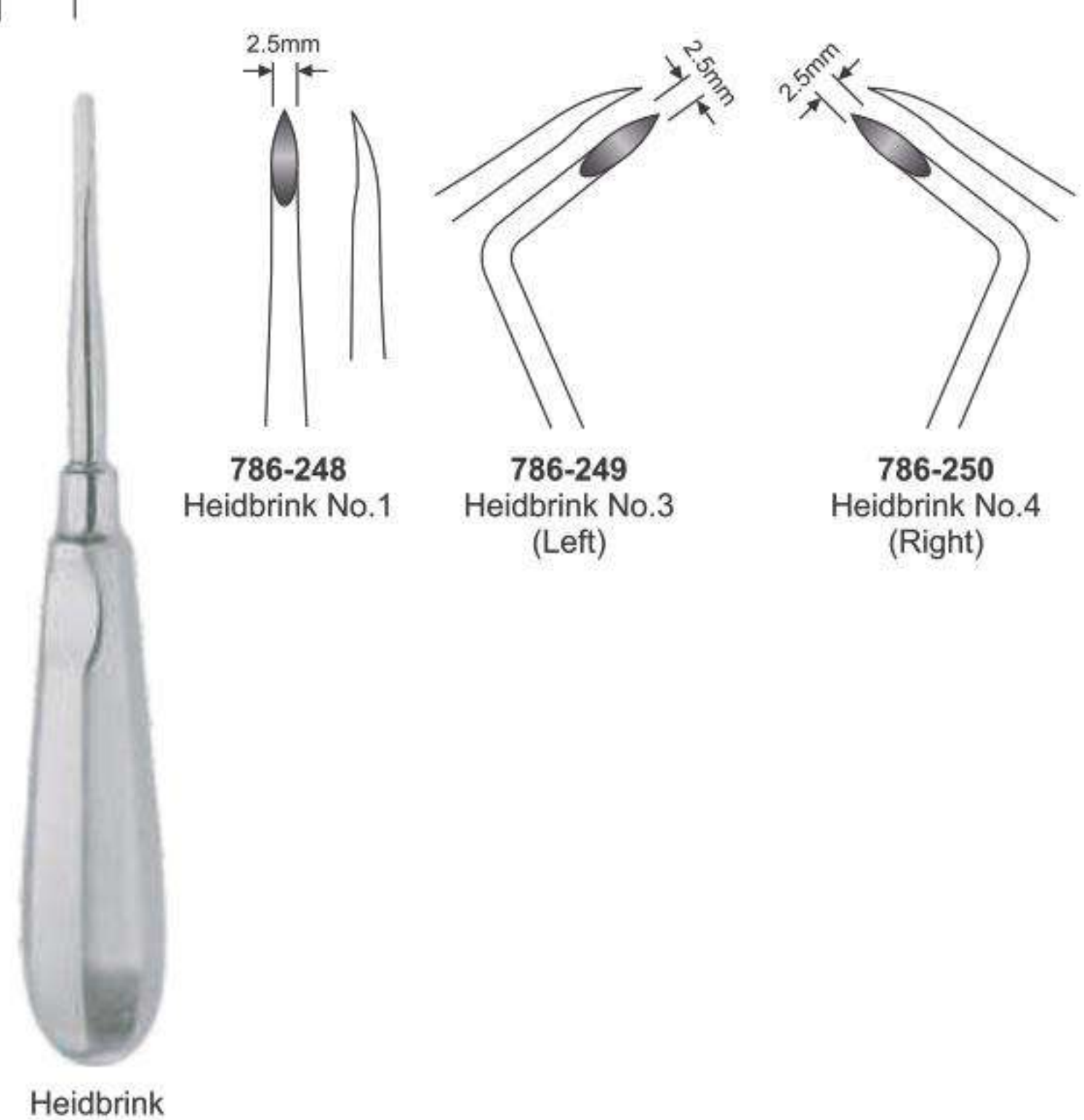

ROOT ELEVATOR

- Элеватор корневой экстракционный
- Elevateurs à racines
- Wurzelheber

- Элеватор «корневий» екстракційний
- Elevadores para raices
- مصاعد الجذر

Friedmann Roots Elevator



786-251 Friedmann 4F Str
786-252 Friedmann 5F Left
786-253 Friedmann 6F Right

Heidbrink Roots Elevator



786-254 Heidbrink Straight
786-255 Heidbrink Left
786-256 Heidbrink Right

Wisdom Roots Elevator



786-257 Wisdom for 18 and 38
786-258 Wisdom for 28 and 48

Bayonet Roots Elevator (Set)



786-259 Left
786-260 Right
786-261 Bayonet
786-262 Curved
786-263 Straight

Luxator Roots Elevator



786-264 Luxator Straight
786-265 Luxator Curved

ROOT ELEVATOR

- Elevator корневой экстракционный
- Elévateurs à racines
- Wurzelheber

- Elevator корневой экстракционный
- Elevadores para raices
- مصاعد الجذر

Roots Elevator

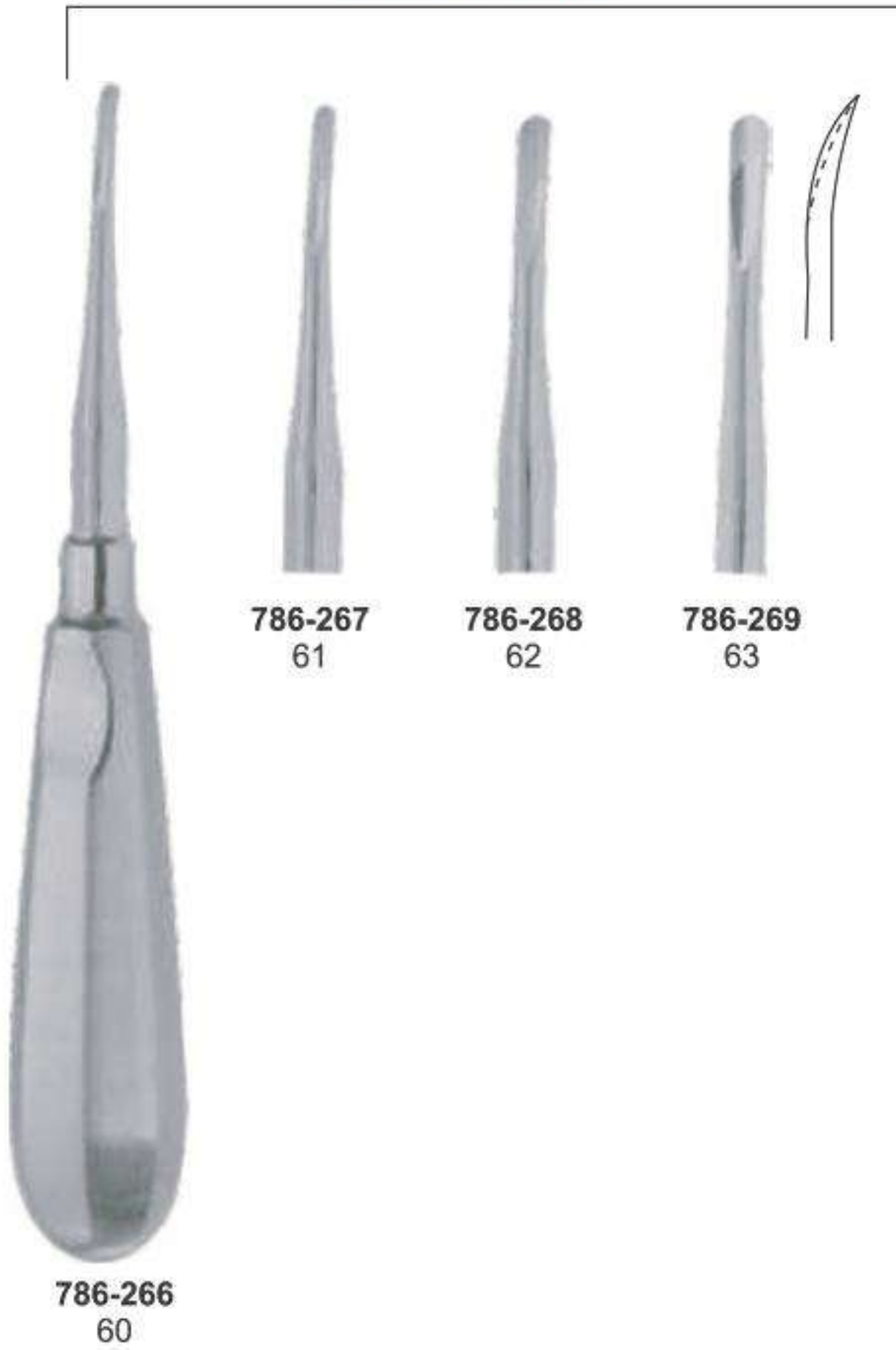

Luxier Roots Elevator

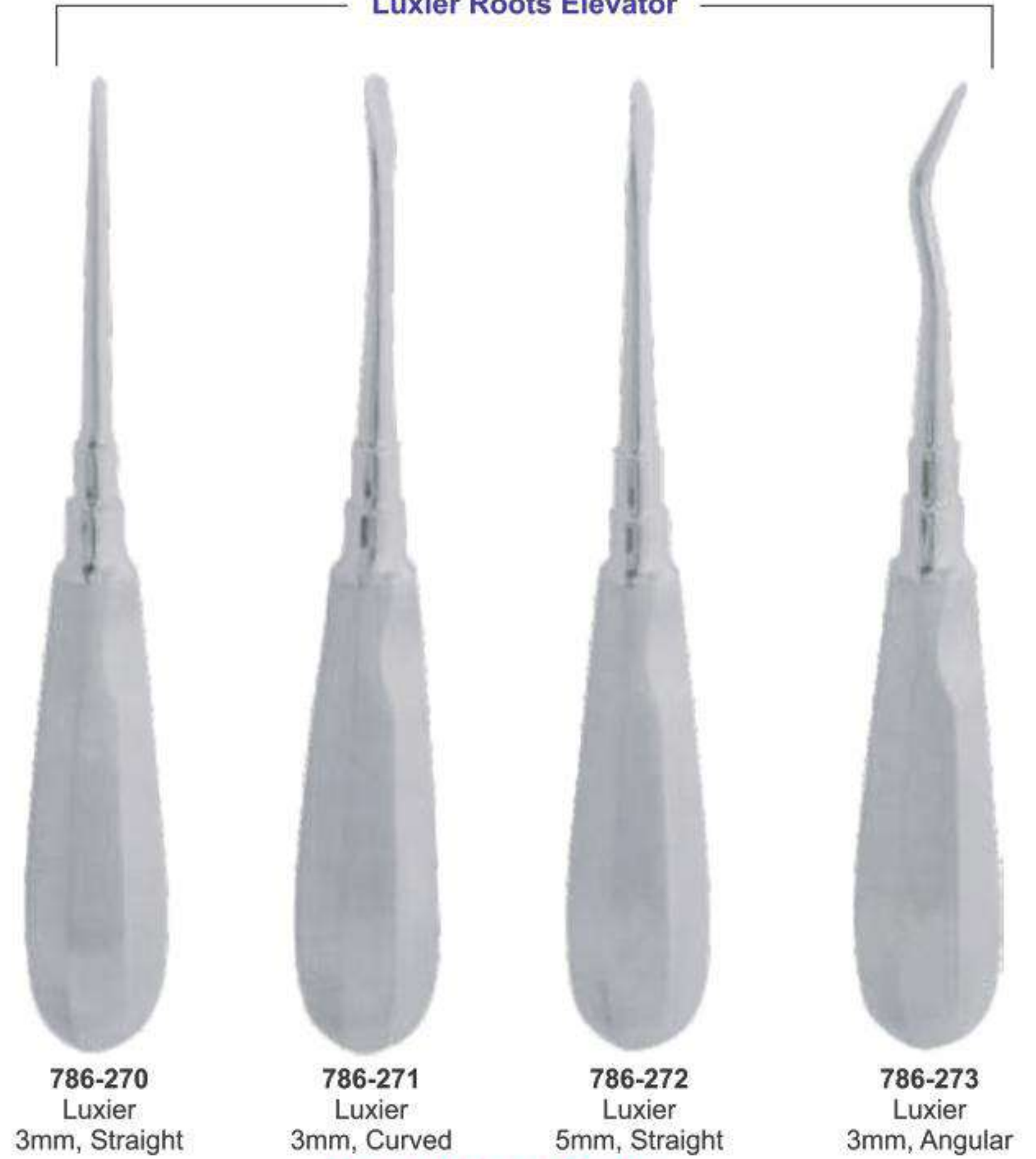

Luxier Roots Elevator



Claw-Lift Roots Elevator



ROOT ELEVATOR

- Элеватор корневой экстракционный
- Elévateurs à racines
- Wurzelheber

- Elevador cornevio extraccionnyy
- Elevadores para raices
- مصاعد الجذر

Hysin Roots Elevator



Cryer Roots Elevator



Kopp Roots Elevator



ROOT ELEVATOR

- Элеватор корневой экстракционный
- Elévateurs à racines
- Wurzelheber

- Elevadores para raíces
- مساعد الجذر

Kopp Roots Elevator



786-295
KOPP
Right

786-296
KOPP
Left

Heber Roots Elevator



786-297
Heber
Bayonet

786-298
Heber
Bayonet

Bein Roots Elevator



786-299
Bein
3mm

786-300
Bein
4mm

Bein Roots Elevator



786-302
2mm
Straight
serrated

786-303
3mm
Straight

786-304
4mm
Curved

786-306
2mm
Straight
serrated

786-307
3mm
Straight

786-308
4mm
Curved

786-310
2mm
Straight
serrated

786-311
3mm
Straight

786-312
4mm
Curved

786-301
Bein
2mm, curved
serrated

786-305
Bein
2mm, curved
serrated

786-309
Bein
2mm, curved
serrated

ROOT ELEVATOR

- Elevator корневой экстракционный
- Elévateurs à racines
- Wurzelheber

- Elevator корневий екстракційний
- Elevadores para raices
- مصاعد الجذر

Seldin Roots Elevator

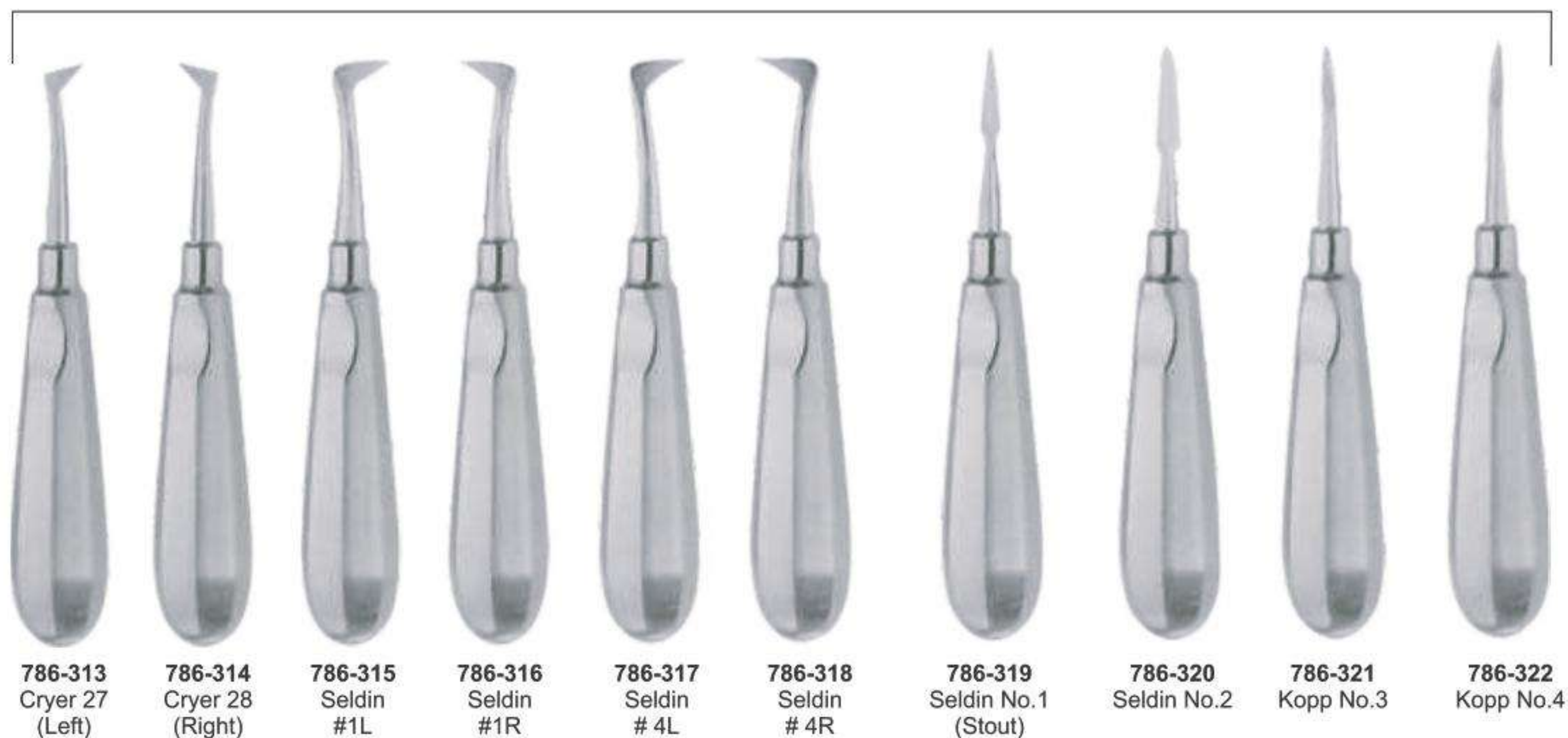

W Barry Roots Elevator



Winter Roots Elevator



Pott Roots Elevator



ROOT ELEVATOR

- Elevator корневой экстракционный
- Elévateurs à racines
- Wurzelheber

- Elevator корневий экстракційний
- Elevadores para raices
- مصاعد الجذر

Heidbrink Roots Elevator

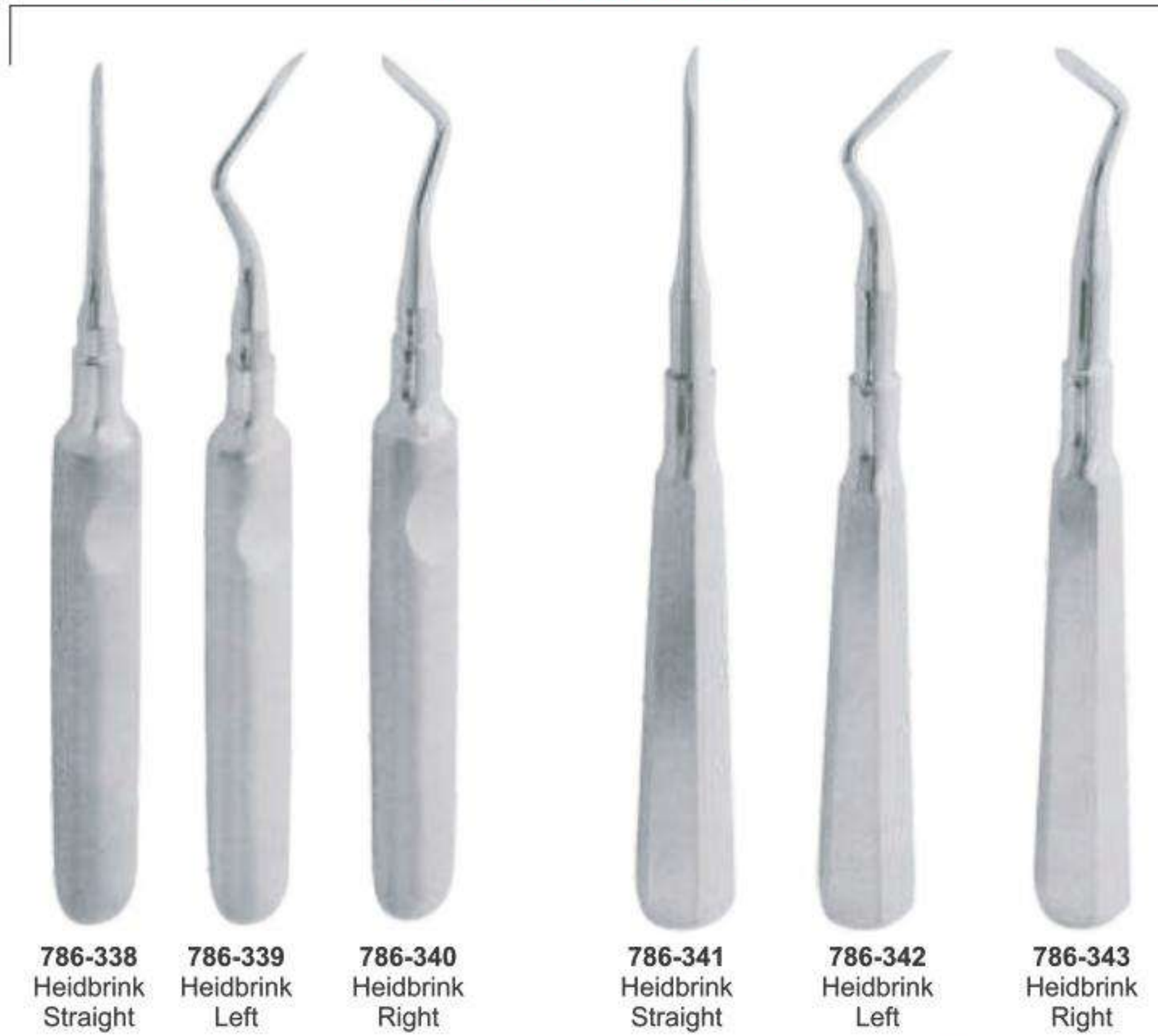

Syndesmotomes Roots Elevator



Periotome Roots Elevator

Syndesmotomes



ROOT ELEVATORS

- Elevator корневой экстракционный
- Elevateurs à racines
- Wurzelheber

- Elevator корневий екстракційний
- Elevadores para raices
- مصاعد الجذر



786-355
1S
(Straight 1mm)



786-356
2S
(Straight 2mm)



786-357
3S
(Straight 3mm)



786-358
5S
(Straight 5mm)



786-359
3C
(Curved 3mm)



786-360
5C
(Curved 5mm)



786-361
3CA
(Curved Angle 3mm)



786-362
3C
(Inverted Curved 3mm)



786-363
DE 3
(Dual Edge 3mm / 1.5mm)



786-364
DE 5
(Dual Edge 5mm / 3mm)

ROOT ELEVATOR

- Элеватор корневой экстракционный
- Elevateurs à racines
- Wurzelheber

- Elevador coronevii ekstraktsionnyi
- Elevadores para raices
- مساعد الجذر

PDL ELEVATORS

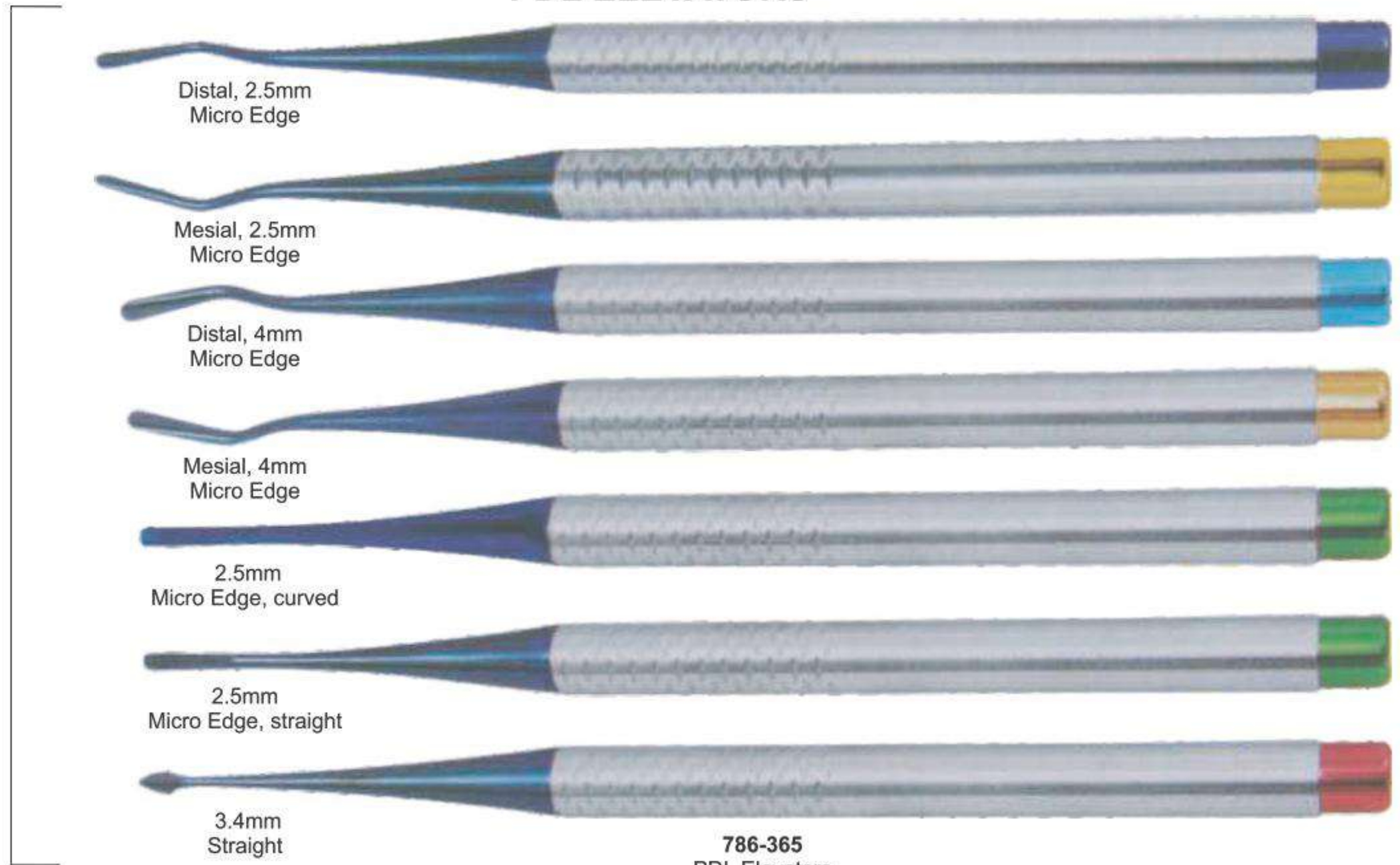

ROOT ELEVATOR

- Элеватор корневой экстракционный
- Elévateurs à racines
- Wurzelheber

- Элеватор корневий экстракційний
- Elevadores para raices
- مصاعد الجذر

PDL ELEVATORS

Delicate Arrow tip

Luxivators straight
Atraumatic luxation of the tooth

Luxivators curved
Atraumatic luxation of the tooth



4,0mm
straight

4,0mm
curved

2,5mm
straight

3,5mm
straight

4,5mm
straight

2,5mm
curved

3,5mm
curved

4,5mm
curved

786-367
PDL Elevators
Set of 8 Pcs

Our Scalers

Compare our scalers and curettes with the best in the industry and you will immediately recognize we are equal in every way but one ...price.

Note the deep precision knurling for better tactile feel. The same high-grade stainless steel tips, The same light weight (under 18 grams) for less hand fatigue, the same professional craftsmanship, and surpassing the highest industry standards. of course, any manufacturer can make these claims, but we guarantee and certify ours.

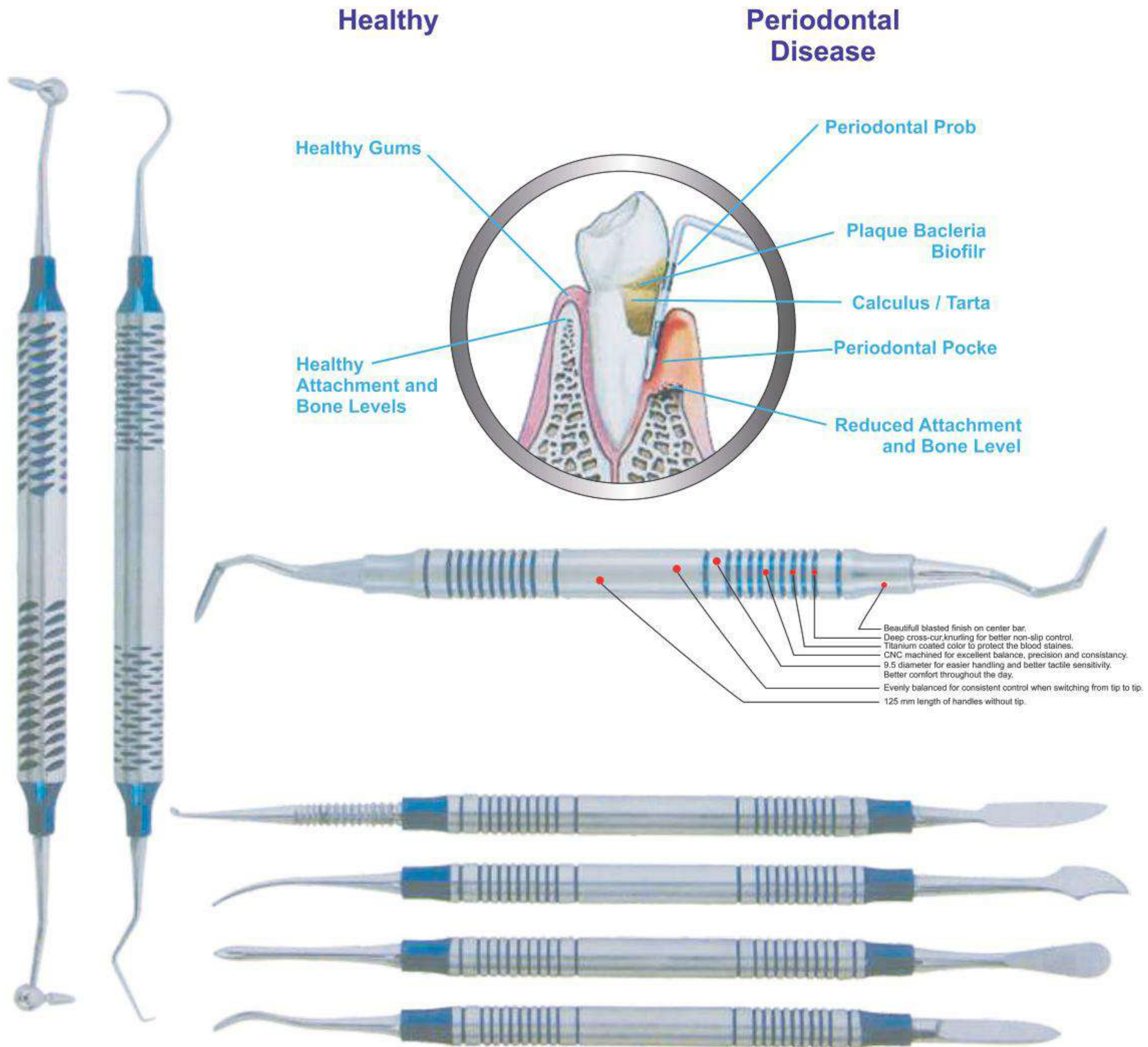

- High-polish mirror finish tips.
- Manufactured within the guidelines of the FDA quality assurance system for good manufacturing practices.
- Highest grade German stainless steel, razor sharp, durable tips. Rockwell hardened to 60 Rhc.
- 27 of the most popular designs from graceys to McCalls to columbias, and many european patterns.
- All Instruments are guaranteed against defects in material and workmanship.

- All instruments bear the ce mark, emblematic of the european community's highest standards.
- Customer satisfaction guarantee, too!
- Less than 20 grams...Lightweight for less hand fatigue.
- Manufactured to the most exacting standards so the 50th instrument you buy is exactly like your first.
- You decide ...Why pay more for the same high-quality instruments?

HANDLES FOR MOUTH MIRRORS

- Ручки для зеркал
- Manches pour miroirs à bouche
- Mundspiegelgriffe

- Ручки для дзеркал
- Mangos para espejos debica
- مقبض مرآيا الفم



Magnifying



Plain



Rhodium

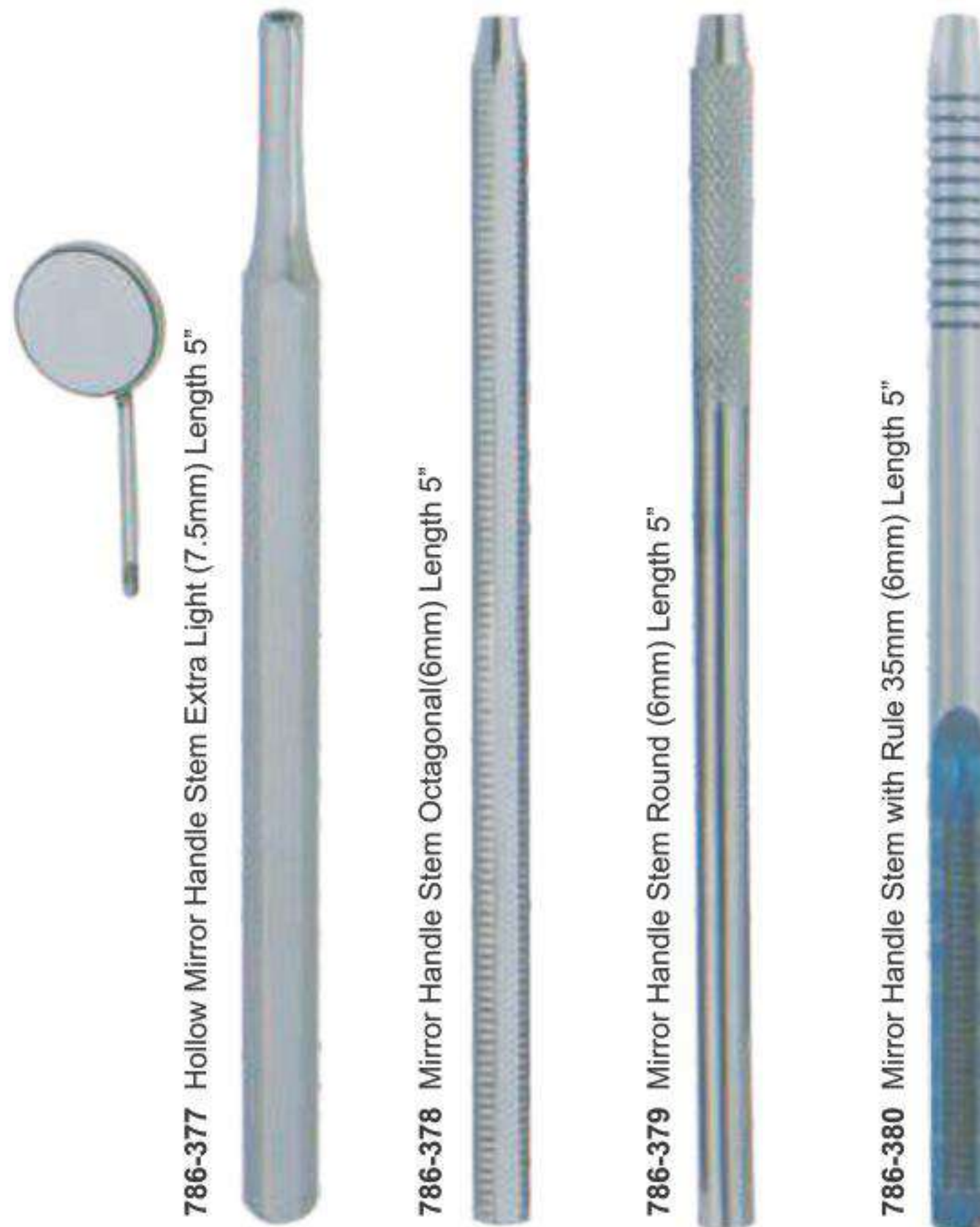
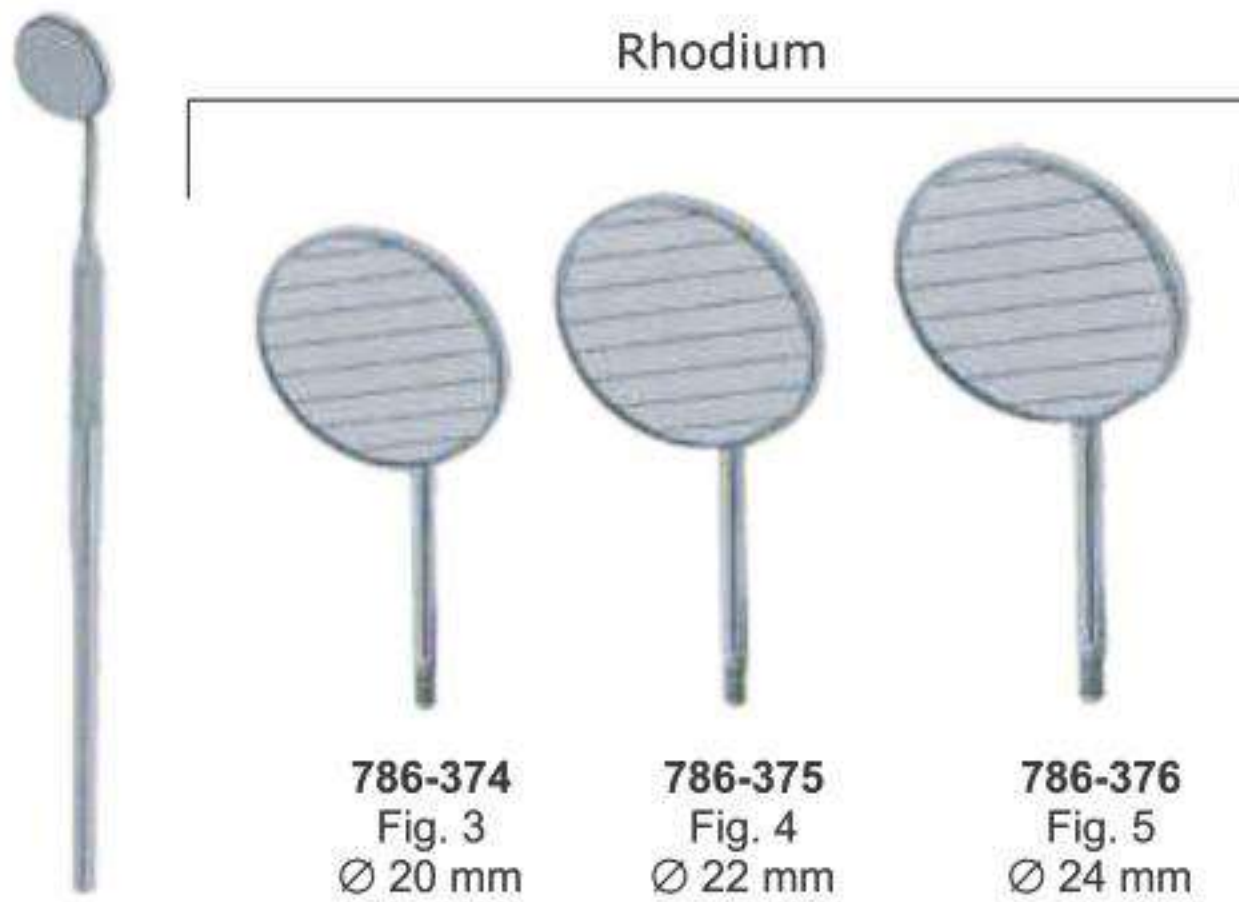

TWEEZERS

- Пинцеты
- Précelles - Brucelles
- Zahnpinzetten

- Пінцети
- Pinzas para algodón
- ملاقط



786-381
Surgical
11.5cm



786-382
London College
15cm



786-383
Semken Taylor
Str.



786-384
Semken Taylor
Cvd.



786-385
Meriam
16cm



786-386
Dressing
14cm



786-387
Semken Taylor
1x2 Straight



786-388
Semken Taylor
1x2 Curved



786-389
Gillies
15cm 1x2



786-390
14cm 1x2



786-391
Perry
13cm



786-392
Atraumatic
15cm Cvd.



786-393
Atraumatic
15cm Str.



786-394
College with Lock
15cm Cvd.



786-395
Gerald
17.5cm



786-396
with Lock
15cm



786-397
Atraumatic
17.5cm

TWEEZERS

- Пинцеты
- Précelles - Brucelles
- Zahnpinzetten

- Пінцети
- Pinzas para algodón
- ملاقط



786-398
Adson-TC
12cm



786-399
Adson-TC
12cm 1x2



786-400
Adson-TC
15cm 1x2



786-401
Adson
12cm



786-402
Adson
12cm 1x2



786-403
Adson
15cm 1x2



786-404
Adson Brown
12cm



786-405
Crane Kaplan
15cm



786-406
Crane Kaplan
15cm



786-407
Crane Kaplan
15cm



786-408
Hemingway
15cm



786-409
Miller
15cm Str.



786-410
Miller
15cm Cvd.



786-411
Dressing Tweezer
14.5cm



786-412
College Curved
Tip 15cm



786-413
Maryam Tweezers
15cm



786-414
College Tweezer
15cm



786-415
Perry Tweezer
12.5cm



786-416
Self-locking
Tweezer
15cm

EXPLORERS

■ Зонды
■ Sondes
■ Zahnsonden

■ Зонди
■ Sondas
■ المستكشفين

Single Ended Probe Solid Handle 4.5mm Length 150mm



Fig. 2
Normal Handle



Single Ended Probe Hollow Handle 8.5mm Length 150mm



Fig. 2
Anatomic Handle

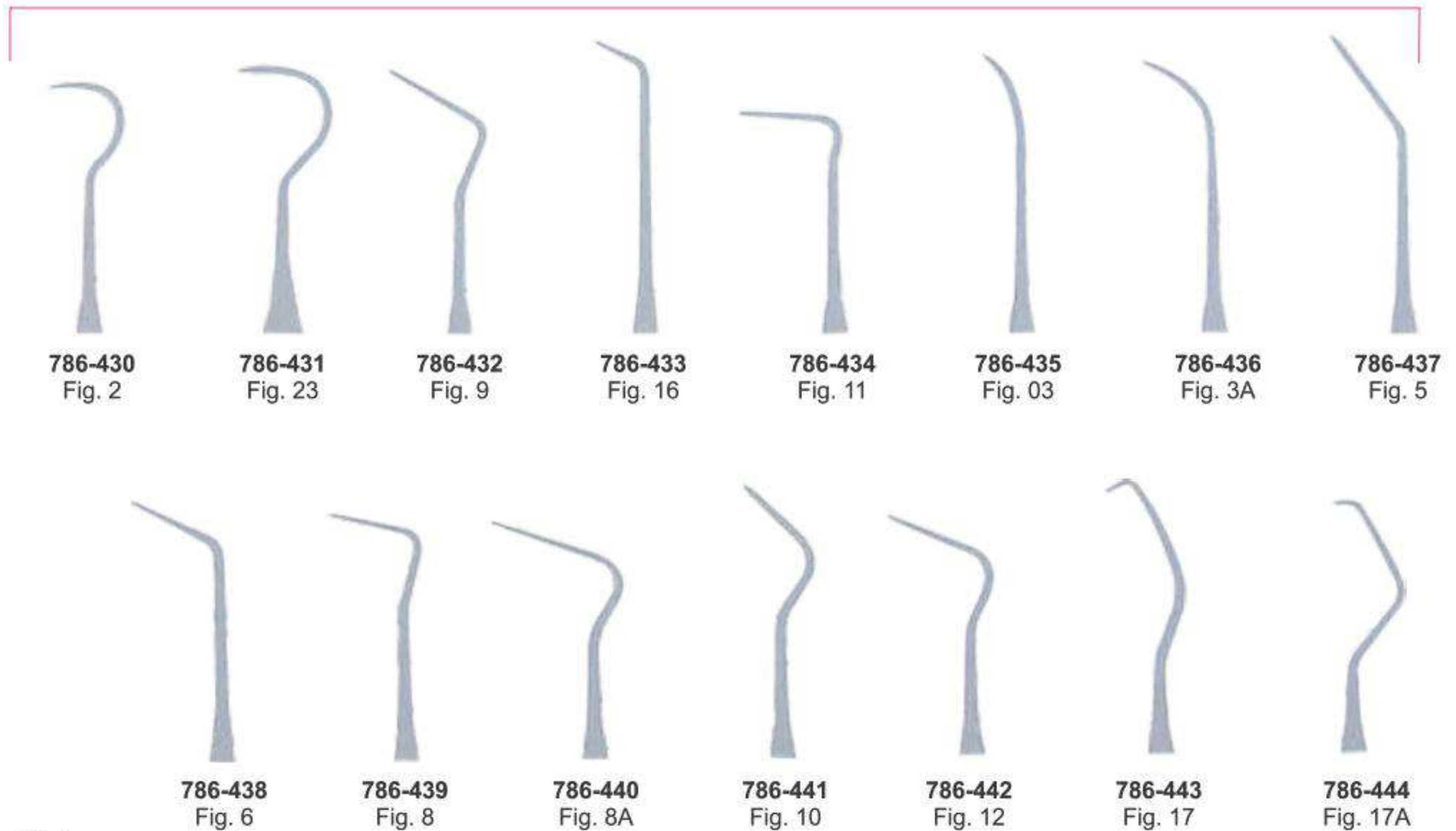

EXPLORERS

- Зонды
- Sondes
- Zahnsonden

- Зонди
- Sondas
- المستكشفين

Probes Single End Solid Handle 6mm, length 150mm



786-445
Fig. 0

786-446
Fig. 8

786-447
Fig. 9

786-448
Fig. 16

786-449
Fig. 23

Probes Single Ended 6mm, length 150mm

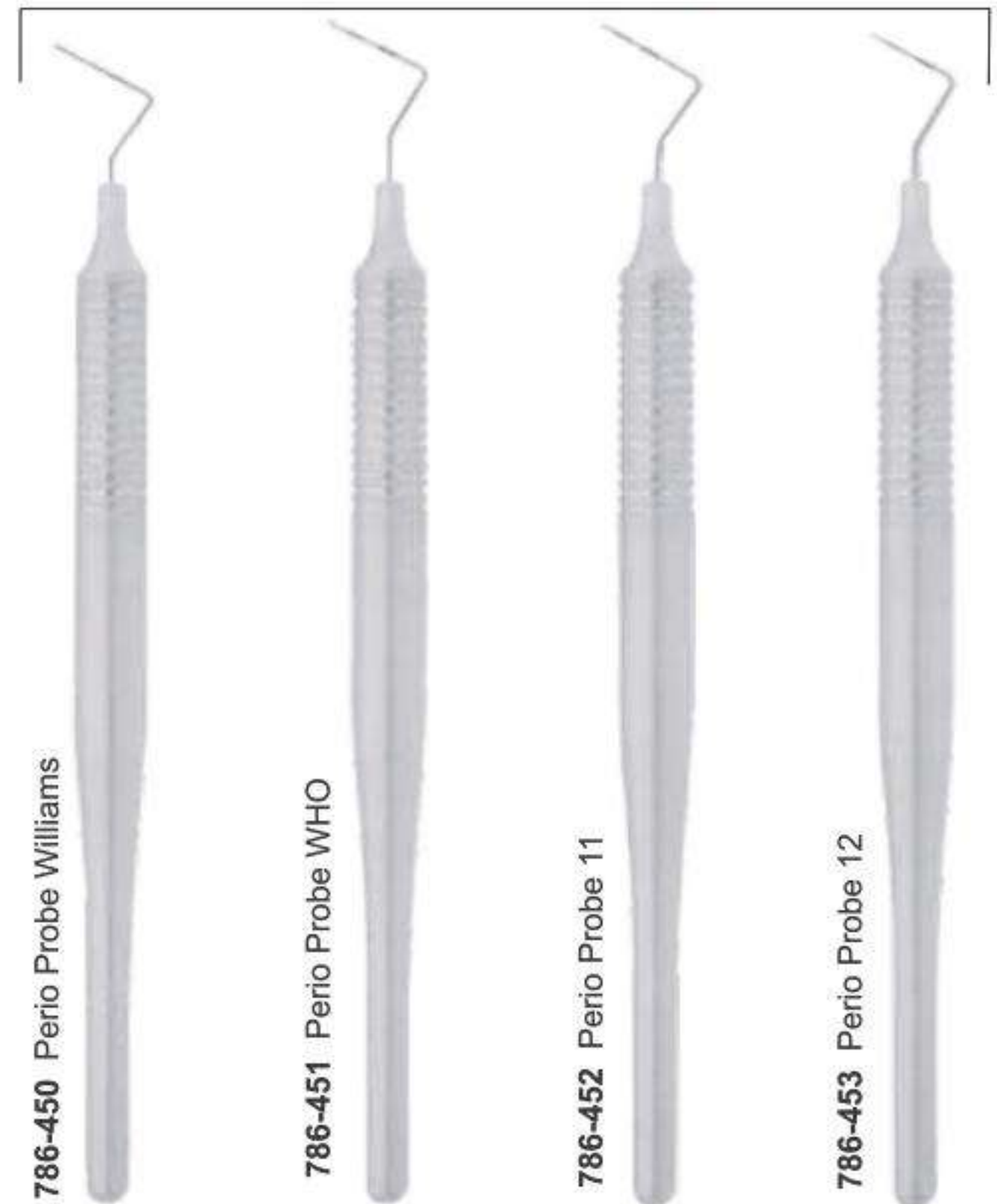

786-450 Perio Probe Williams

786-451 Perio Probe WHO

786-452 Perio Probe 11

786-453 Perio Probe 12

Examination Kit Set of 3 Pieces



786-454
Probe

786-455
Mirror

786-456
College Forcep
15cm

Examination Set of 4 Pieces



Examination Set of 4 Pieces



786-457
Exp,23/17-A

786-458
Excavators

786-459
Tweezers

786-460
Mouth Mirror

EXPLORERS

■ Зонды
■ Sondes
■ Zahnsonden

■ Зонди
■ Sondas
■ المستكشفين

EXPLORERS INSTRUMENTS
SOLID HANDLE 6MM LENGTH 170MM

Double Ended Explorers

Explorers

Explorers
Single End



786-461
23
Shepherd's
Hook
Explorer
#30, #6, #7, #8

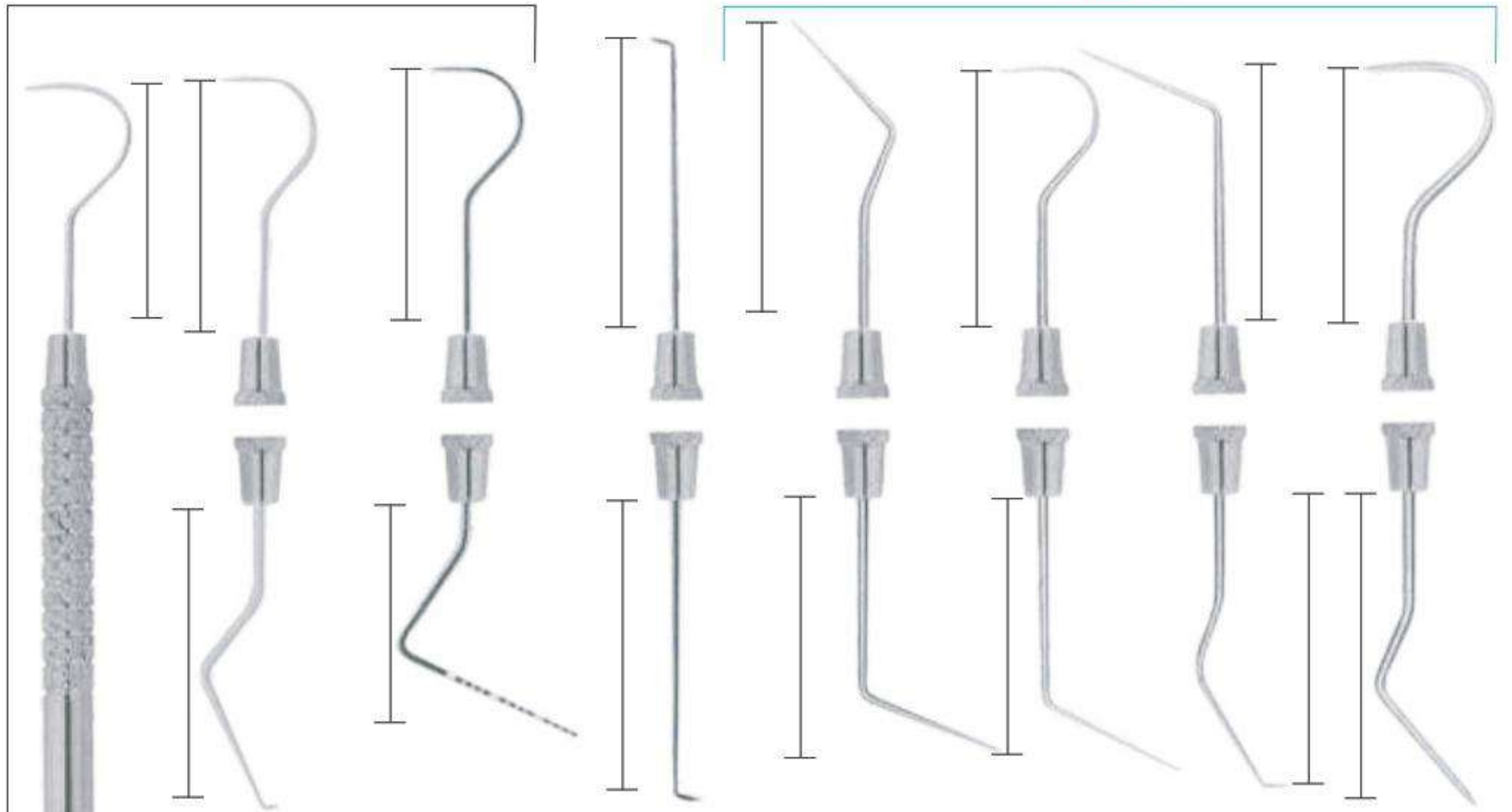

786-463
TU 17/23
Wilkins/Tutts
Explorer
#6

786-464
23UNC1
University of North
carolina
Explorer #31, #6, #7, #8

786-465
1
#31, #6

786-466
DG 16
#31, #6, #7
Thick, #6

786-467
DG 16/23

786-468
DG 16/17

786-469
1
Abou-Rass
Explorers

Probes Double Ended 6mm, length 170mm

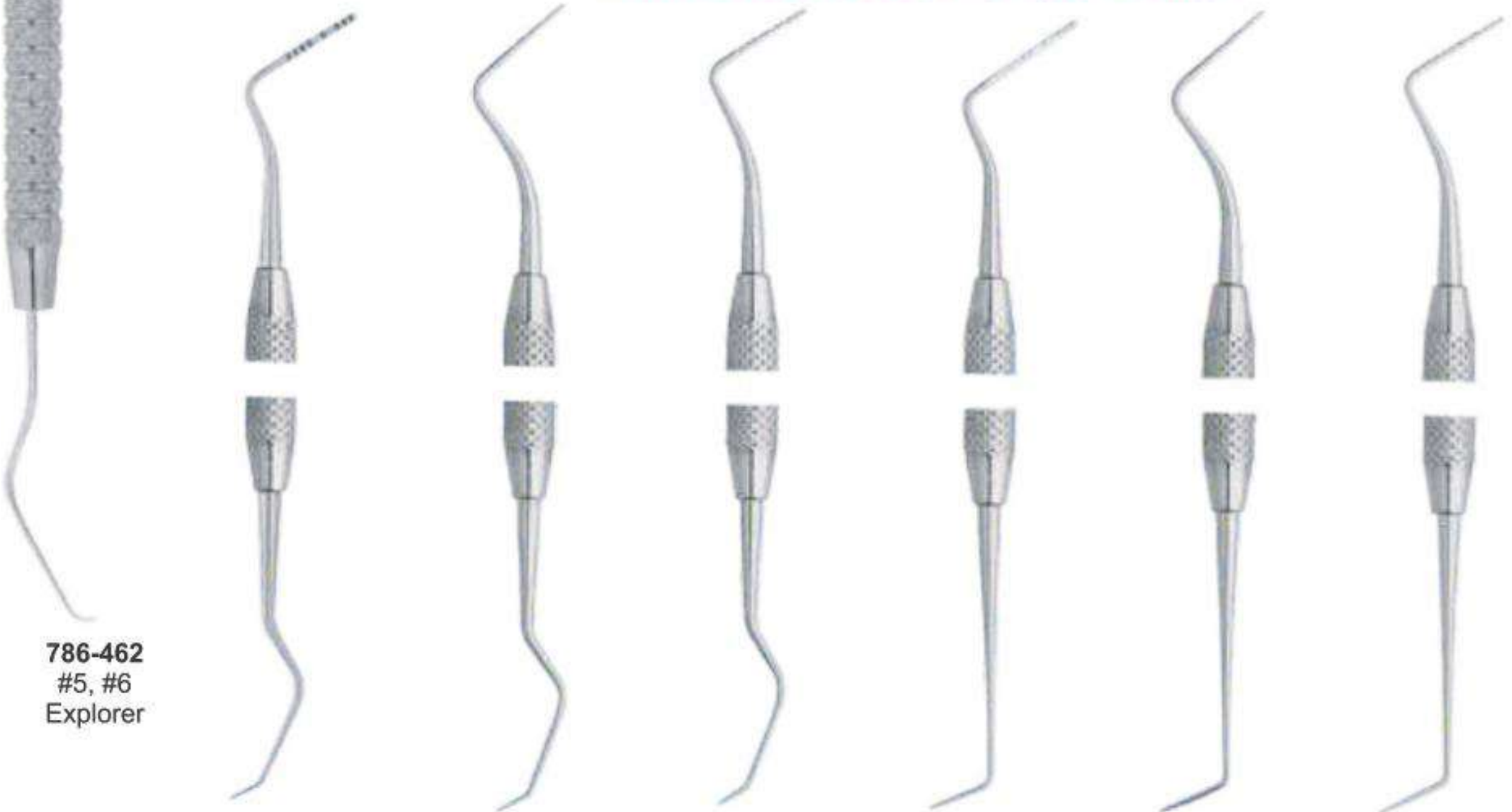

786-462
#5, #6
Explorer

786-470
Goldman Fox
Fig. 17

786-471
University
of Michigan
Fig. 17

786-472
Williams
Fig. 17

786-473
Goldman Fox
Fig. 16

786-474
University
of Michigan
Fig. 16

786-475
Williams
Fig. 16

EXPLORERS

■ Зонды
 ■ Sondes
 ■ Zahnsonden

■ Зонди
 ■ Sondas
 ■ المستكشفين

Pointed Probes Single Ended Handle 6mm, length 150mm



Pointed Probes Single Ended Handle 6mm, length 170mm

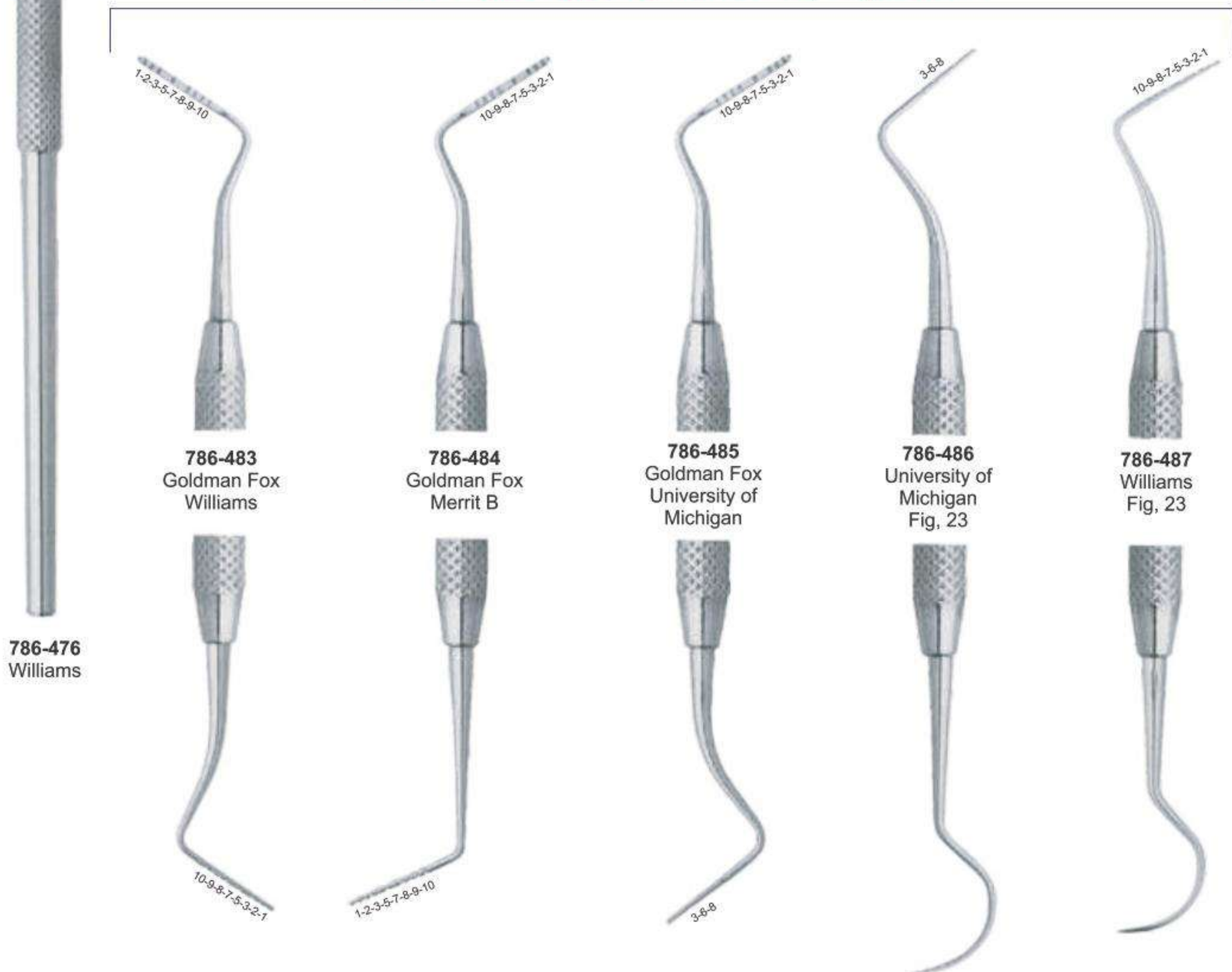

PERIODONTAL INSTRUMENTS

- Инструменты пародонтологические
- Instruments pour la parodontologie
- Instrumente für die parodontologie

- Інструменти пародонтологічні
- Instrumentos para periodoncia
- الصكوك اللثة

PERIODONTAL SET OF 10 PIECES SOLID HANDLE 6MM LENGTH 170MM



EXPLORERS

■ Зонды
■ Sondes
■ Zahnsonden

■ Зонди
■ Sondas
■ المستكشفين

WILLIAM PROBE SET DOUBLE ENDED WITH HOLLOW HANDLE 9.5MM, LENGTH 170MM
CERMIC COATED HANDLE

Proper care must be given during cleaning, sharpening and sterilization to preserve design and integrity and to prolong usefulness. Do not expose instruments to sterilization temperatures above 350 F/177 C or to higher than recommended chemical concentrations.



786-498 EXP,23/CO,QW



786-499 EXP,23/CP,10



786-500 EXP,23/CP,18



786-501 EXP,23/CP,12



786-502 EXP,23/CP,2



786-503 EXP,23/UNC,15



786-504 EXP,23/CP,11



786-505 EXP,23/CP,12,S

PERIODONTAL INSTRUMENTS

■ Инструменты пародонтологические
■ Instruments pour la parodontologie
■ Instrumente für die parodontologie

■ Инструменти пародонтологічні
■ Instrumentos para periodoncia
■ الصكوك اللثة

PERIODONTAL INSTRUMENTS SET OF 11 PCS
SOLID HANDLE 6MM, LENGTH 170MM



CURETTES

■ Кюрети
■ Curetas
■ Küretten

■ Кюрети
■ Curette
■ کرتس

GRACEY SET OF 7 PCS HOLLOW HANDLE 9.5MM, LENGTH 170MM

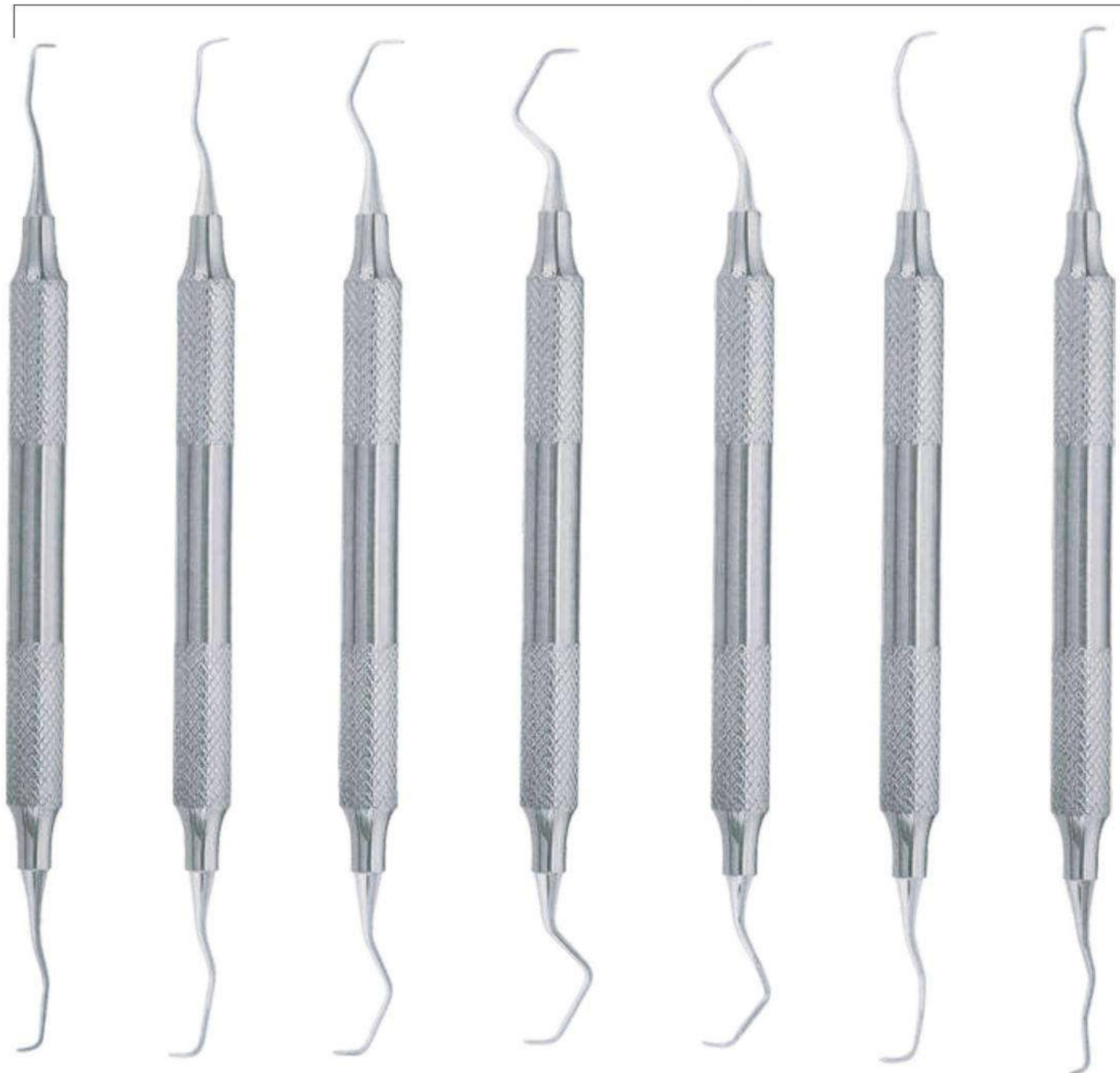

786-517
GRACEY
1/2

786-518
GRACEY
3/4

786-519
GRACEY
5/6

786-520
GRACEY
7/8

786-521
GRACEY
9/10

786-522
GRACEY
11/12

786-523
GRACEY
13/14

CURETTES

■ Кюрети
■ Curetas
■ Küretten

■ Кюрети
■ Curette
■ کرتس

GRACEY SET OF 7 PCS
HOLLOW HANDLE 9.5MM, LENGTH 170MM WITH SILICON GRIP

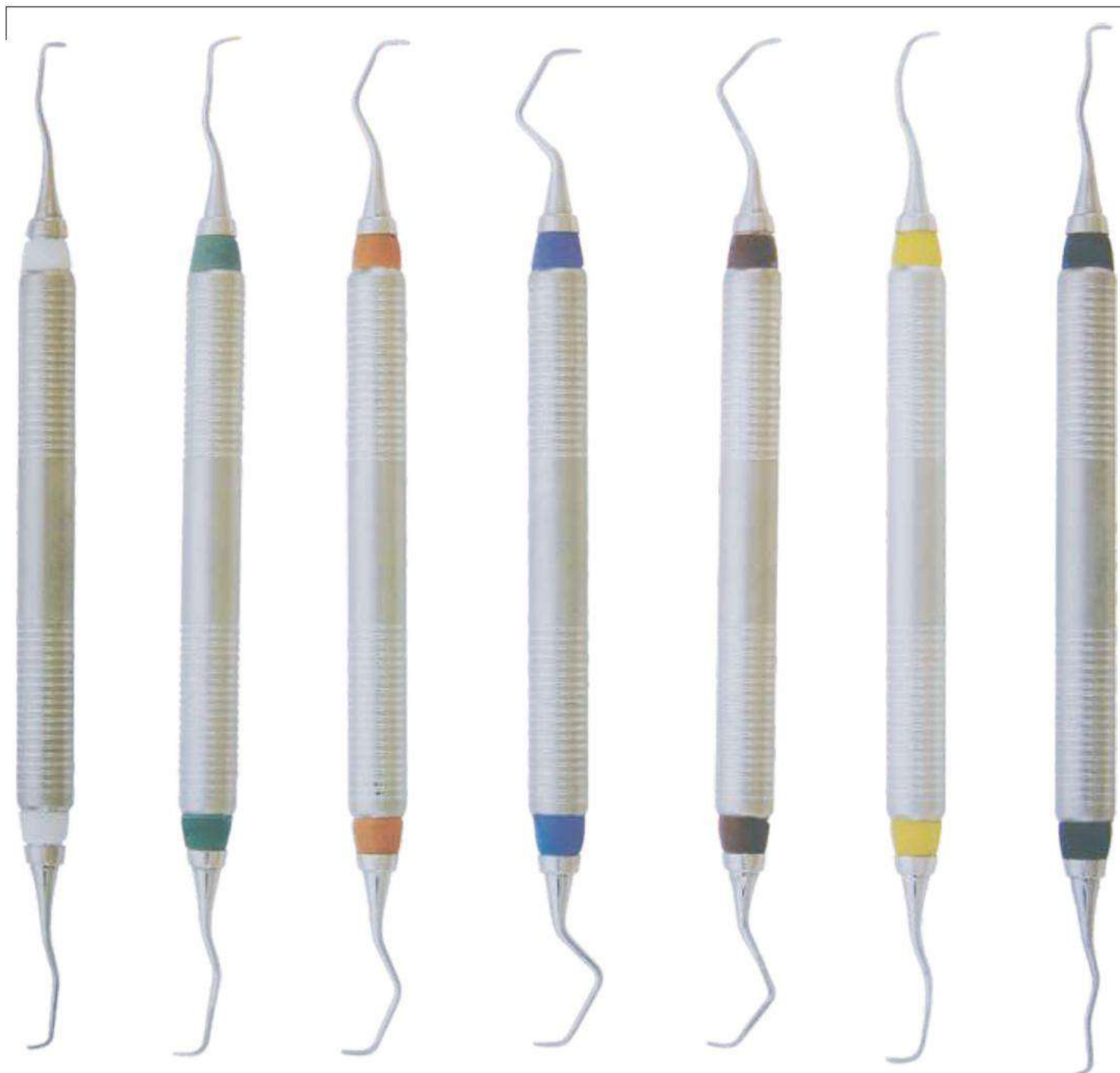

786-524
GRACEY
1/2

786-525
GRACEY
3/4

786-526
GRACEY
5/6

786-527
GRACEY
7/8

786-528
GRACEY
9/10

786-529
GRACEY
11/12

786-530
GRACEY
13/14

CURETTES

■ Кюрети
■ Curetas
■ Küretten

■ Кюрети
■ Curette
■ کرتس

GRACEY MINI FIVE

HOLLOW HANDLE 9.5MM, LENGTH 170MM
CERAMIC COATED HANDLE



786-531 Gracey 1/2
786-532 Gracey 3/4
786-533 Gracey 5/6
786-534 Gracey 7/8
786-535 Gracey 11/12
786-536 Gracey 13/44

GRACEY AFTER FIVE

HOLLOW HANDLE 9.5MM, LENGTH 170MM
CERAMIC COATED HANDLE

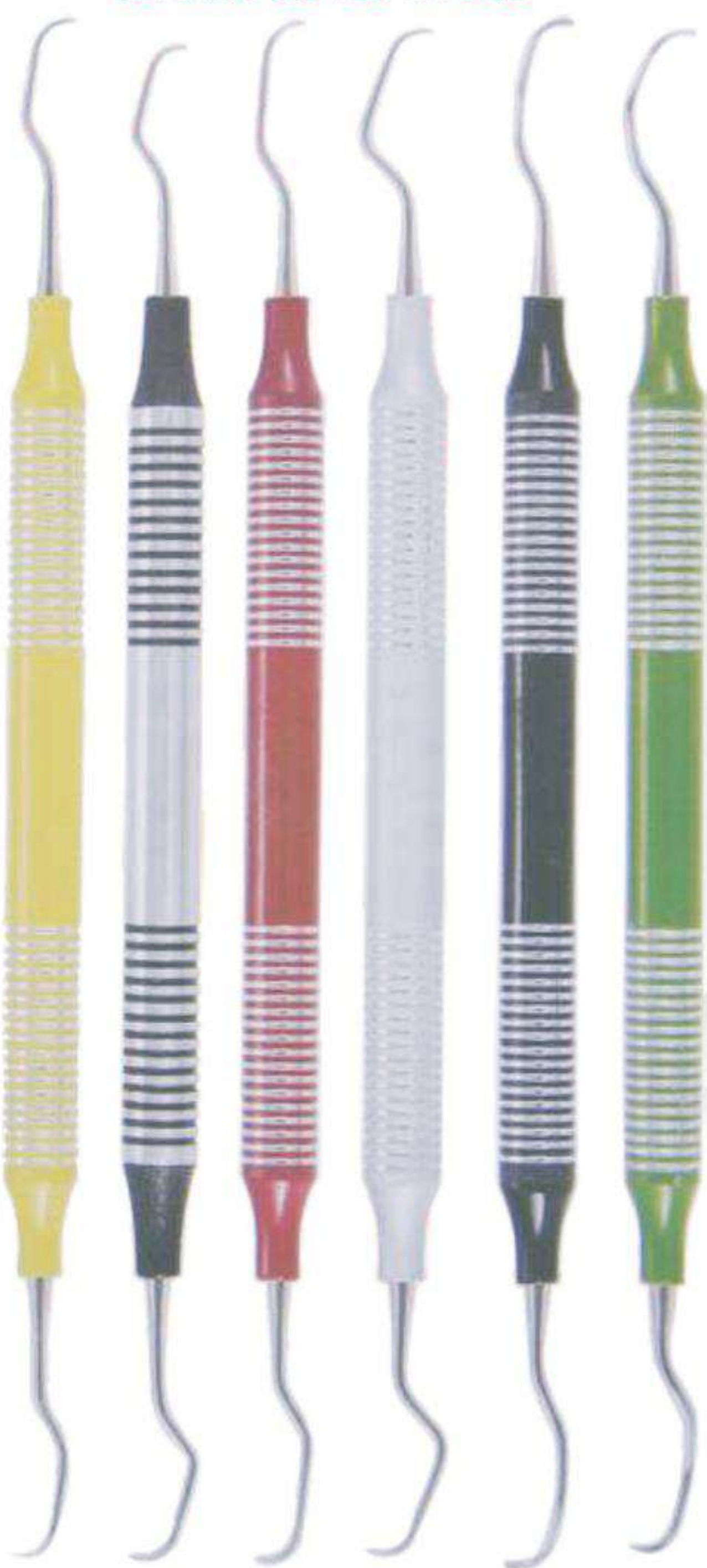

786-537 Gracey 1/2 AF
786-538 Gracey 3/4 AF
786-539 Gracey 5/6 AF
786-540 Gracey 7/8 AF
786-541 Gracey 11/12 AF
786-542 Gracey 13/14 AF

Proper care must be given during cleaning, sharpening and sterilization to preserve design and integrity and to prolong usefulness. Do not expose instruments to sterilization temperatures above 350 F/177 C or to higher than recommended chemical concentrations.

CURETTES

■ Кюрети
■ Curetas
■ Küretten

■ Кюрети
■ Curette
■ کرتس

GRACEY CURETTE HOLLOW HANDLE 10MM, LENGTH 170MM

Curettes Set of 8 Pieces

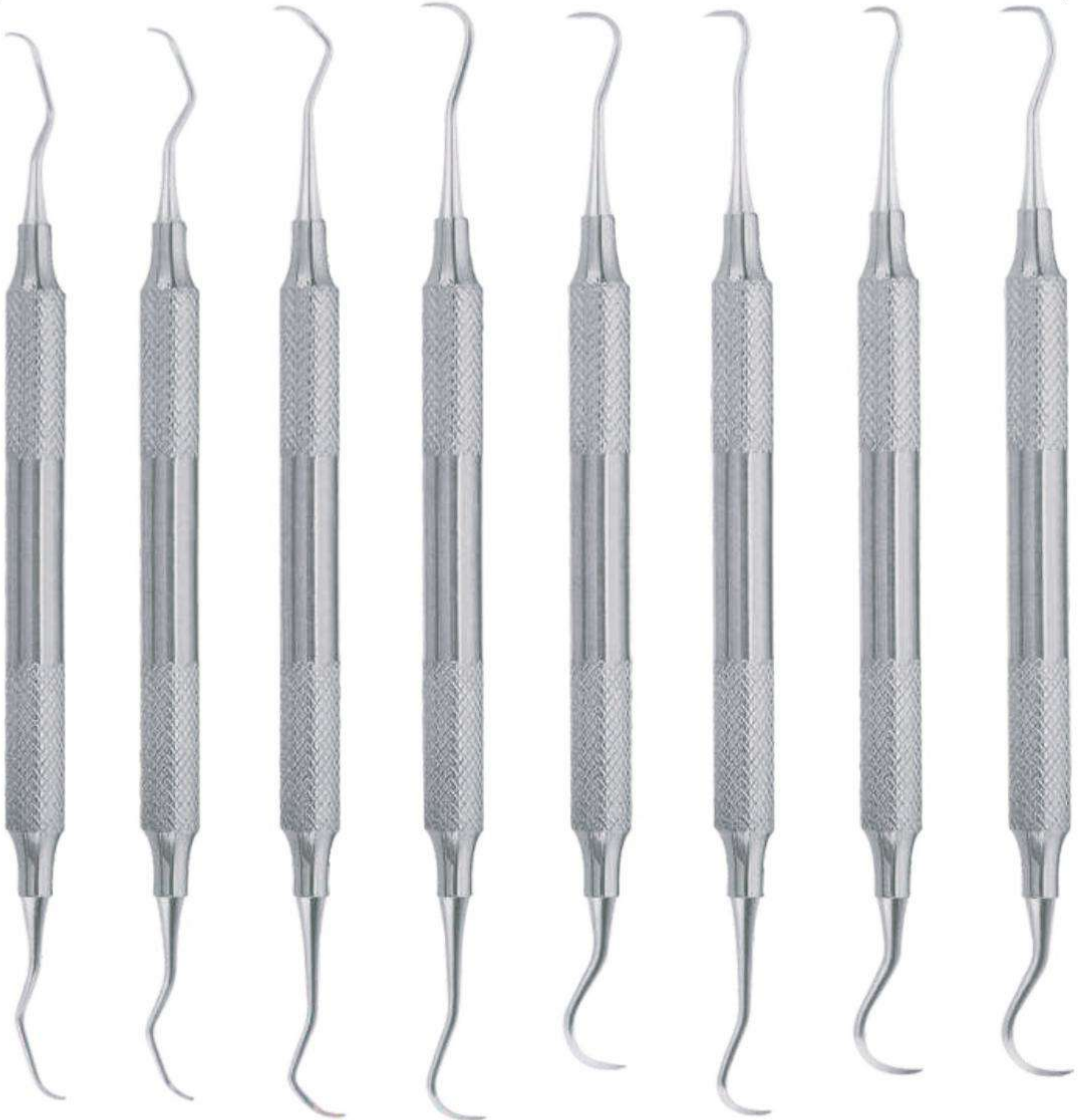

786-543
Curette
Columbia
2L-2R

786-544
Curette
Columbia
4L-4R

786-545
Curette
McCall
13S-14S

786-546
H6-H7
Scaler
Sickle

786-547
H5-U15
Scaler
Sickle

786-548
H5-13
Scaler
Sickle

786-549
U15-30
Scaler
Sickle

786-550
U15-33
Scaler
Sickle

FILLING INSTRUMENTS

- Инструменты для реставрации
- Instruments pour plombage
- Füllungsinstrumente (mit Kontrawinkel)

- Інструменти для реставрації
- Instrumentos para obturaciones
- ملء الصكوك

FILLING INSTRUMENTS (Gold Pointed)
SOLID HANDLE 6MM, LENGTH 170MM

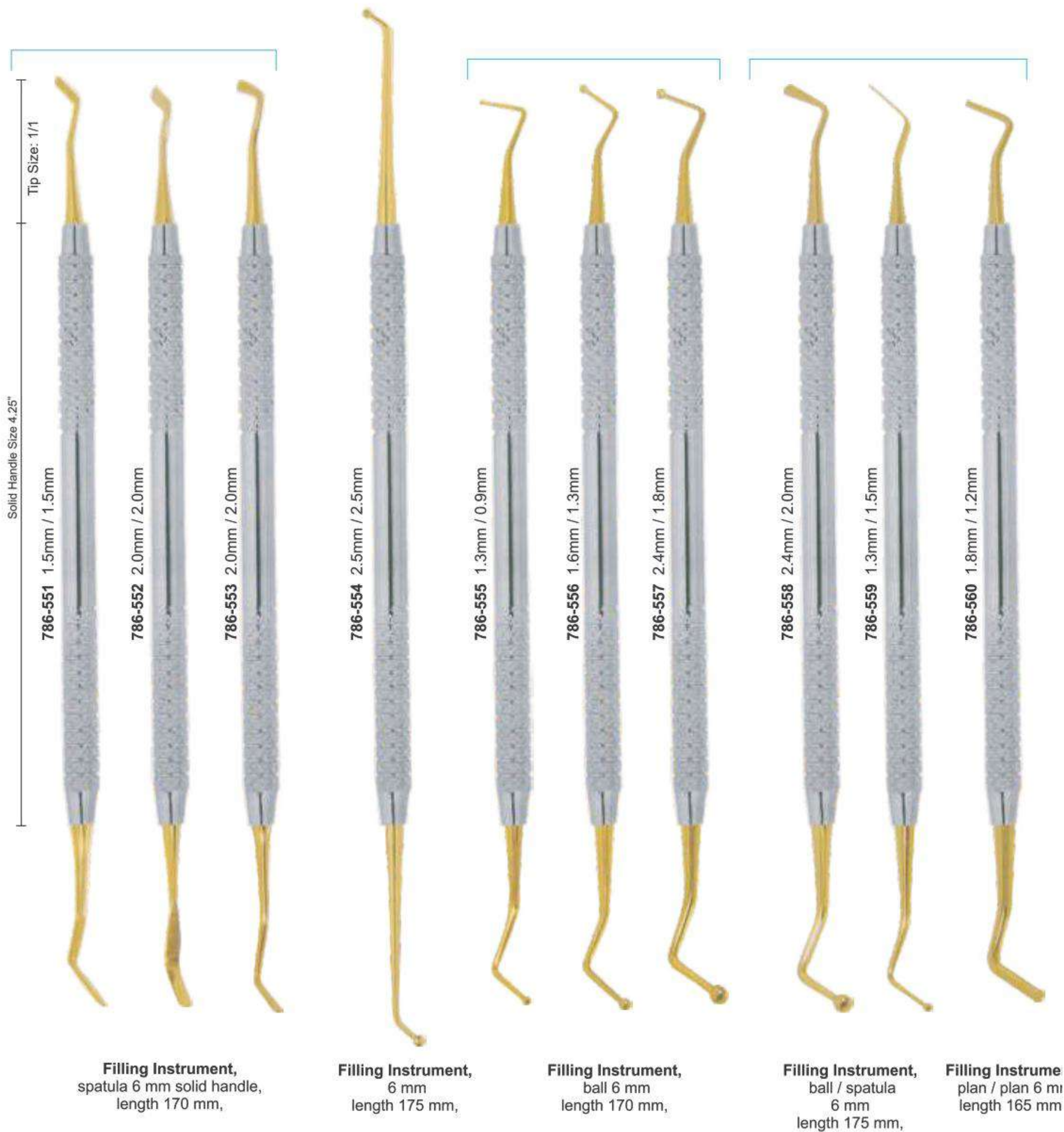

EXPLORERS

■ Зонды
■ Sondes
■ Zahnsonden

■ Зонди
■ Sondas
■ المستكشفين

EXPLORERS INSTRUMENTS SOLID HANDLE 6MM, LENGTH 170MM

PLUGGERS

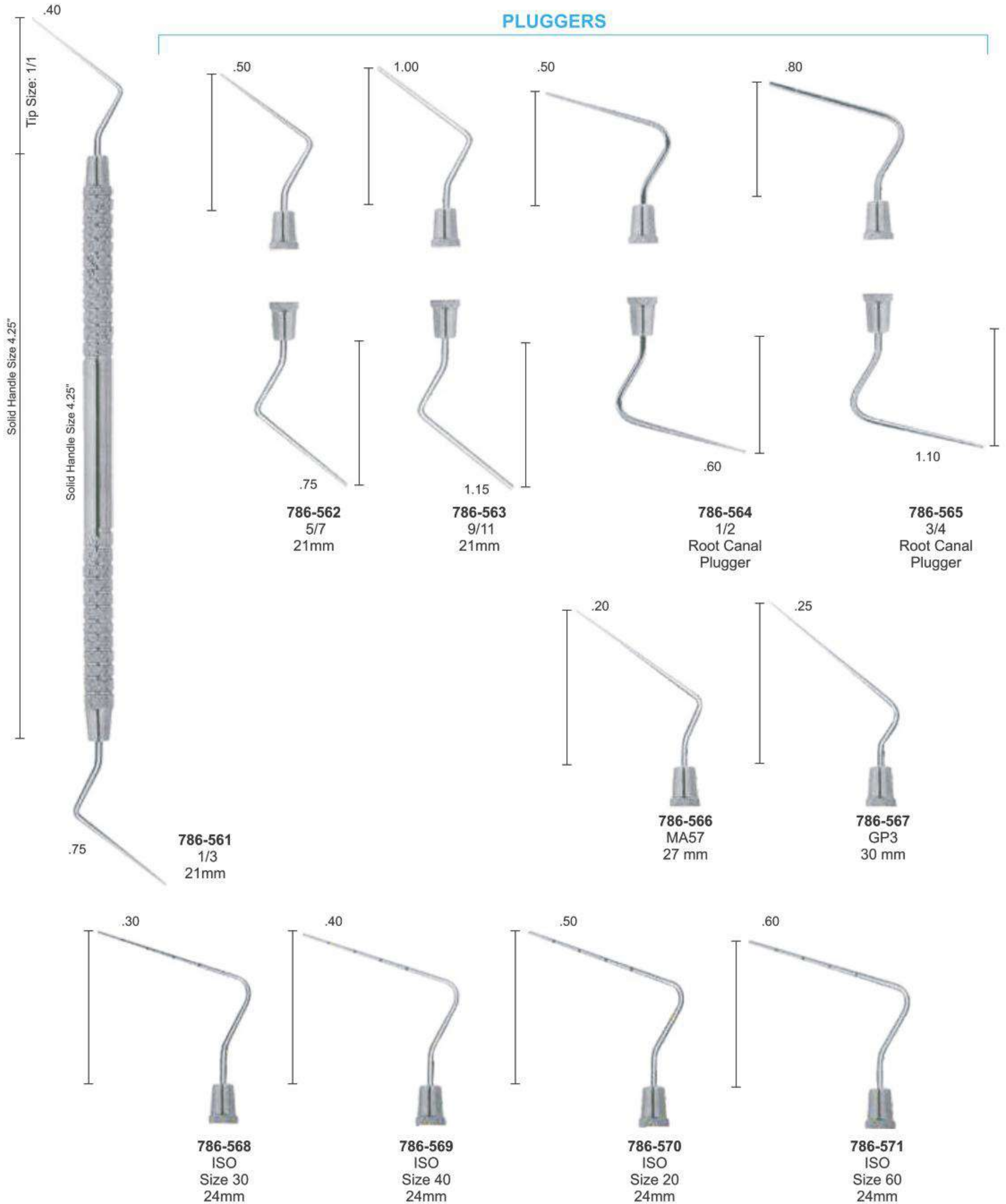

PERIODONTAL PROBES

■ Зонды пародонтологические
 ■ Sondes paradontales
 ■ Sonde paradontali

■ зонди пародонтологічні
 ■ Sondas paradontales
 ■ المسابرة اللثة

SPREADERS

HEAT CARRIERS



HEAT CARRIERS



786-572
 ISO
 Size 30
 24mm

PERIODONTAL PROBES

- Зонды пародонтологические
- Sondes parodontales
- Sonde parodontali

- зонди пародонтологічні
- Sondas parodontales
- المسابير اللثة

ENDODONTICS INSTRUMENTS

ANTERIOR



786-587
8A
29mm

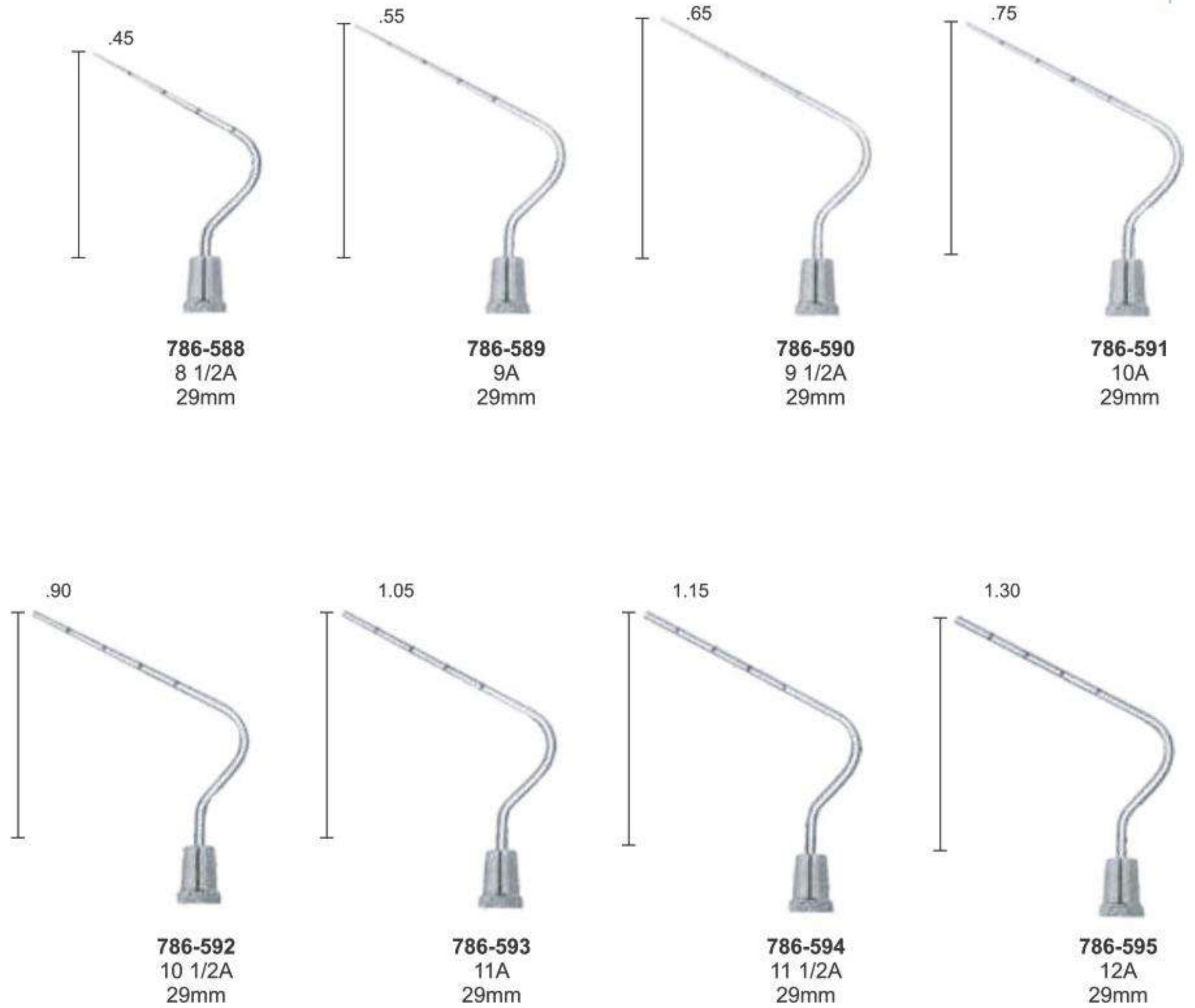

786-588
8 1/2A
29mm

786-589
9A
29mm

786-590
9 1/2A
29mm

786-591
10A
29mm

786-592
10 1/2A
29mm

786-593
11A
29mm

786-594
11 1/2A
29mm

786-595
12A
29mm

LUKS



786-596
L1
18mm

786-597
L2
18mm

786-598
L3
18mm

786-599
L4
18mm

PERIODONTAL PROBES

- Зонды пародонтологические
- Sondes parodontales
- Sonde parodontali

- зонди пародонтологічні
- Sondas parodontales
- المسابير اللثة

ENDODONTICS INSTRUMENTS SOLID HANDLE 6MM, LENGTH 170MM

POSTERIOR

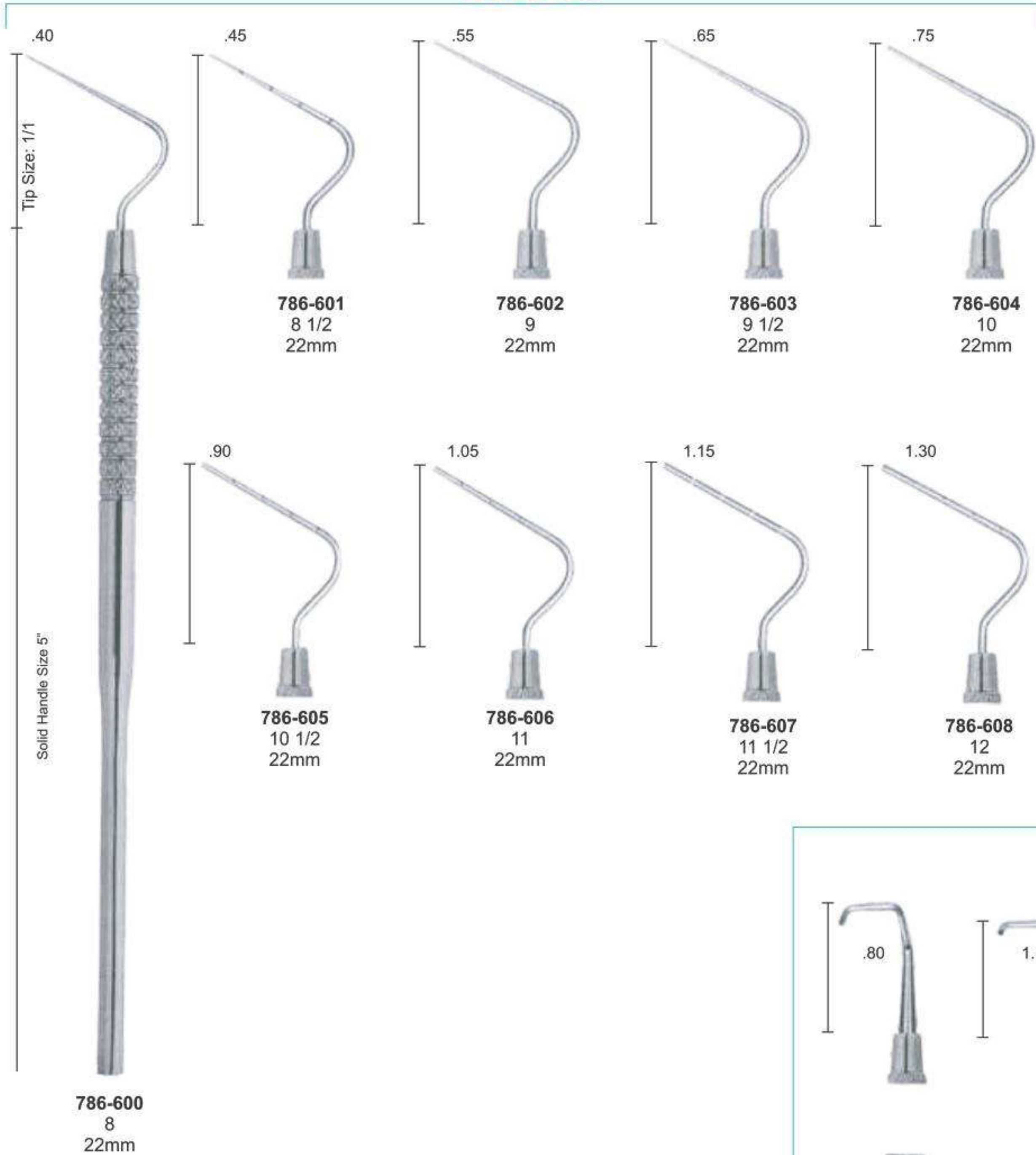

RETRO FILLING PLUGGERS

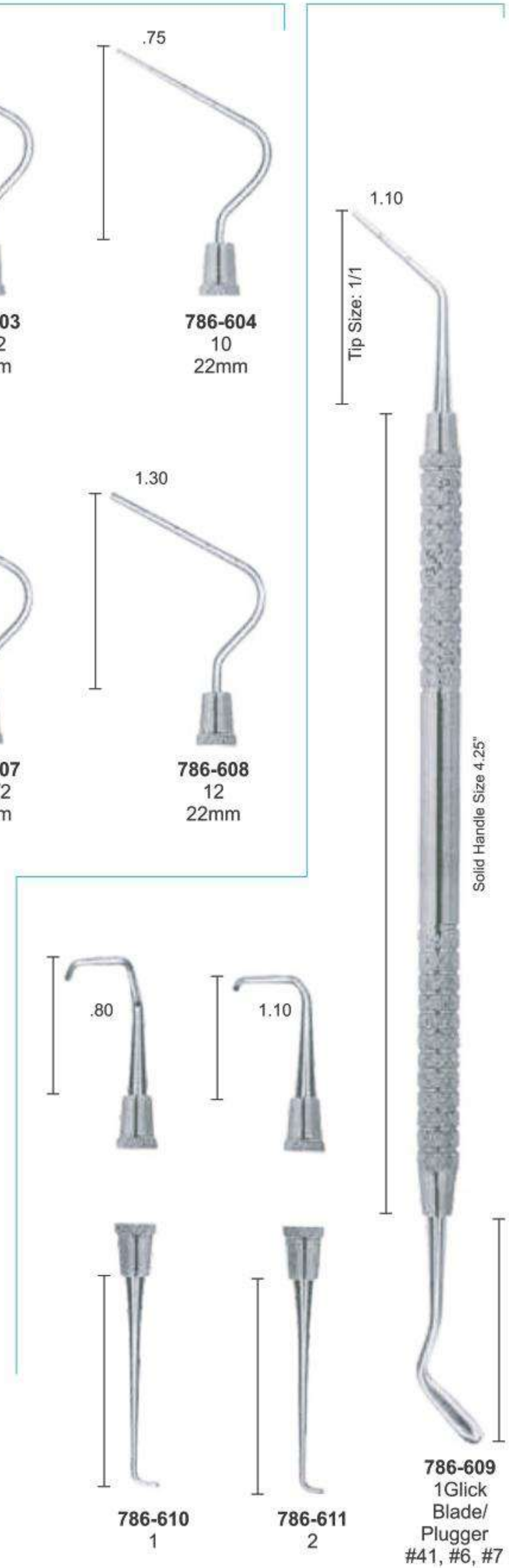

FILLING INSTRUMENTS

■ Инструменты для реставрации
 ■ Instruments pour plombage
 ■ Füllungsinstrumente (mit Kontrawinkel)

■ Инструменти для реставрації
 ■ Instrumentos para obturaciones
 ■ ملء الصكوك

COMPOSITE/PLASTIC FILLING INSTRUMENTS SOLID HANDLE 6MM, LENGTH 170MM

POSTERIOR

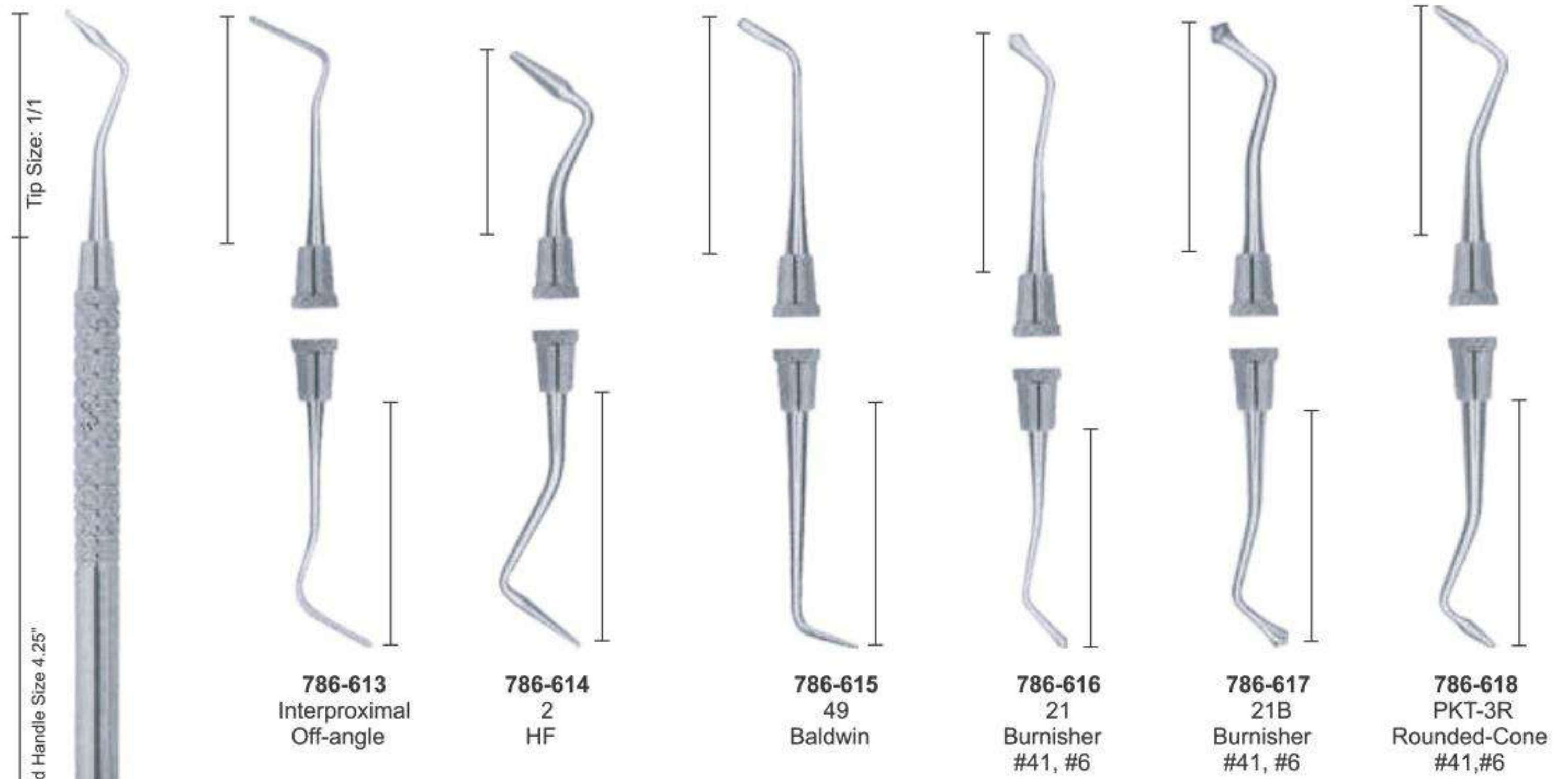

UNIVERSAL FILLING INSTRUMENTS

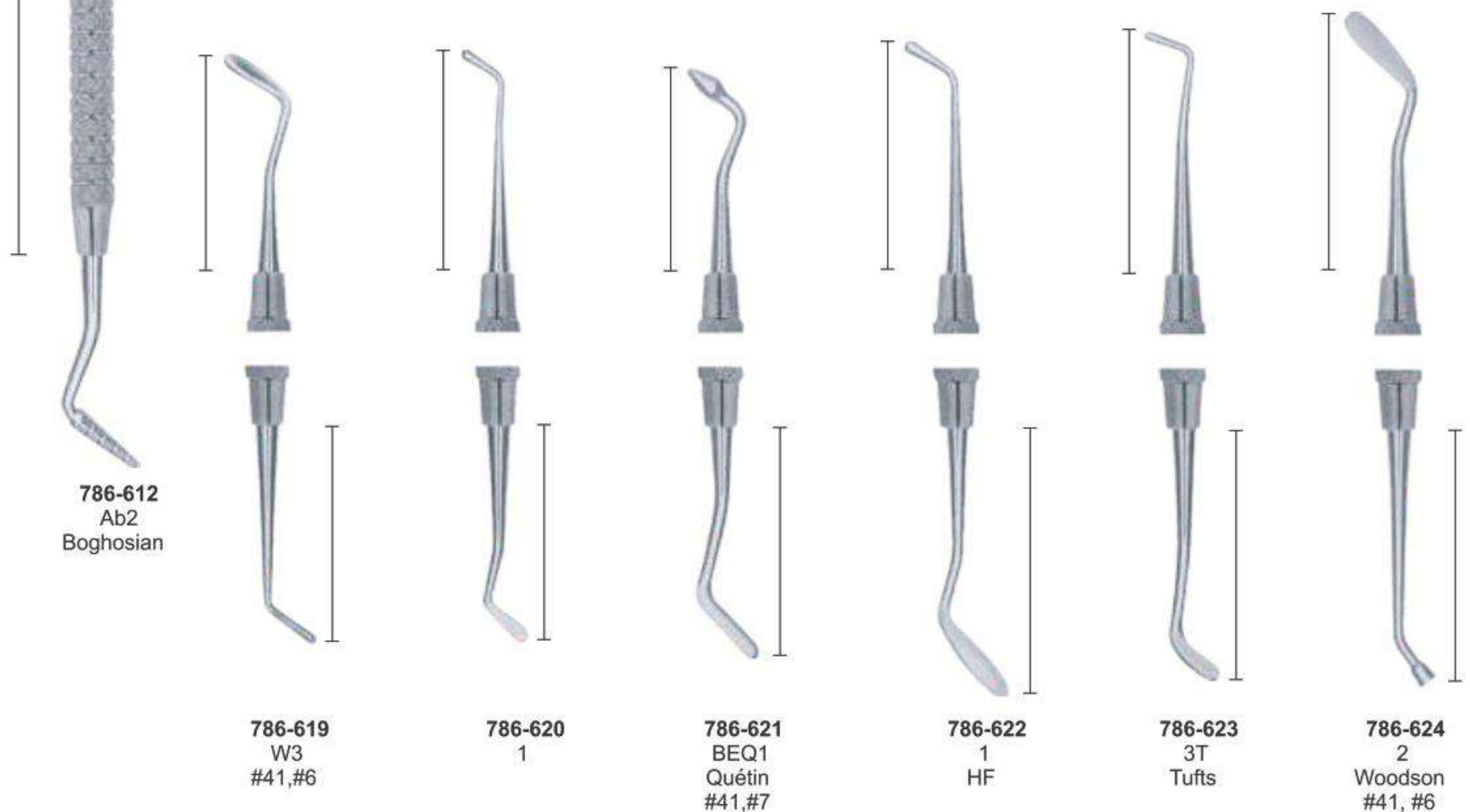

FILLING INSTRUMENTS

- Инструменты для реставрации
- Instruments pour plombage
- Füllungsinstrumente (mit Kontrawinkel)

- Інструменти для реставрації
- Instrumentos para obturaciones
- ملء الصكوك

COMPOSITE/PLASTIC FILLING INSTRUMENTS SOLID HANDLE 6MM, LENGTH 170MM

BLACK

PLUGGERS/CONDENSERS

Hollenback

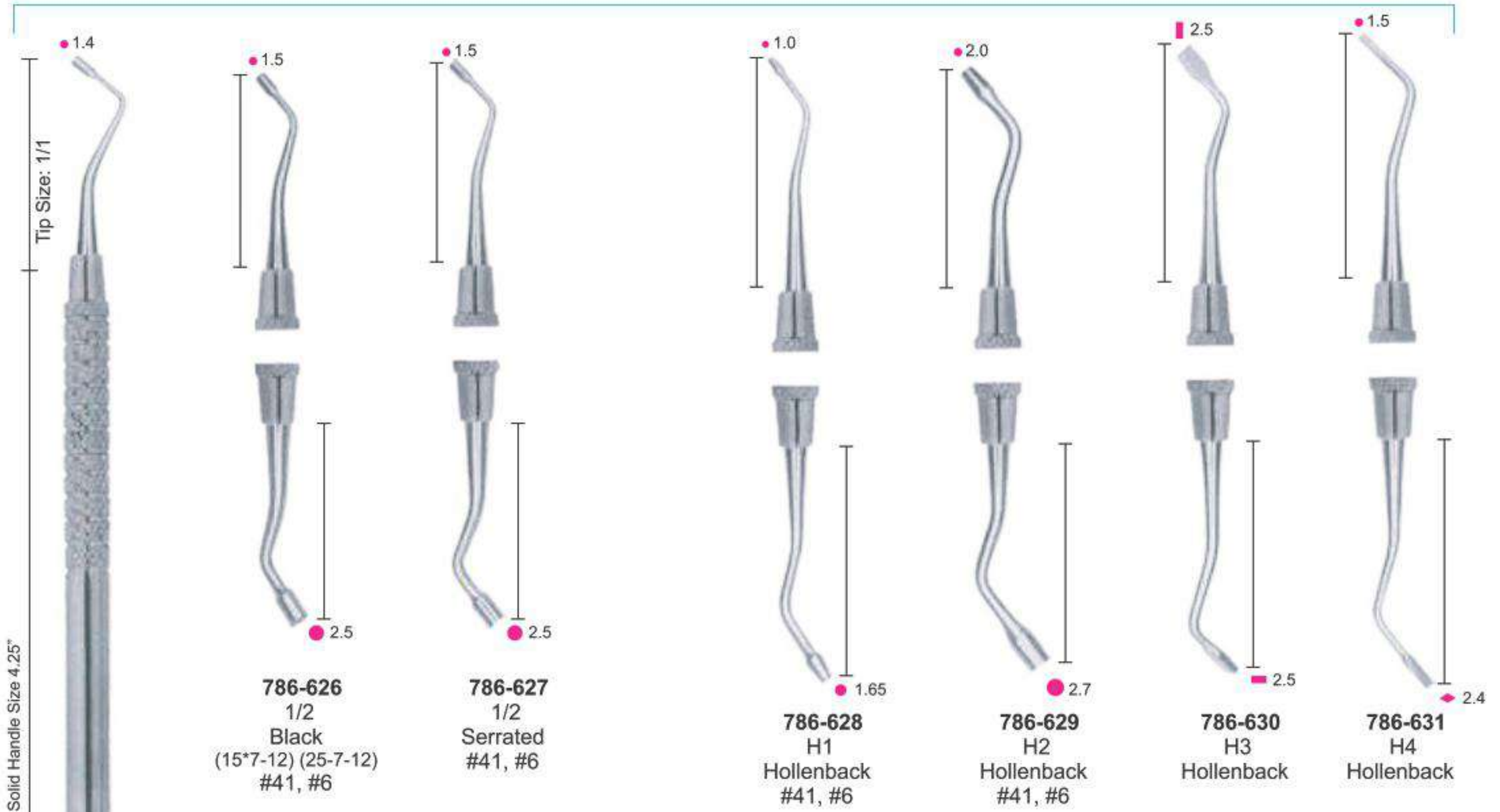

MARQUETTE CONDENSER

MORTONSON

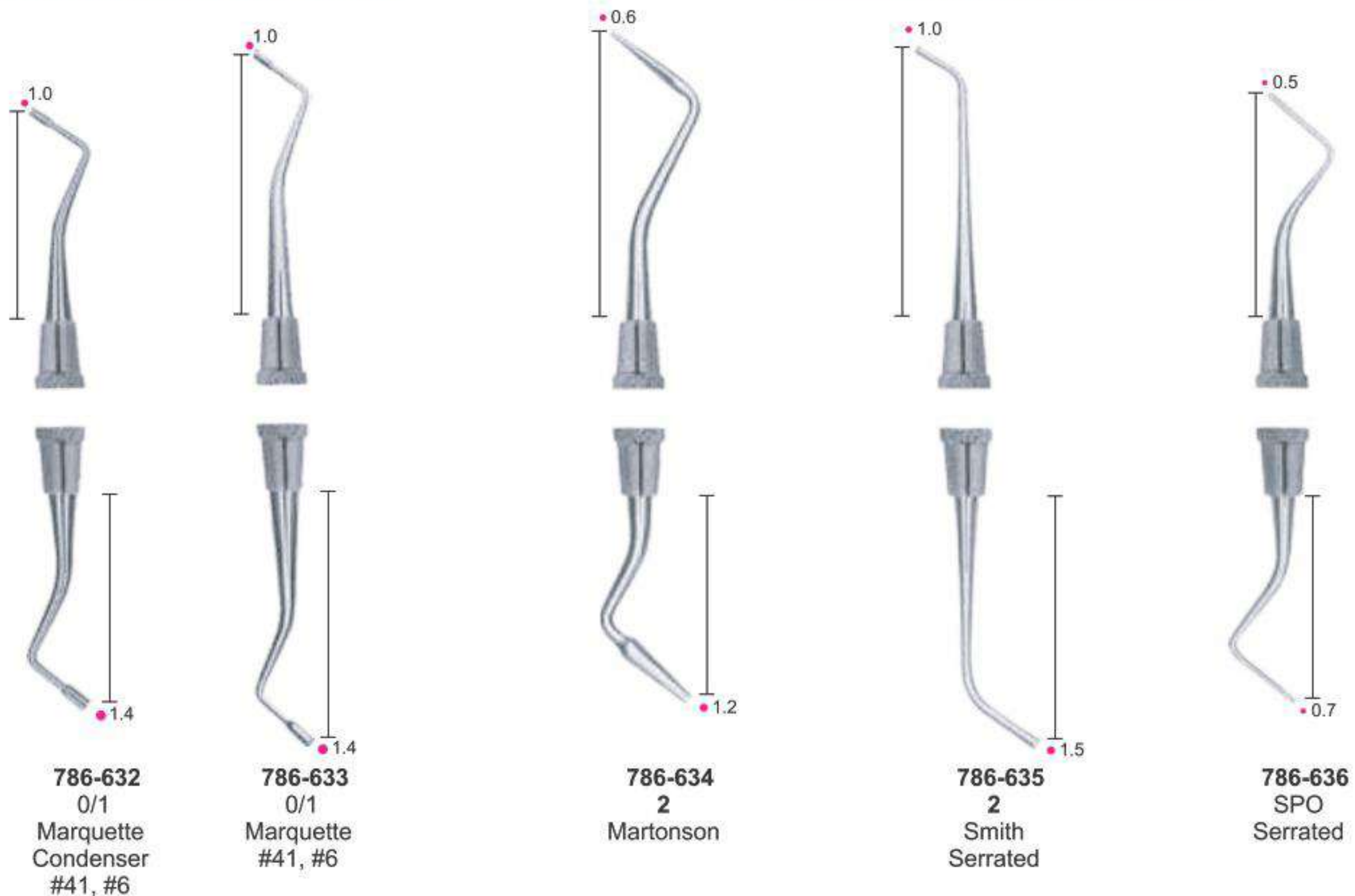

FILLING INSTRUMENTS

- Инструменты для реставрации
- Instruments pour plombage
- Füllungsinstrumente (mit Kontrawinkel)

- Інструменти для реставрації
- Instrumentos para obturaciones
- ملء الصكوك

PLUGGERS/CONDENSERS

RESTORATIVE INSTRUMENTS SOLID HANDLE 6MM, LENGTH 170MM

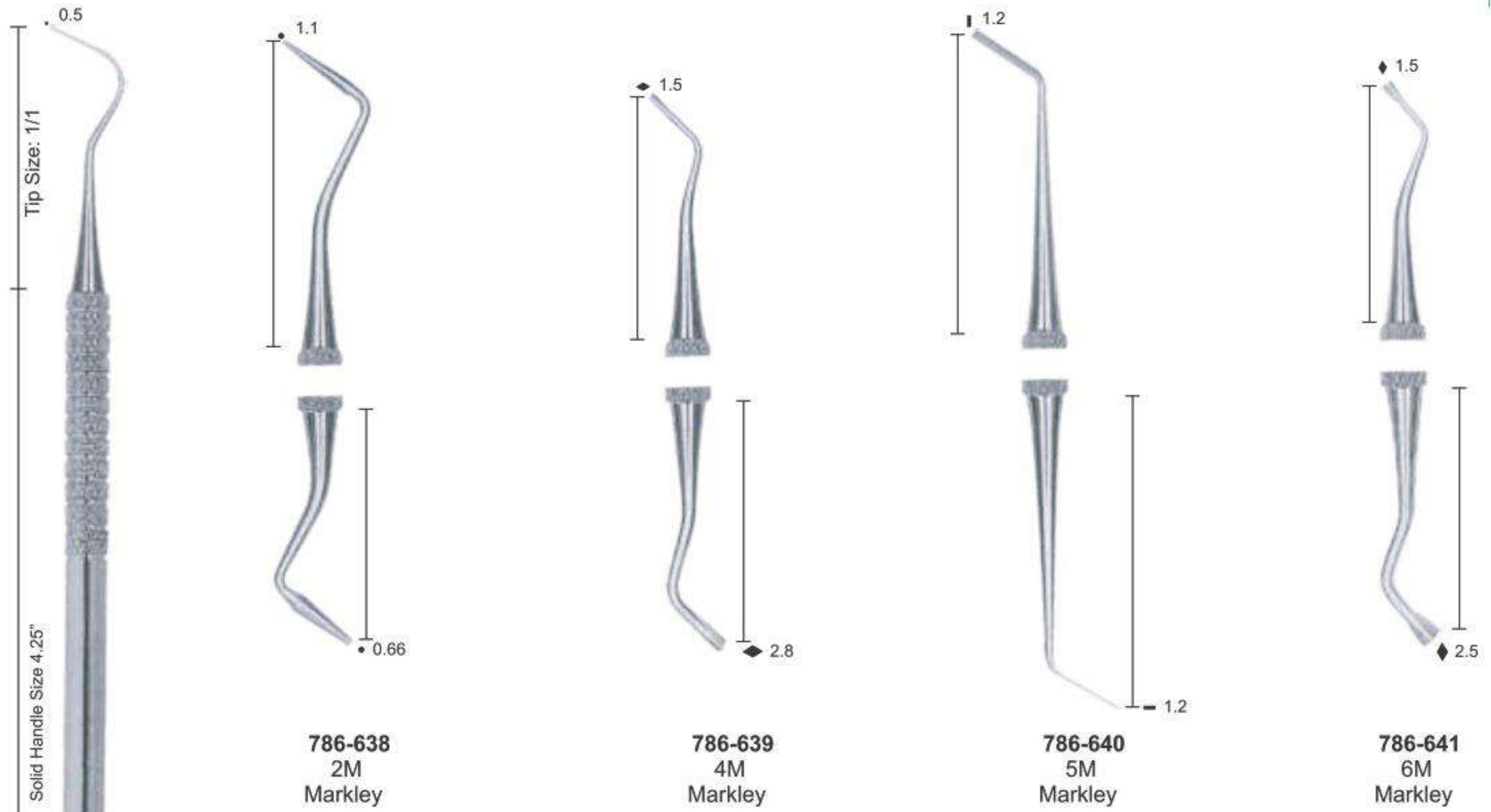

PLUGGERS/CONDENSERS

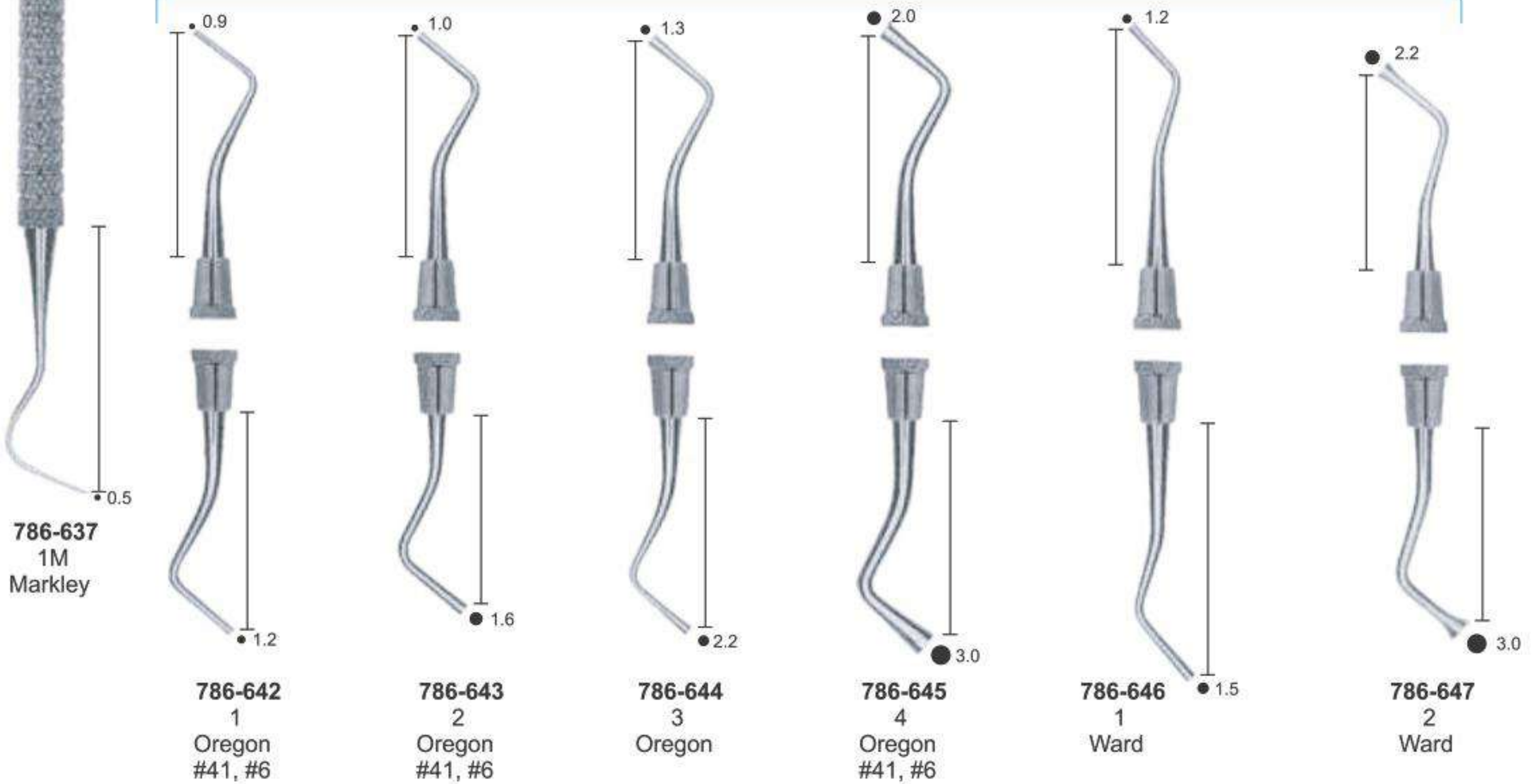

FILLING INSTRUMENTS

- Инструменты для реставрации
- Instruments pour plombage
- Füllungsinstrumente (mit Kontrawinkel)

- Інструменти для реставрації
- Instrumentos para obturaciones
- ملء الصكوك

RESTORATIVE INSTRUMENTS SOLID HANDLE 6MM, LENGTH 170MM

TANNER FILLING INSTRUMENTS

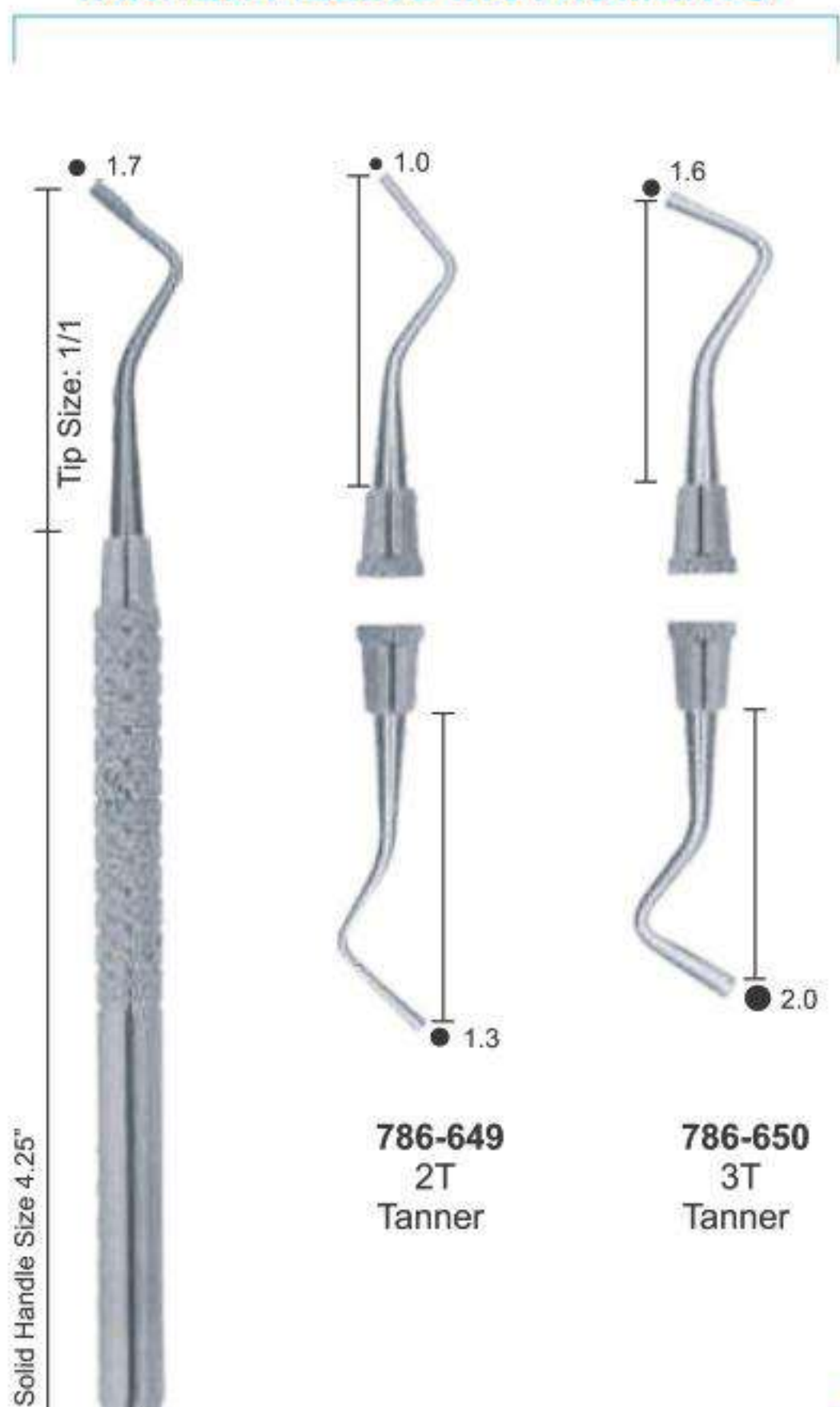

Solid Handle Size 4.25"

Tip Size: 1/1



786-649
2T
Tanner



786-650
3T
Tanner



786-651
9/10
Back Action



786-652
11/12
Back Action



786-653
153
English Pattern
Serrated



786-654
153
English Pattern
Serrated



1.3



2.0



1.6



2.5



2.4

BACK ACTION FILLING INSTRUMENTS

BURNISHERS

BALL



786-648
1T
Tanner



786-655
18
#41, #6



786-656
26/27S
#41, #6



786-657
27/29
#41, #6, #7, #8



786-658
2



786-659
18
Double End



786-660
21
#41, #6



786-661
21B
#41, #6, #8



786-662
2
Ladmore



2.3



1.6



1.3



3.1



1.5



1.7



2.7



1.3

BEAVERTAIL

ACORN

LADMORE

FILLING INSTRUMENTS

- Инструменты для реставрации
- Instruments pour plomage
- Füllungsinstrumente (mit Kontrawinkel)

- Инструменти для реставрації
- Instrumentos para obturaciones
- ملء الصكوك

RESTORATIVE INSTRUMENTS SOLID HANDLE 6MM, LENGTH 170MM

BURNISHERS

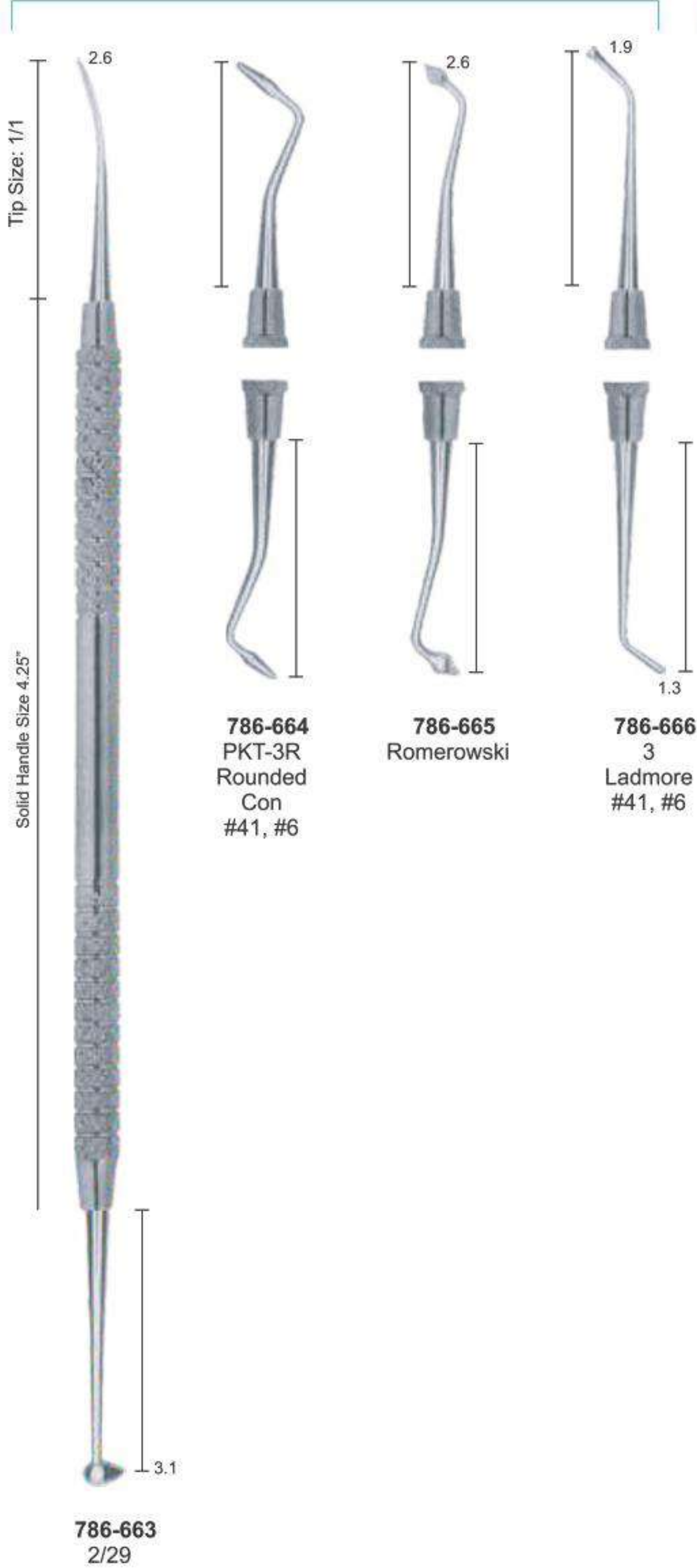

PERIODONTAL FILES

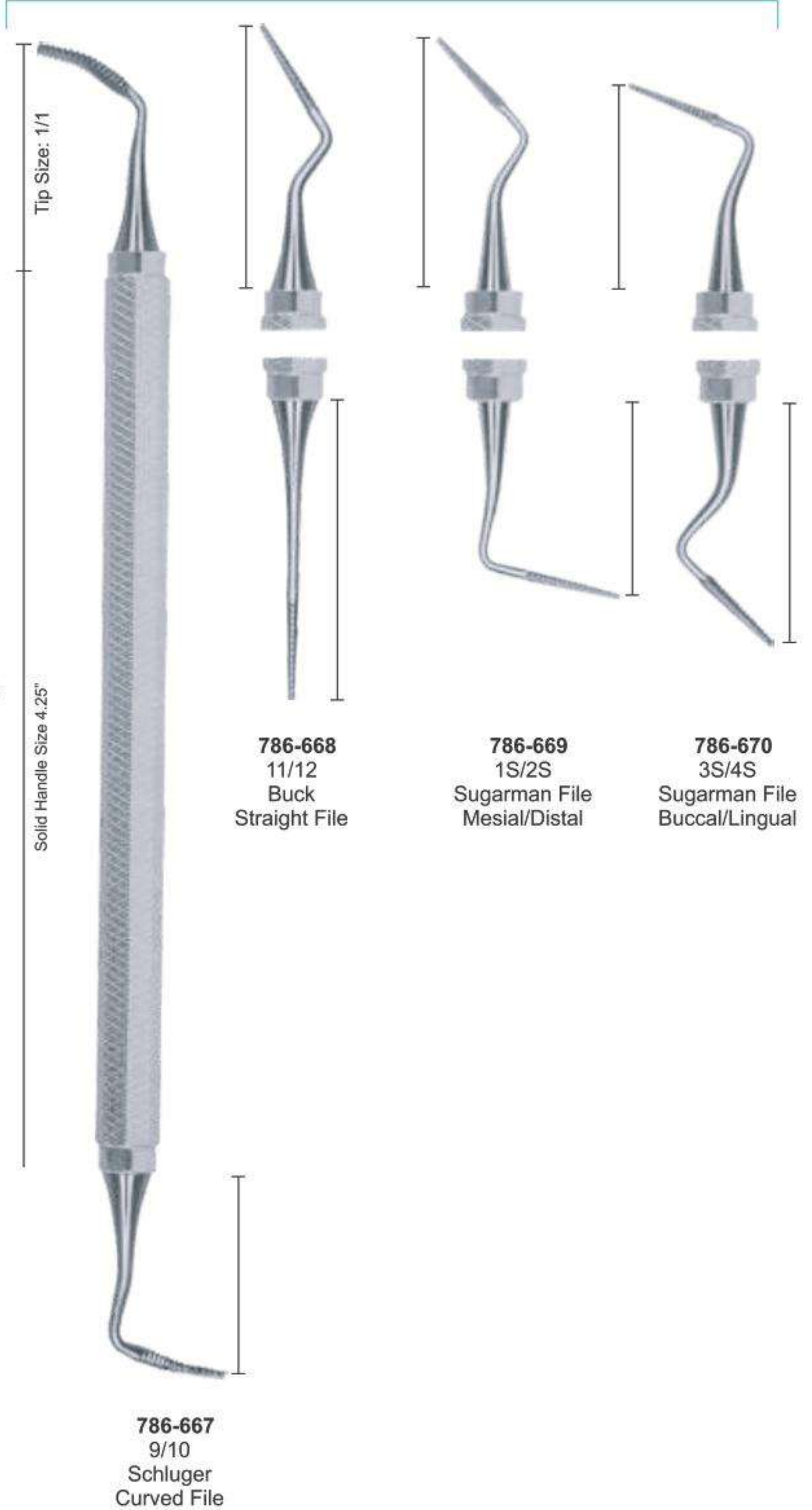

FILLING INSTRUMENTS

- Инструменты для реставрации
- Instruments pour plombage
- Füllungsinstrumente (mit Kontrawinkel)

- Інструменти для реставрації
- Instrumentos para obturaciones
- ملء الصكوك

COMPOSITE/PLASTIC FILLING INSTRUMENTS SOLID HANDLE 6MM, LENGTH 170MM

BURNISHER FILLING INSTRUMENTS

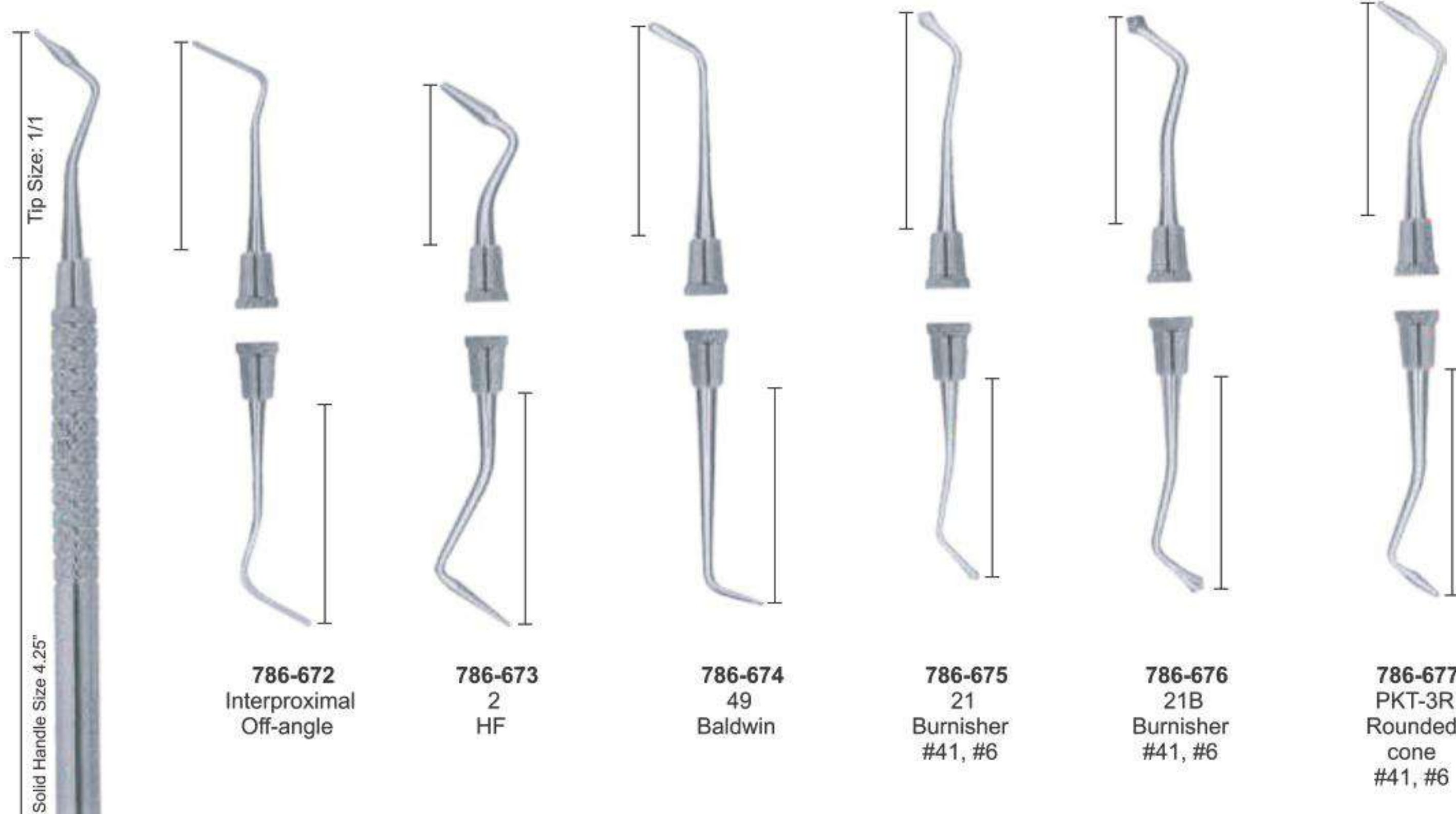

786-672
Interproximal
Off-angle

786-673
2
HF

786-674
49
Baldwin

786-675
21
Burnisher
#41, #6

786-676
21B
Burnisher
#41, #6

786-677
PKT-3R
Rounded
cone
#41, #6

UNIVERSAL FILLING INSTRUMENTS

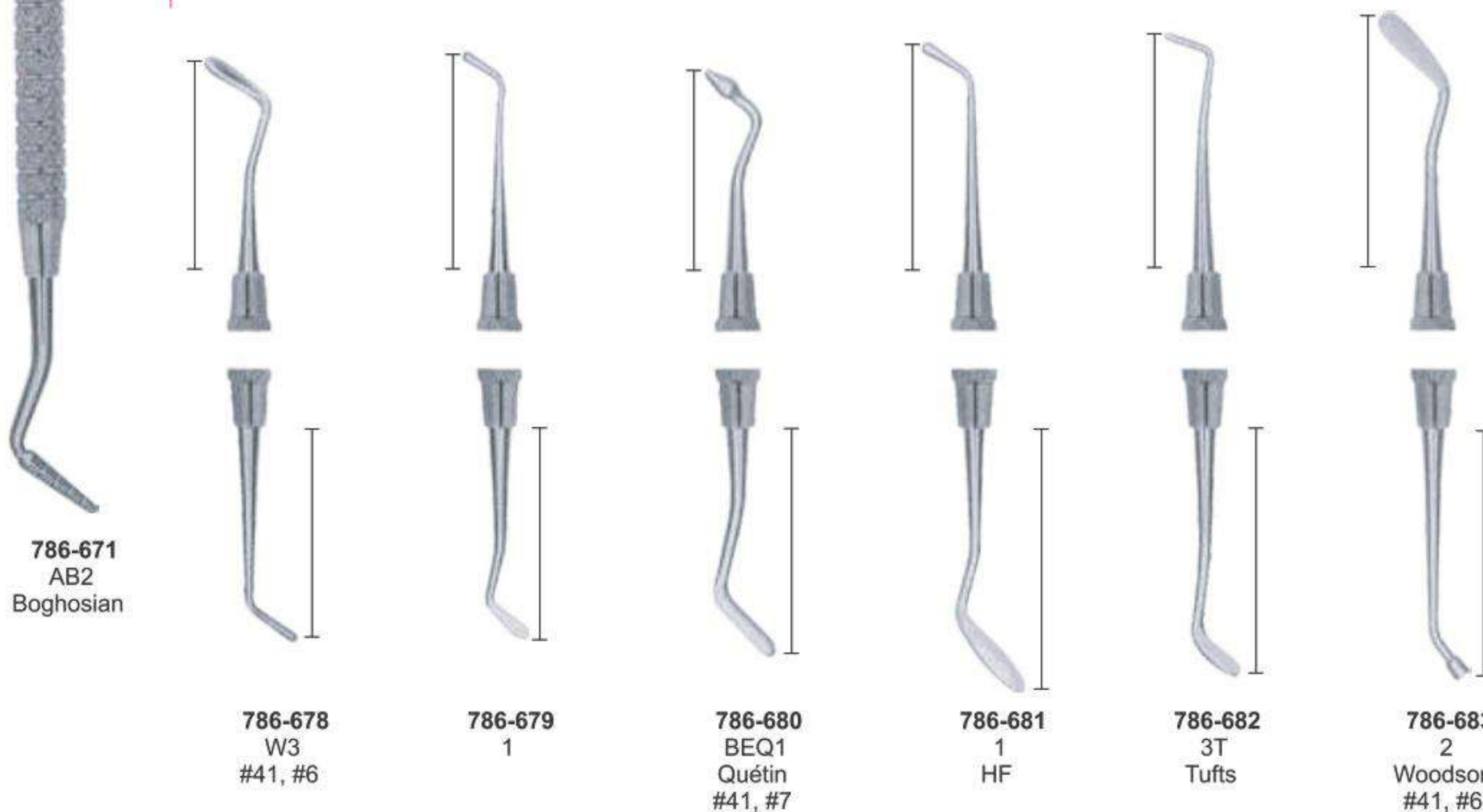

786-671
AB2
Boghosian

786-678
W3
#41, #6

786-679
1

786-680
BEQ1
Quétin
#41, #7

786-681
1
HF

786-682
3T
Tufts

786-683
2
Woodson
#41, #6

FILLING INSTRUMENTS

- Инструменты для реставрации
- Instruments pour plombage
- Füllungsinstrumente (mit Kontrawinkel)

- Інструменти для реставрації
- Instrumentos para obturaciones
- ملء الصكوك

FILLING INSTRUMENTS SOLID HANDLE 6MM, LENGTH 170MM



AMALGAM CARVERS

■ Инструменты для реставрации
 ■ Instruments pour amalgame
 ■ Amalgampistolen

■ Инструменти для реставрації
 ■ Instrumentos para amalgama
 ■ تطيع الملعغم

AMALGAM INSTRUMENTS SOLID HANDLE 6MM, LENGTH 170MM

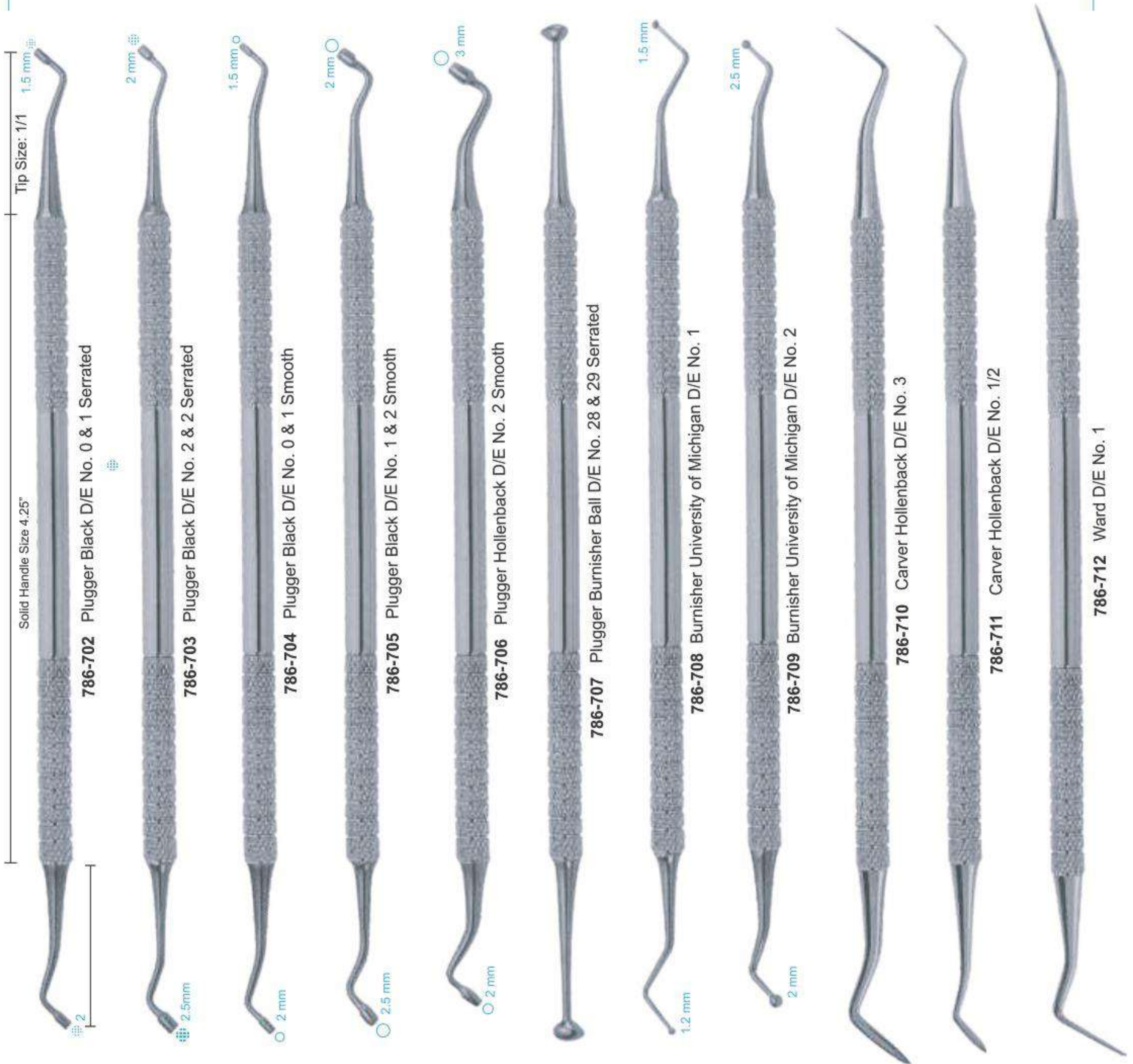

AMALGAM CARVERS

■ Инструменты для реставрации
 ■ Instruments pour amalgame
 ■ Amalgampistolen

■ Инструменты для реставрації
 ■ Instrumentos para amalgama
 ■ تتطيع الملعغم

AMALGAM INSTRUMENTS SOLID HANDLE 6MM, LENGTH 170MM

Excavators Instruments Set of 11 Pieces

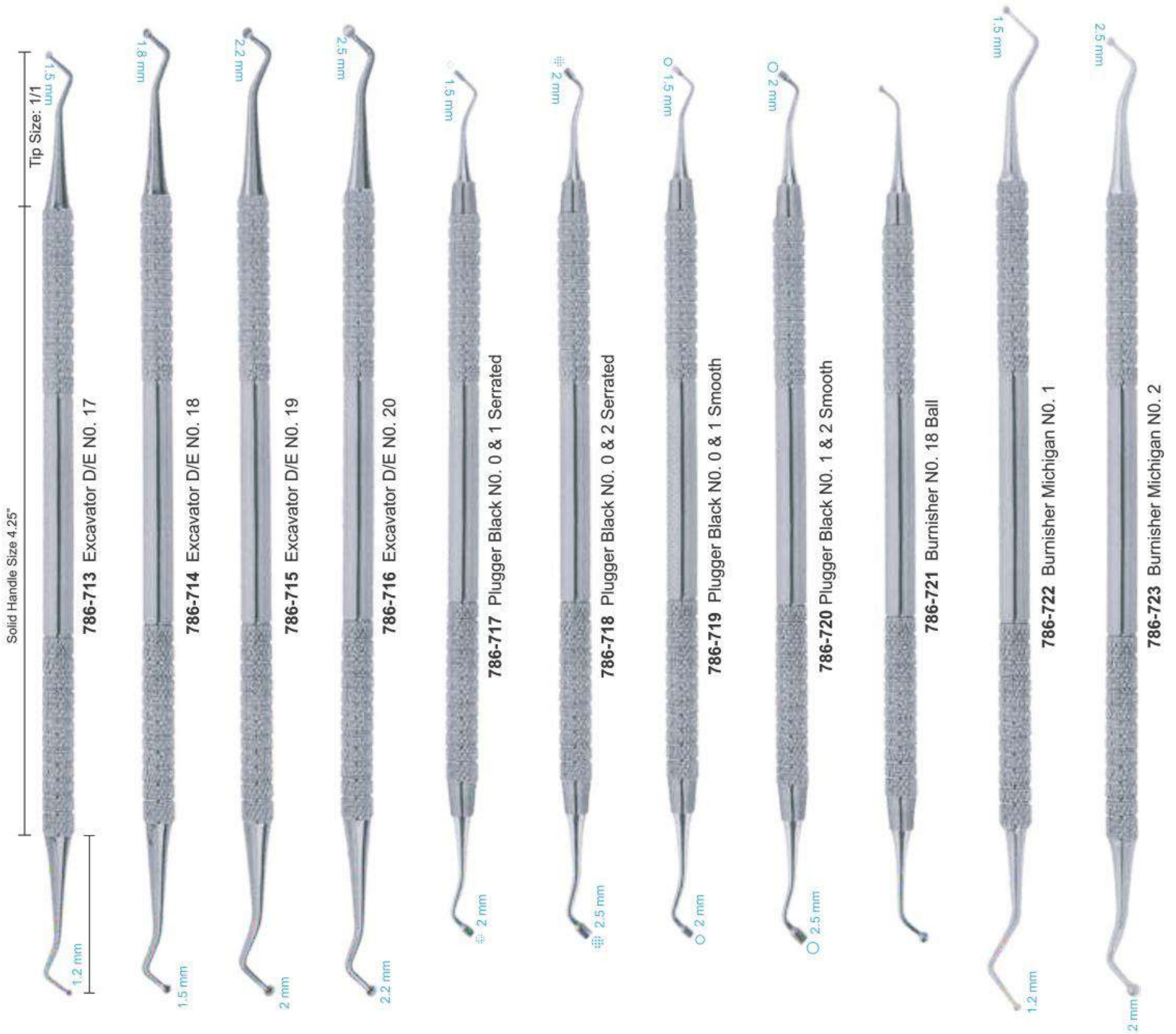

786-713 Excavator D/E NO. 17

PERIODONTAL INSTRUMENTS

■ Инструменты пародонтологические
 ■ Instruments pour la parodontologie
 ■ Instrumente für die Parodontologie

■ Інструменти пародонтологічні
 ■ Instrumentos para periodoncia
 ■ الصكوك اللثة

SICKLE SCALERS INSTRUMENTS SOLID HANDLE 6MM, LENGTH 170MM

SICKLE SCALERS

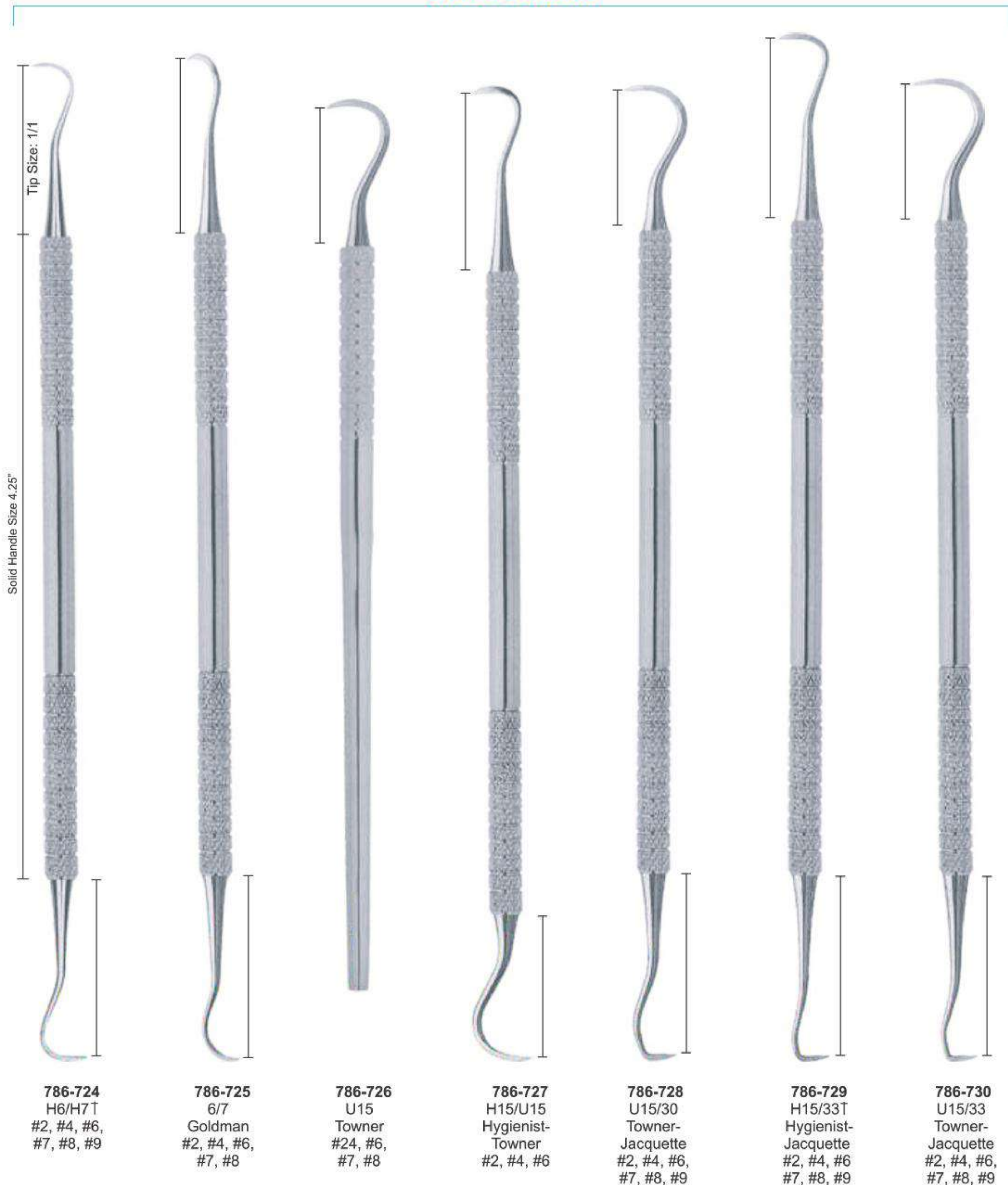

PERIODONTAL INSTRUMENTS

■ Инструменты пародонтологические
 ■ Instruments pour la parodontologie
 ■ Instrumente für die parodontologie

■ Інструменти пародонтологічні
 ■ Instrumentos para periodoncia
 ■ الصكوك اللثة

PERIODONTAL INSTRUMENTS SOLID HANDLE 6MM, LENGTH 170MM

JACQUETTE SCALERS

CRANE KAPLAN



PERIODONTAL INSTRUMENTS

■ Инструменты пародонтологические
 ■ Instruments pour la parodontologie
 ■ Instrumente für die parodontologie

■ Інструменти пародонтологічні
 ■ Instrumentos para periodoncia
 ■ الصكوك اللثة

PERIODONTAL INSTRUMENTS SOLID HANDLE 6MM, LENGTH 170MM

SCALER/CURETTE SETS

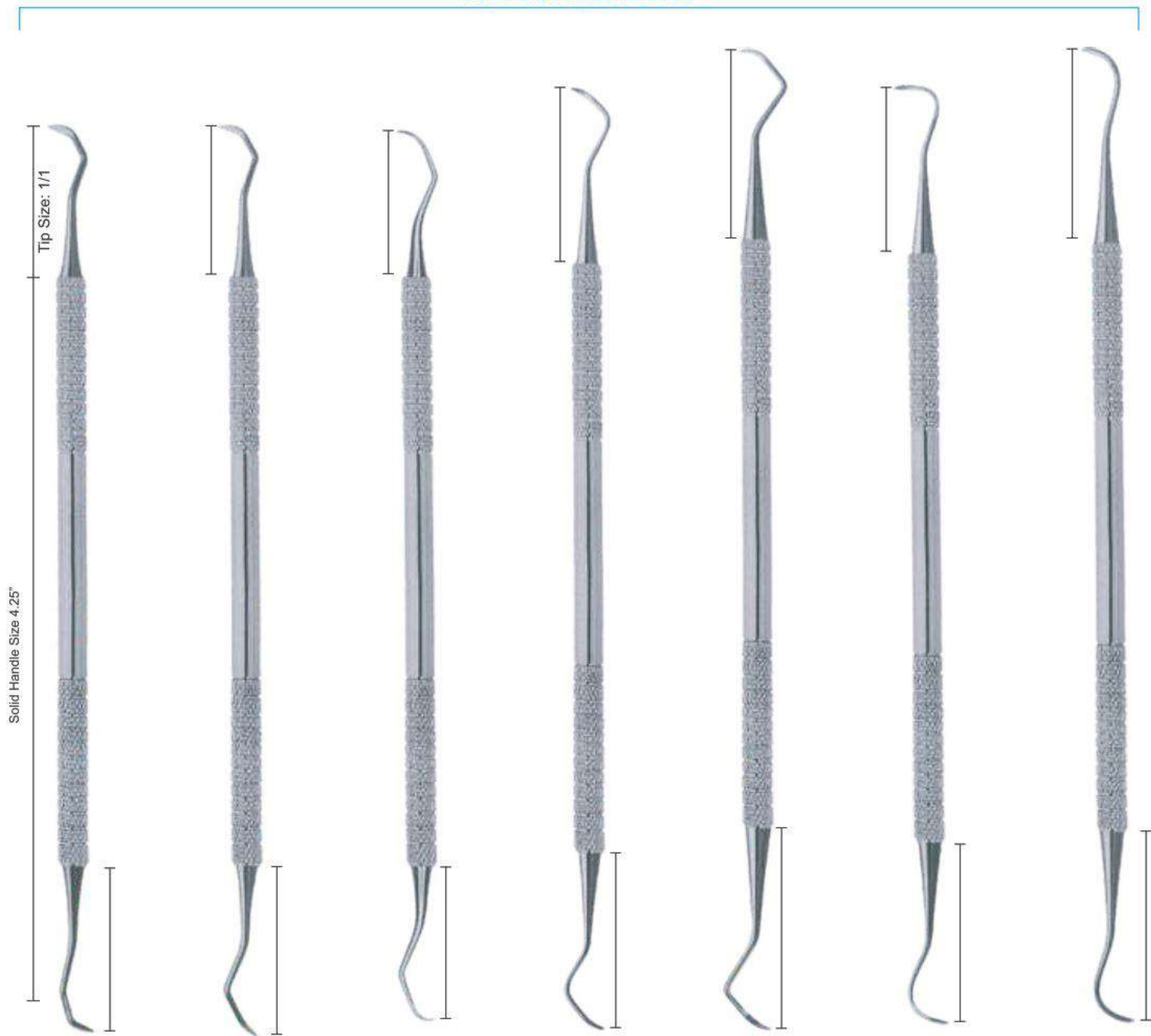

786-737
 11/12
 Scaler
 #2, #6,
 #7, #8,

786-738
 11A/12A
 Scaler
 #2, #4, #6

786-739
 11/12S
 Modief
 McCall
 #4, #6

786-740
 13S/14S
 Pointed
 Curette
 #2, #4, #6
 #7, #8, #9

786-741
 MTC 13/14
 Pointed
 Curette
 #4, #6

786-742
 17S/18S
 Curette
 #2, #4, #6
 #7, #8, #9

786-743
 19/20
 Curette
 #2

CURETTES

■ Кюрети
■ Curetas
■ Küretten

■ Кюрети
■ Curette
■ کرتس

SCALER/CURETTE SETS

GOLDMAN-FOX SET

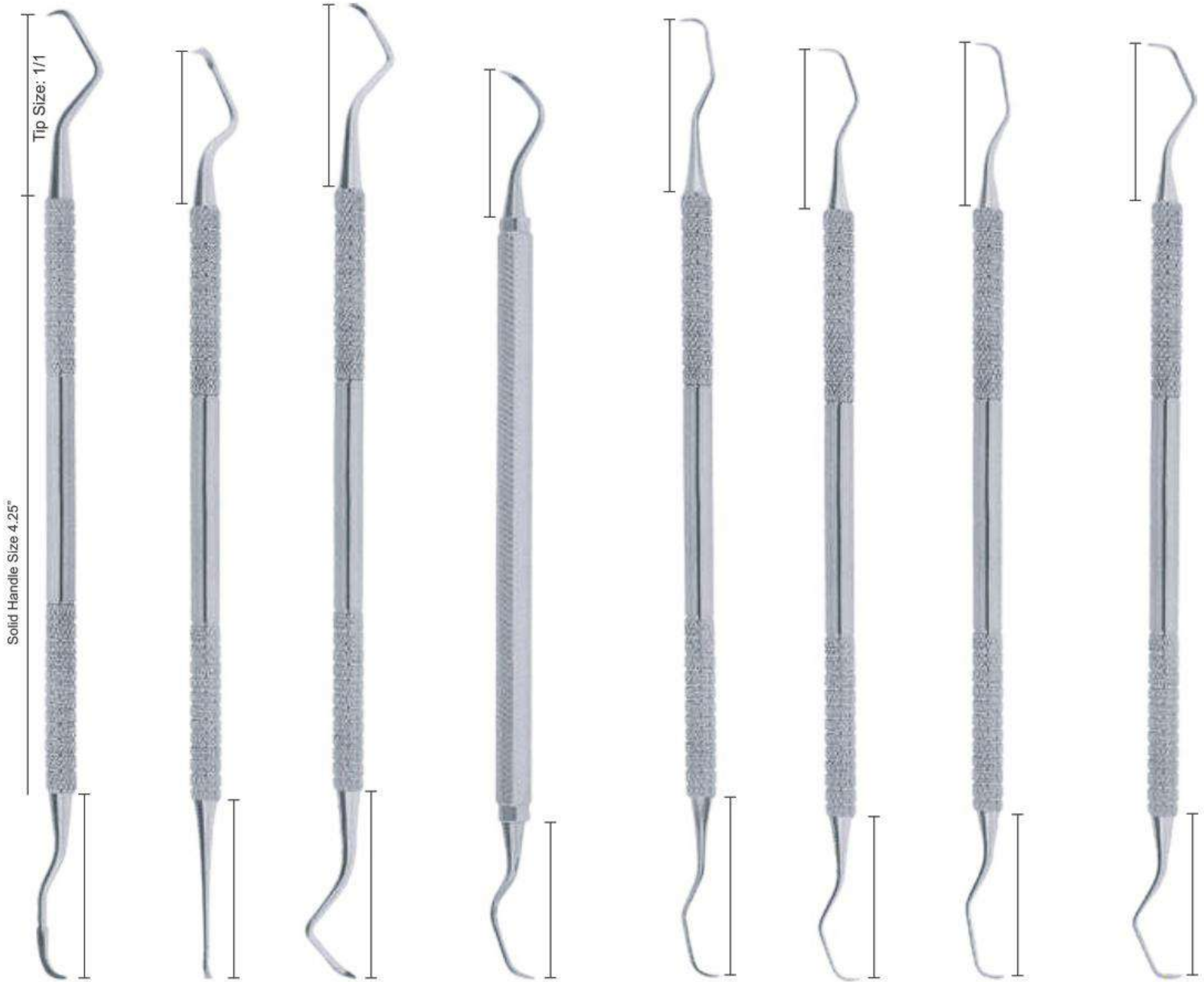

786-744
103/106
#4, #6

786-744A
104/106
Hoe/Chisel
#4, #6,

786-745
107/108
#2, #4, #6
#7, #8

786-746
107/108S
Modied
#2, #4

786-747
1/2
(shown)
#2, #4, #6
#7, #8, #9

786-749
3/4T
(shown)
#2, #4, #6
#7, #8, #9

786-751
5/6T
(shown)
#2, #4, #6
#7, #8, #9

786-754
7/8T
(shown)
#2, #4, #6
#7, #8, #9

786-748
1/2
Rigid
#2, #4, #6
#7, #8, #9

786-750
3/4
Rigid
#2, #4, #6
#7, #8, #9

786-752
5/6
Rigid
#2, #4, #6
#7, #8, #9

786-753
5/6
Extra Rigid
#4, #6 #7
#8

786-755
7/8
Rigid
#2, #4, #6
#7, #8, #9

786-756
7/8
Extra Rigid
#2, #4, #6
#7, #8, #9

**SCALER/CURETTE SETS INSTRUMENTS
SOLID HANDLE 6MM, LENGTH 170MM**

CURETTES

■ Кюрети
■ Curetas
■ Küretten

■ Кюрети
■ Curette
■ کرتس

GRACEY CURETTE INSTRUMENTS SOLID HANDLE 6MM, LENGTH 170MM
GRACEY CURETTES

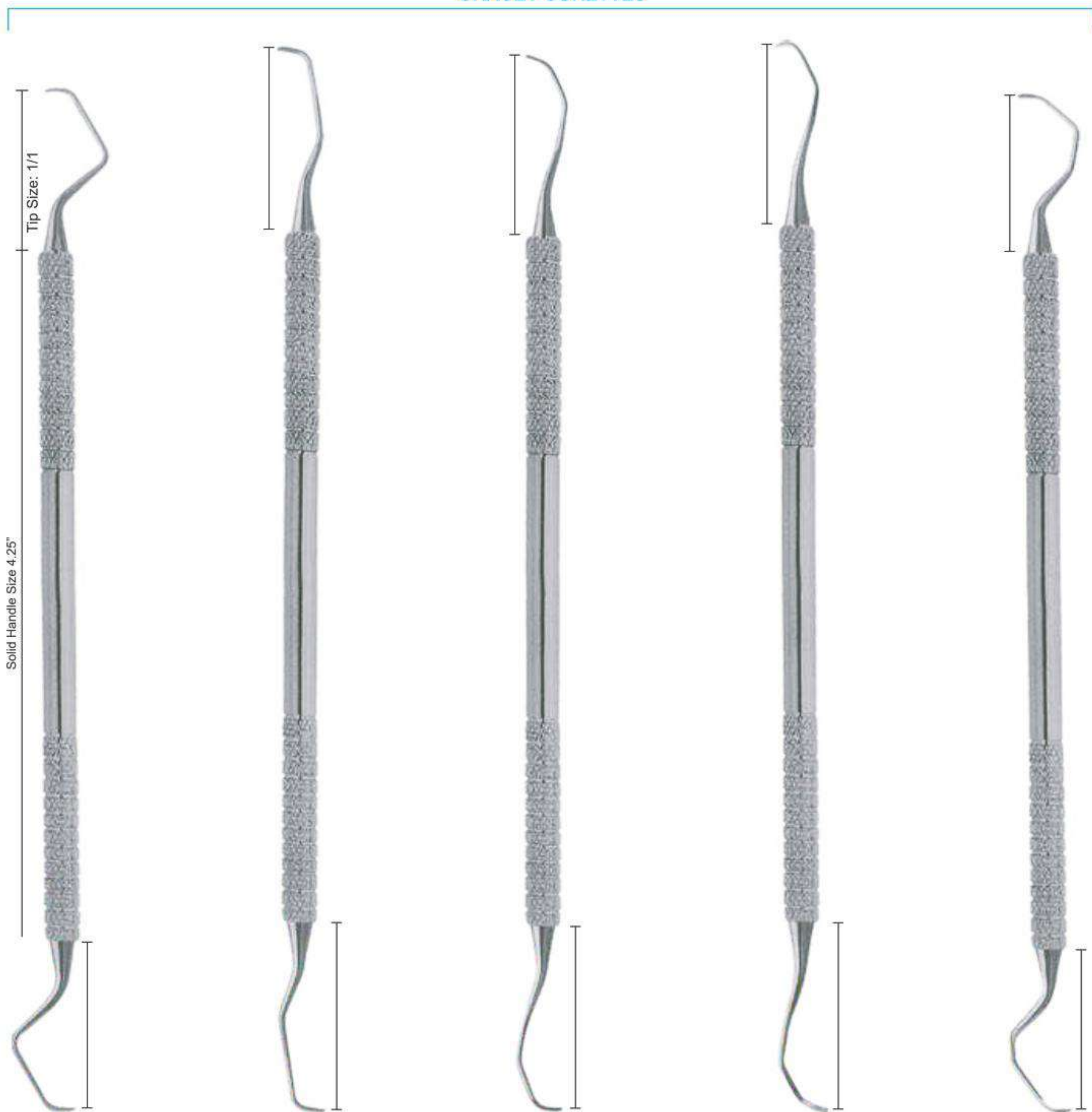

786-757
9/10T
(shown)
#2, #4, #6
#7, #8, #9

786-759
11/12T
(shown)
#2, #4, #6
#7, #8, #9

786-792
13/14T
(shown)
#2, #4, #6
#7, #8, #9

786-765
15/16T
(shown)
#2, #4, #6
#7, #8, #9

786-767
17/18
(shown)
#2, #4, #6
#7, #8, #9

786-758
9/10
Rigid
#2, #4, #6
#7, #8, #9

786-760
11/12
Rigid
#2, #4, #6
#7, #8, #9

786-761
11/12
Extra Rigid
#4, #6
#7, #8

786-793
13/14
Rigid
#2, #4, #6
#7, #8, #9

786-764
13/14
Extra Rigid
#4, #6
#7, #8

786-766
15/16
Rigid
#2, #4, #6
#7, #8, #9

786-768
17/18
Rigid
#2, #4, #6
#7, #8, #9

CURETTES

- Кюрети
- Curetas
- Küretten

- Кюрети
- Curette
- کرتس

CURETTE INSTRUMENTS
HOLLOW HANDLE 8.5MM, LENGTH 170MM

CURETTE INSTRUMENTS
SOLID HANDLE 6MM, LENGTH 170MM

CURETTE INSTRUMENTS
SOLID HANDLE 6MM, LENGTH 170MM

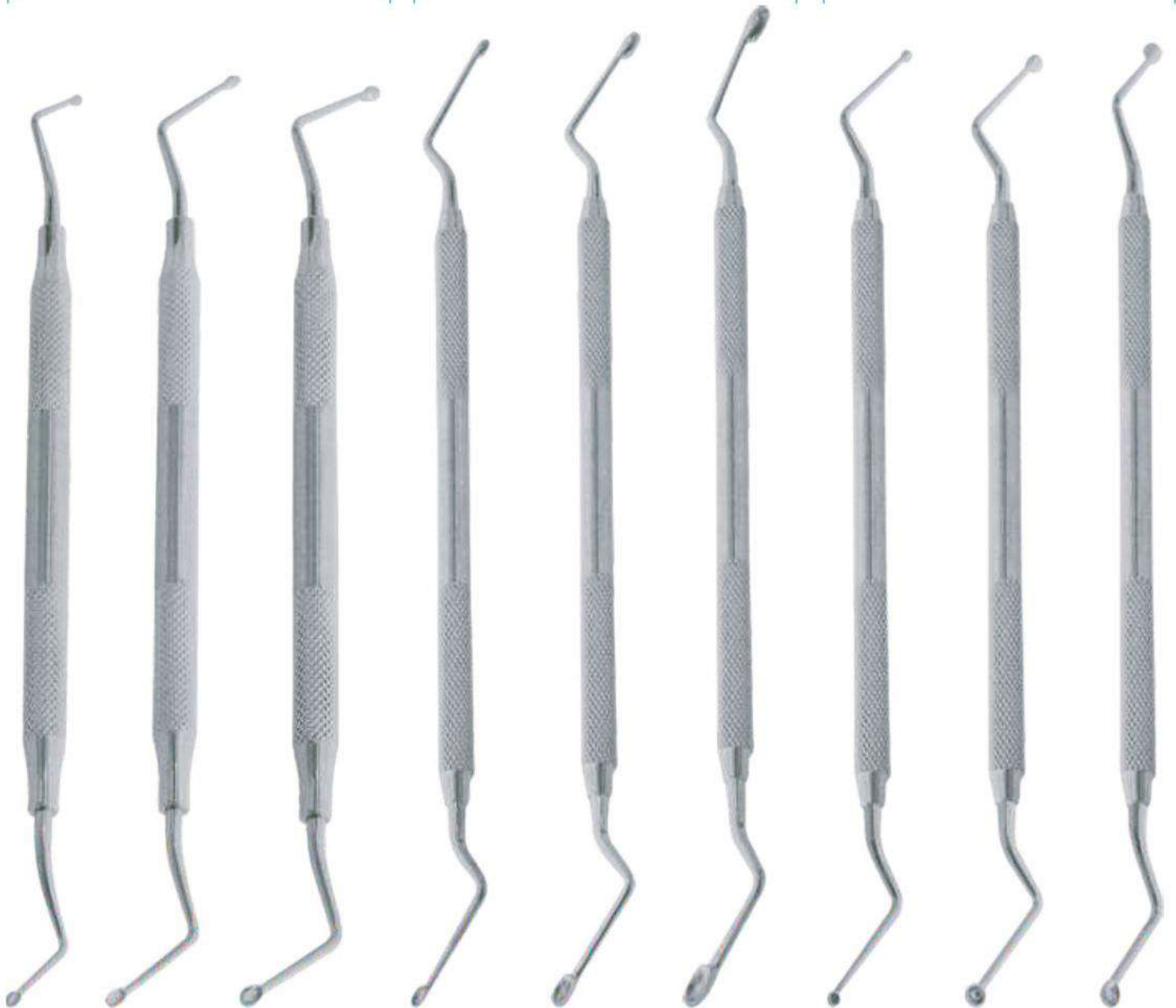

786-769
Hemingway
2mm, 2mm

786-770
Hemingway
3mm, 3mm

786-771
Hemingway
4mm, 4mm

786-772
Hemingway
2mm, 2mm

786-773
Hemingway
3mm, 3mm

786-774
Hemingway
4mm, 4mm

786-785
Hemingway
2mm, 2mm

786-776
Hemingway
3mm, 3mm

786-777
Hemingway
4mm, 4mm

EXCAVATORS

- Экскаваторы
- Excavateurs
- Excavatoren
- Экскаватори
- Excavadores
- حفارات

EXCAVATOR INSTRUMENTS SOLID HANDLE 6MM, LENGTH 170MM

SPOONS

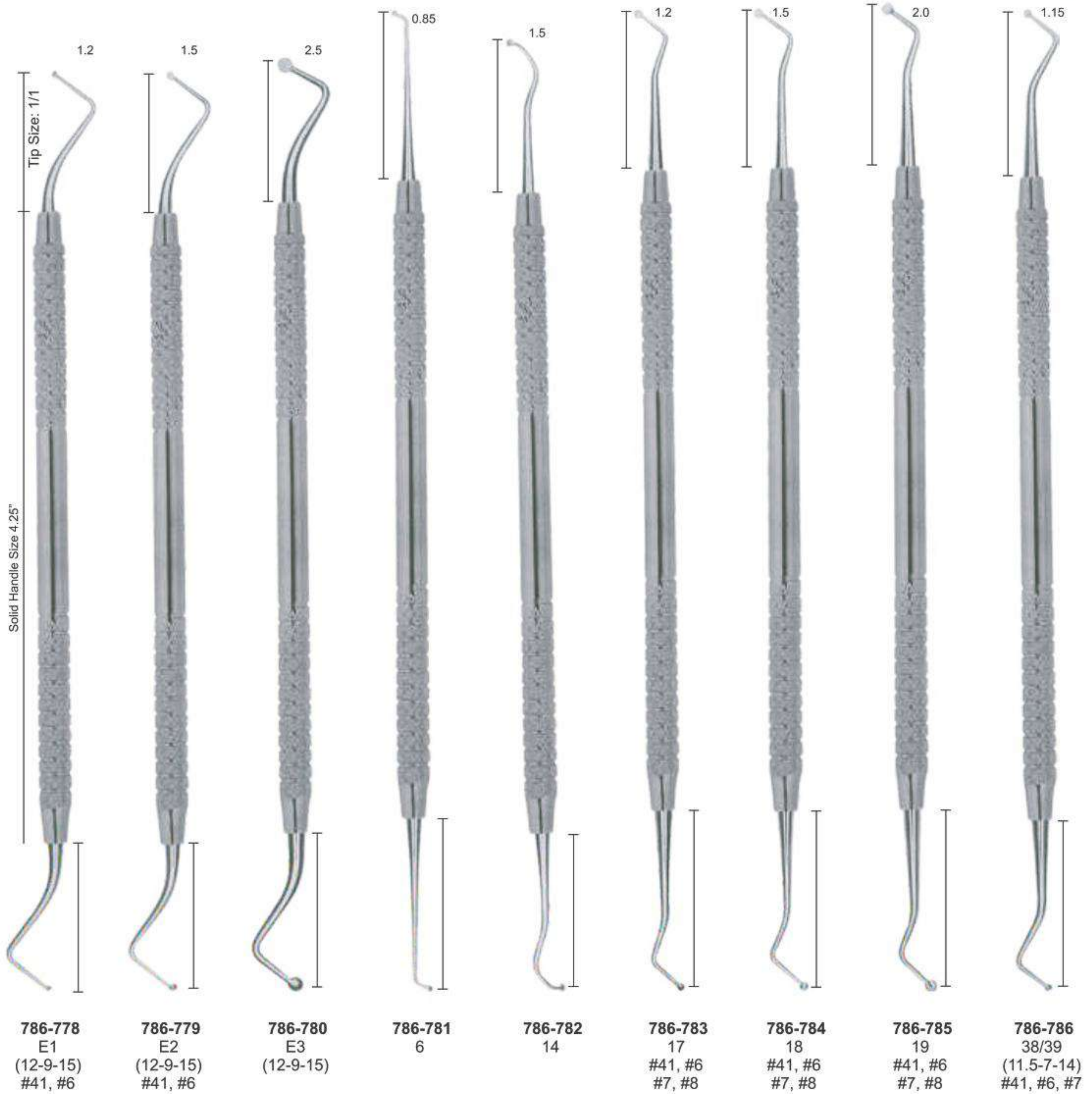

EXCAVATORS

■ Экскаваторы
■ Excavateurs
■ Excavatoren

■ Экскаватори
■ Excavadores
■ حفارات

OVAL SPOONS/DARBY-PERRY

EXCAVATORS INSTRUMENTS
SOLID HANDLE 6MM, LENGTH 170MM

EXCAVATORS

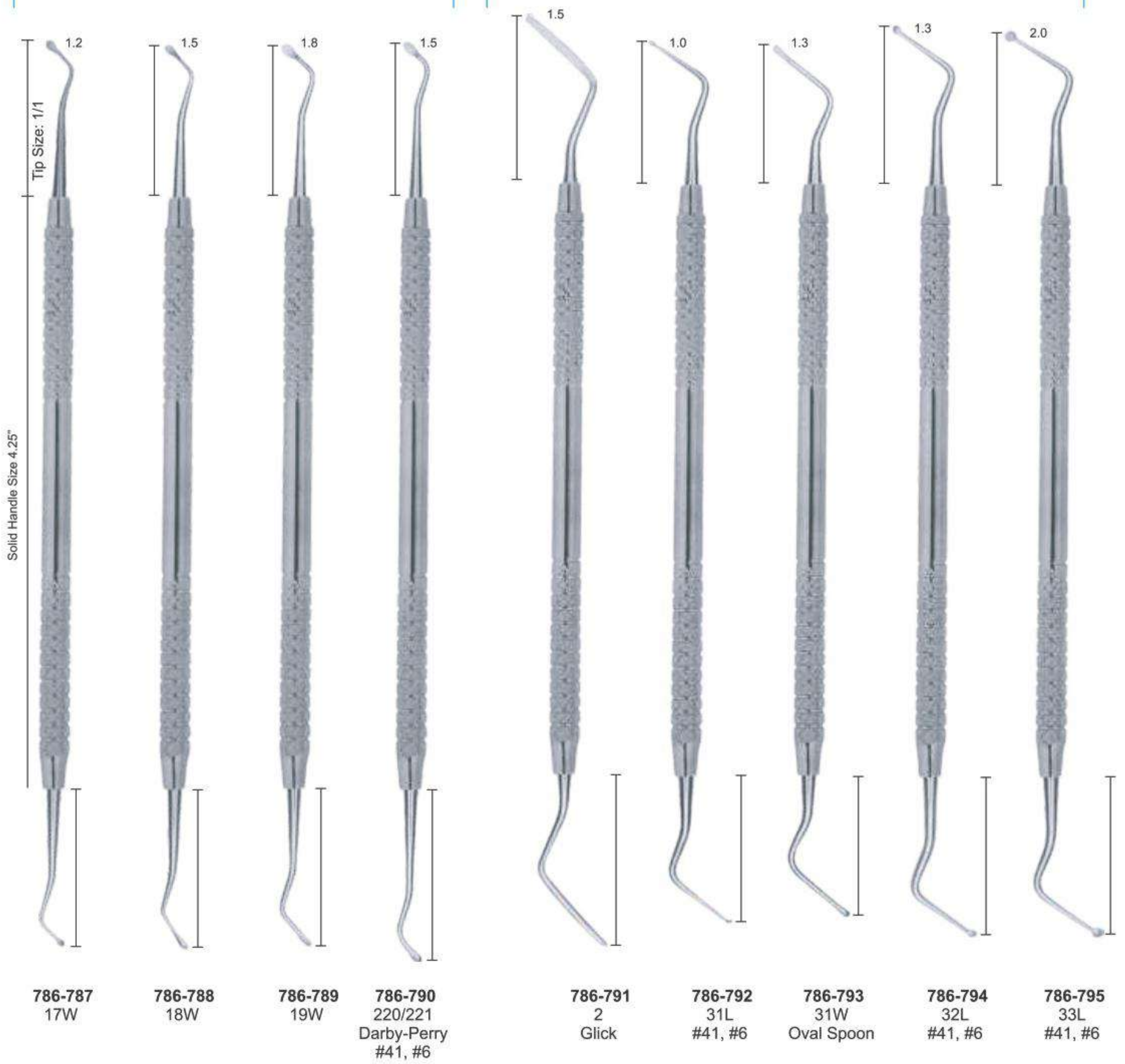

EXCAVATORS

■ Экскаваторы
■ Excavateurs
■ Excavatoren

■ Excavatori
■ Excavadores
■ حفارات

EXCAVATOR INSTRUMENTS SOLID HANDLE 6MM, LENGTH 170MM

BLADES



EXCAVATORS

■ Экскаваторы
■ Excavateurs
■ Excavatoren

■ Экскаватори
■ Excavadores
■ حفارات

EXCAVATORS INSTRUMENTS SOLID HANDLE 6MM, LENGTH 170MM

ENGLISH PATTERNS

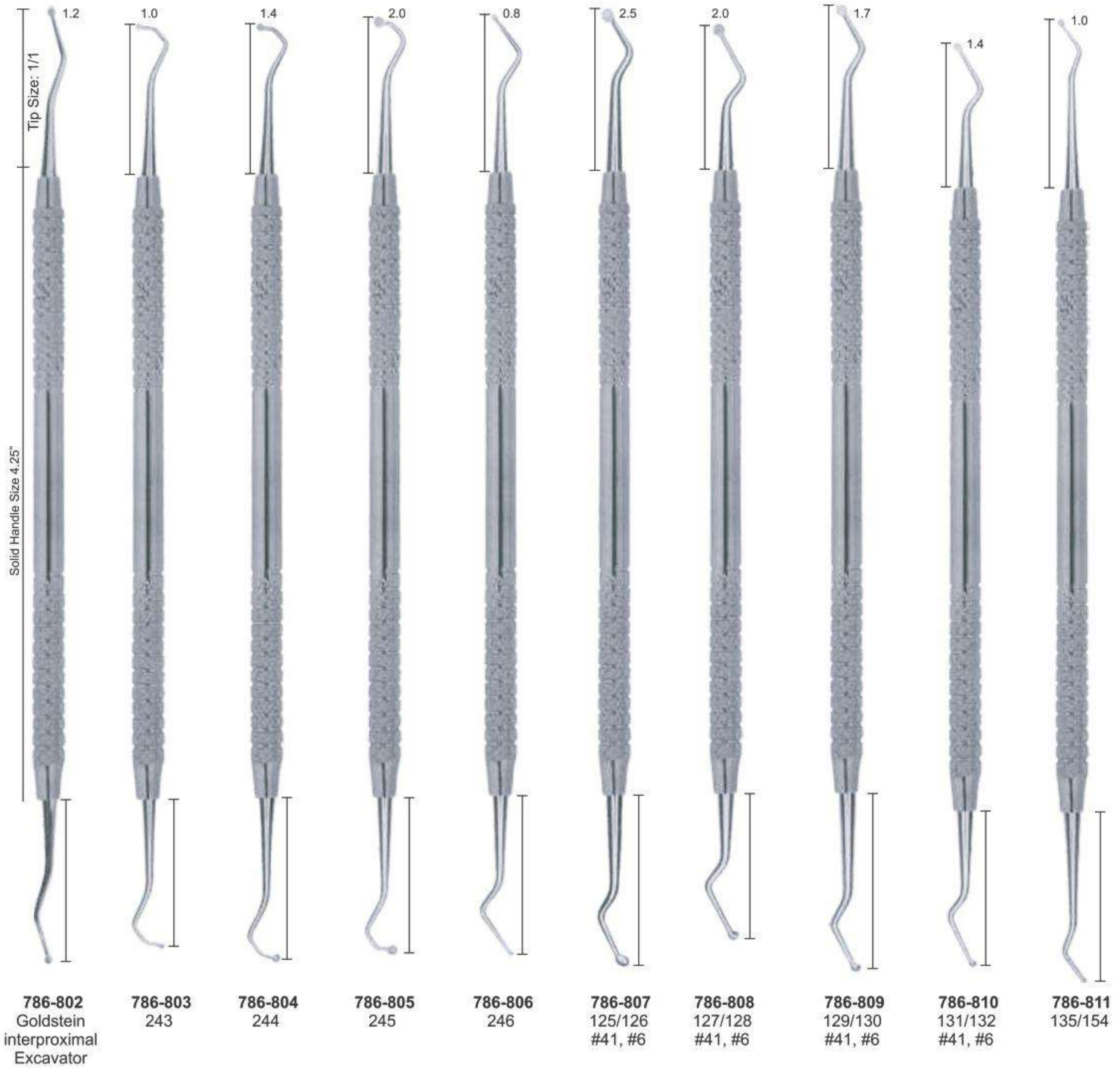

FILLING INSTRUMENTS

- Инструменты для реставрации
- Instruments pour plombage
- Füllungsinstrumente (mit Kontrawinkel)

- Інструменти для реставрації
- Instrumentos para obturaciones
- ملء الصكوك

HATCHETS

RESTORATIVE INSTRUMENTS SOLID HANDLE 6MM, LENGTH 170MM

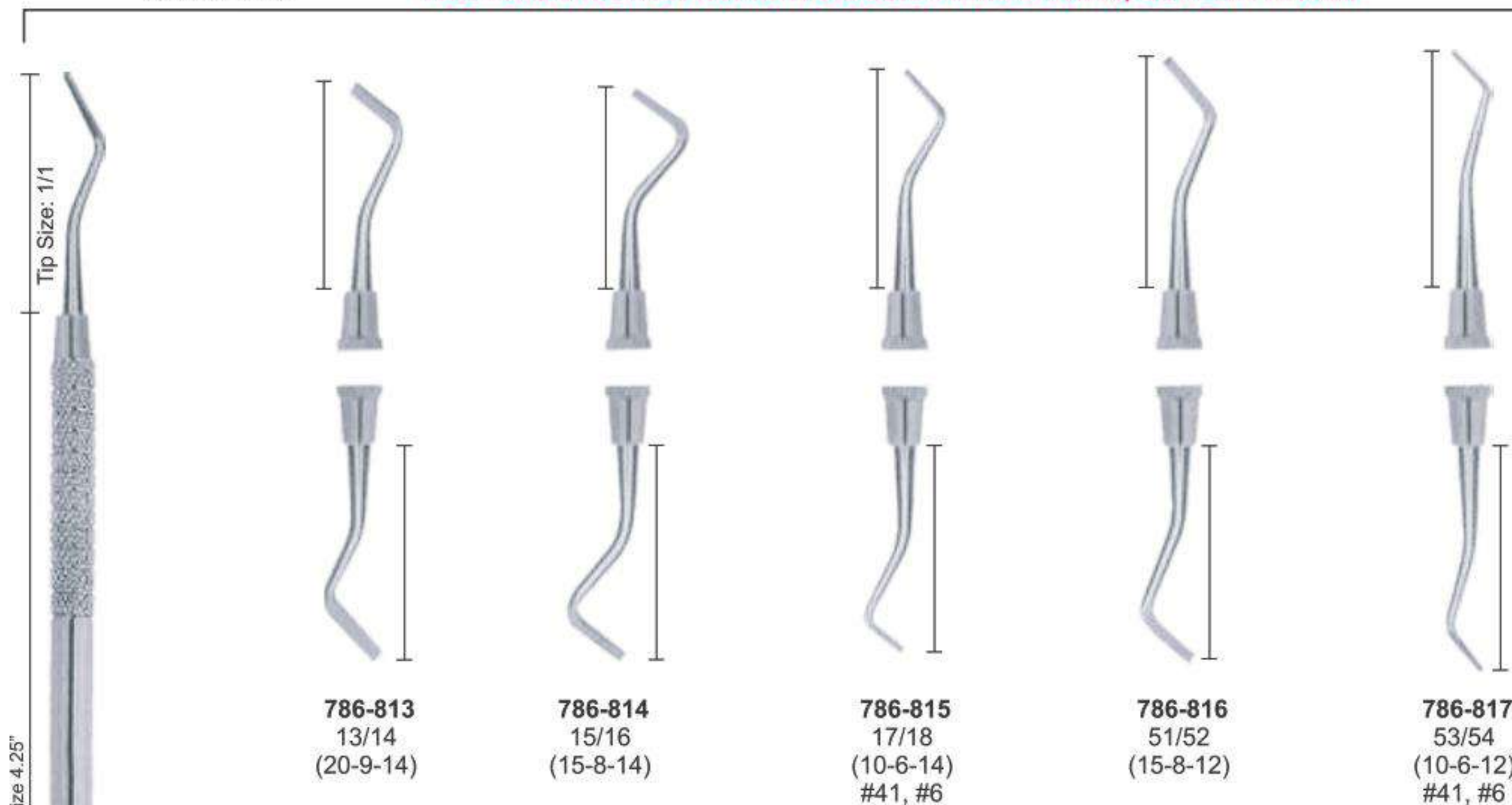

ANTERIOR



FILLING INSTRUMENTS

- Инструменты для реставрации
- Instruments pour plombage
- Füllungsinstrumente (mit Kontrawinkel)

- Інструменти для реставрації
- Instrumentos para obturaciones
- ملء الصكوك

CARVERS

RESTORATIVE INSTRUMENTS SOLID HANDLE 6MM, LENGTH 170MM

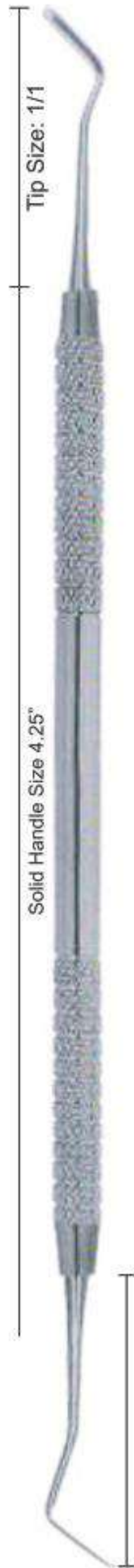

786-826
Inter-proximal
#41, #6, #7



786-827
Inter-proximal
Off-Angle



786-828
1/2-3
Hollenback
#41, #6,
#7, #8



786-829
3S
Hollenback
#41, #6, #7

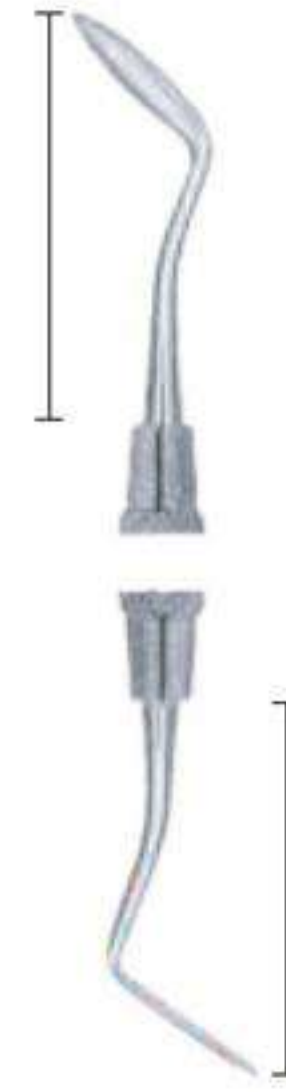

786-830
3
Hollenback



786-831
8
Wiland
Minn.IPC1
#41, #6, #7

TANNER

WALL

WARD

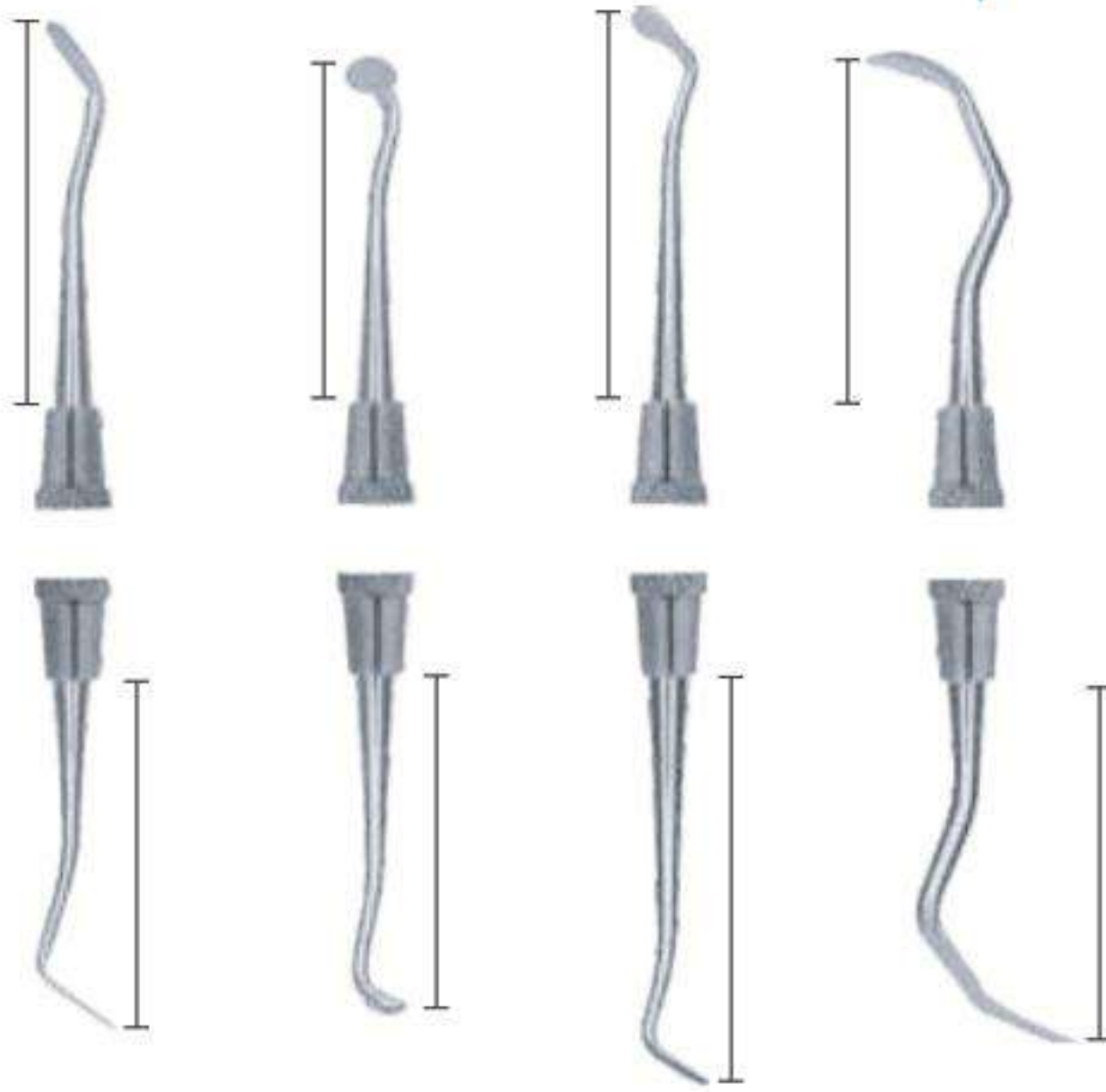

786-832
3
Tanner

786-833
4
Tanner

786-834
5
Tanner

786-835
6
Tanner

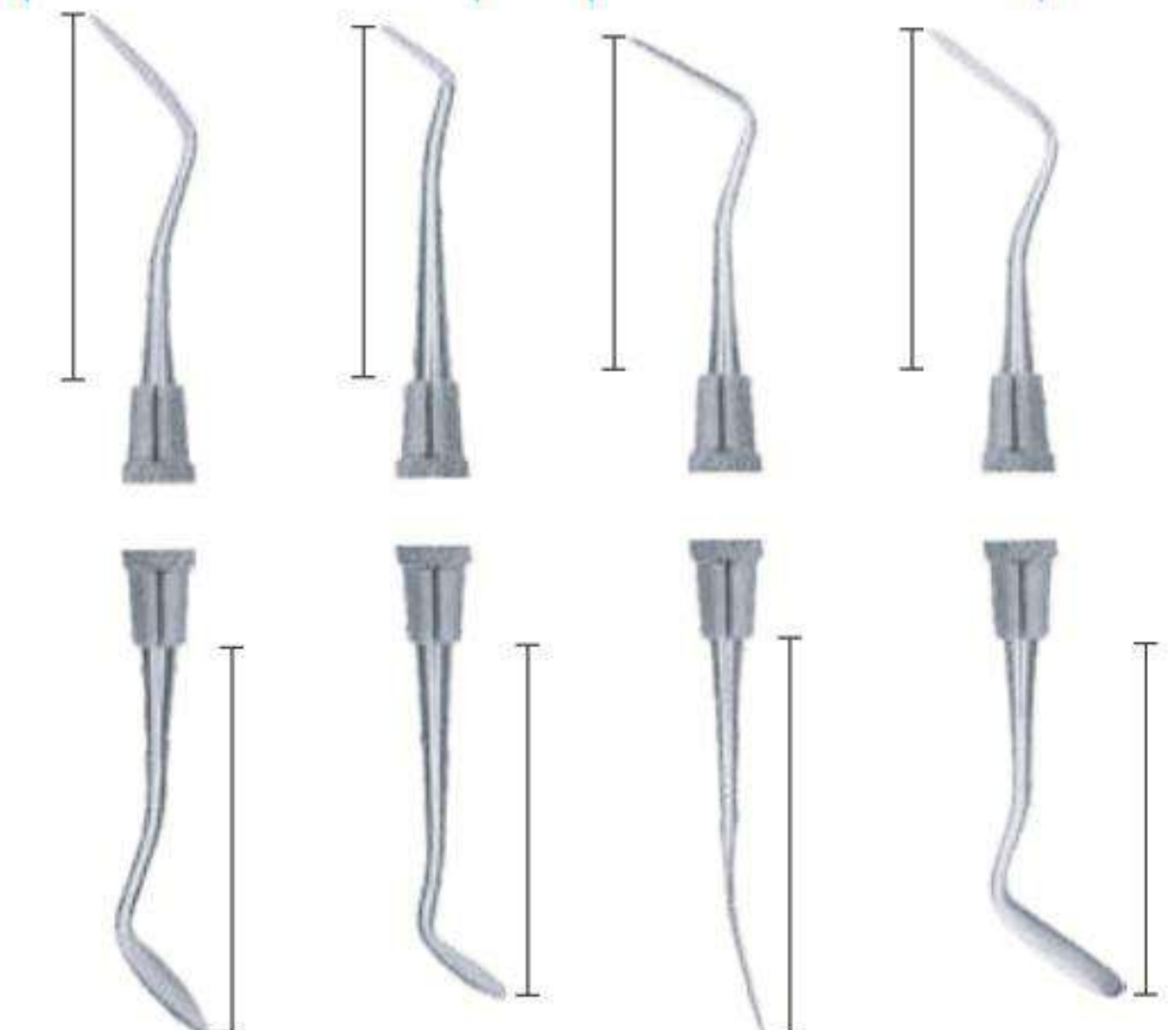

786-836
1
Wall

786-837
3
Wall

786-838
1
Ward

786-839
2
Ward

AMALGAM CARVERS

■ Инструменты для реставрации
 ■ Instruments pour amalgama
 ■ Amalgampistolen

■ Инструменты для реставрації
 ■ Instrumentos para amalgama
 ■ تقطيع الملمع

RESTORATIVE INSTRUMENTS

ANDREW

SOLID HANDLE 6MM, LENGTH 170MM

CLAPPISON/FRAHAM

HOLLENBACK

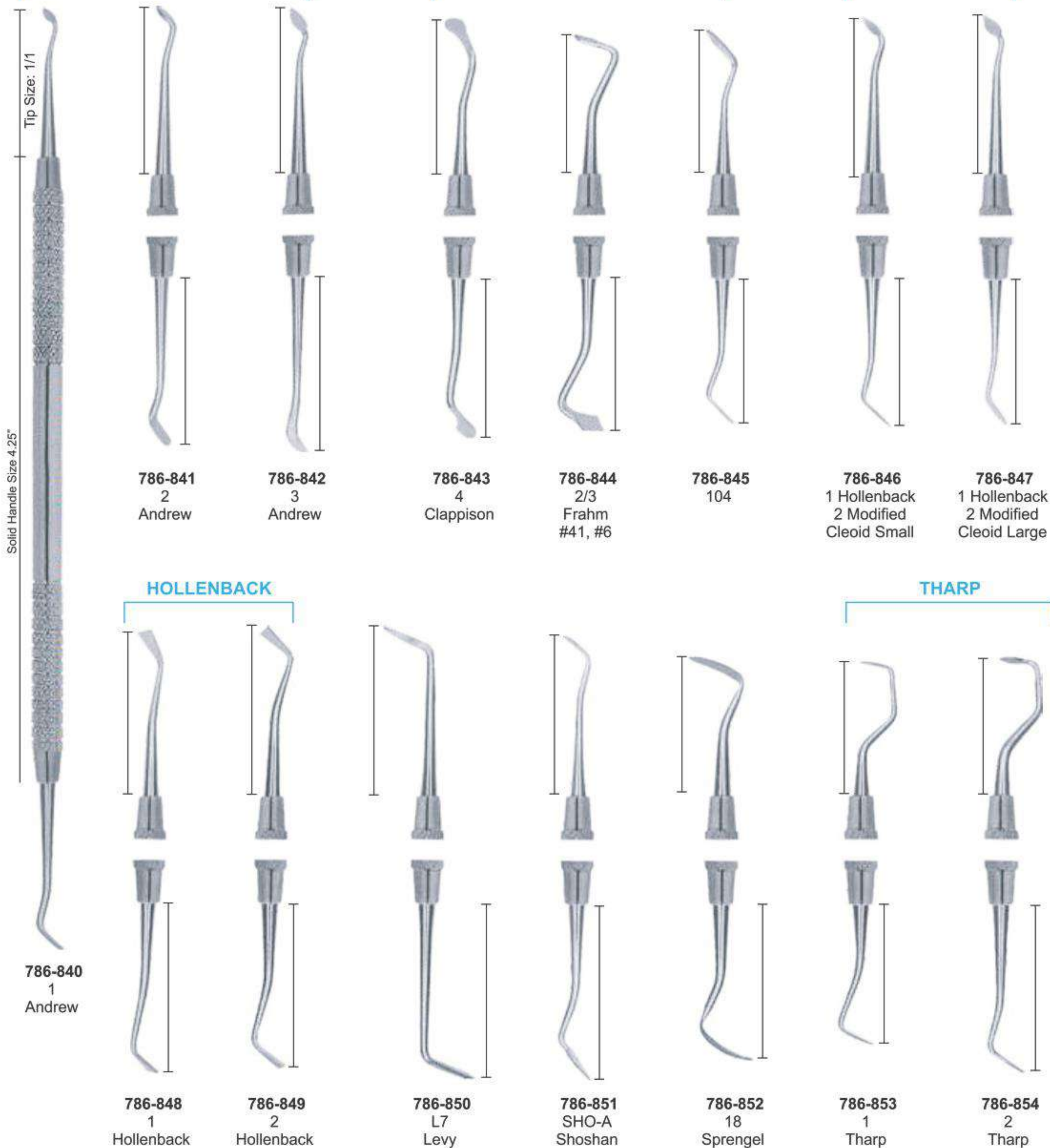

AMALGAM CARVERS

■ Инструменты для реставрации
 ■ Instruments pour amalgama
 ■ Amalgampistolen

■ Инструменти для реставрації
 ■ Instrumentos para amalgama
 ■ تقطيع الملغم

RESTORATIVE INSTRUMENTS SOLID HANDLE 6MM, LENGTH 170MM

CARVERS

Tip Size: 1/1

Solid Handle Size 4.25"

786-856
Discoid-Cleoid Carver

786-855
Anatomical Carver

AMALGAM FILES

786-857
31/32 Rhein

786-858
1/4 Wedelstaedt

786-859
2/5 Wedelstaedt

HOES
Forming Line Angle on Anterior Preparations

Solid Handle Size 4.25"

786-863
20 (14-6-8)

786-864
21 (10-4-8)

786-865
22 (10-4-14)

786-866
23 (6.5-2.5-9)

DISCOID CLEOIDS

786-860
1/2

786-861
4/5 #41, #6, #7

786-862
3/6 #41, #6, #7

786-867
89/92 #41, #6, #7

786-868
90B

786-869
89/92 W-A-C-D

FILLING INSTRUMENTS

- Инструменты для реставрации
- Instruments pour plombage
- Füllungsinstrumente (mit Kontrawinkel)

- Інструменти для реставрації
- Instrumentos para obturaciones
- ملء الصكوك

RESTORATIVE INSTRUMENTS SOLID HANDLE 6MM, LENGTH 170MM

MARGIN TRIMMERS



786-870
26
(13-95-8-14)
Distal

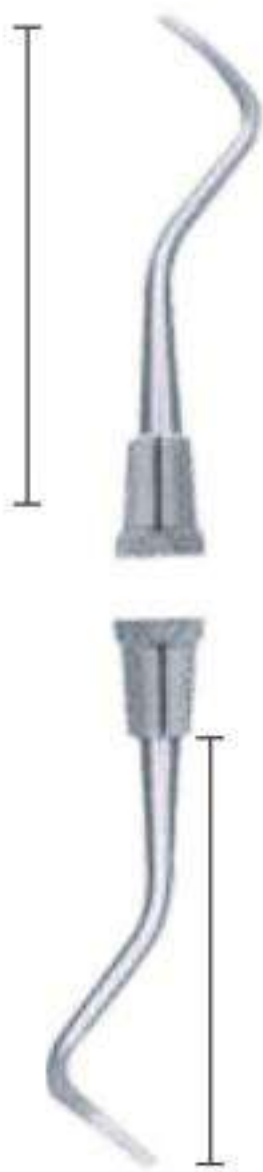

786-871
27
(13-80-8-14)
Mesial



786-872
27
(10-95-8-14)
Distal
#41, #6



786-873
29
(10-80-7-14)
Mesial
#41, #6



786-874
77/78
(15-95-8-12)
Distal



786-875
79/80
(15-80-8-12)
Mesial

ANGLE FORMERS



786-876
30/31
(12-80-5-8)



786-877
32/33
(9-80-4-8)



786-878
34/35
(7-80-2.5-9)

CARVERS INSTRUMENTS

- Инструменты для реставрации
- Instruments a modeler
- Modellierinstrumente

- Инструменты для реставраций
- Instrumentos para modelar
- أدوات تقطيع

P.K. THOMAS WAXING INSTRUMENTS SOLID HANDLE 6MM, LENGTH 170MM

P.K. THOMAS WAXING INSTRUMENTS

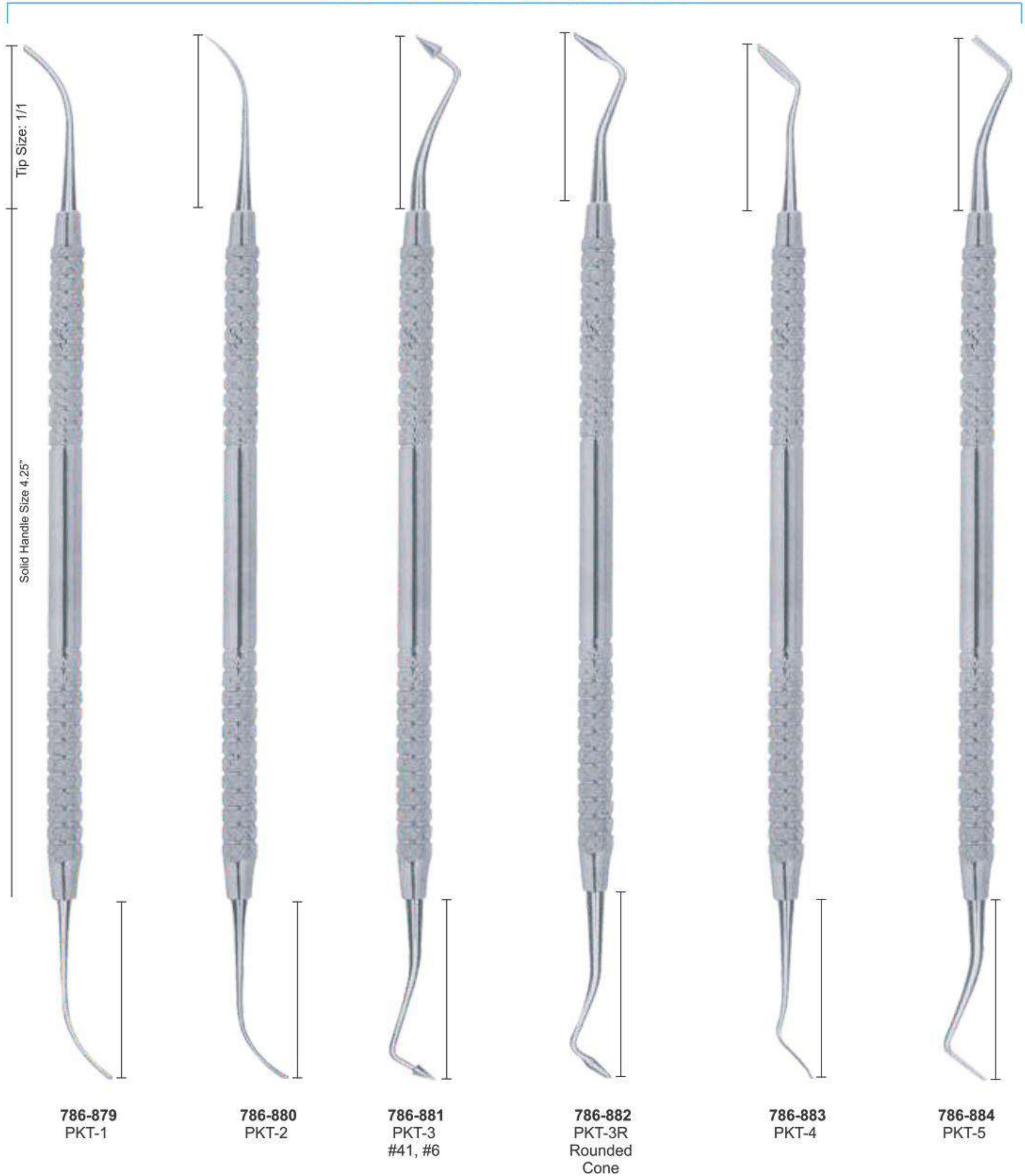

FILLING INSTRUMENTS

- Инструменты для реставрации
- Instruments pour plombage
- Füllungsinstrumente (mit Kontrawinkel)

- Інструменти для реставрації
- Instrumentos para obturaciones
- ملء الصكوك

CHISELS

HOES

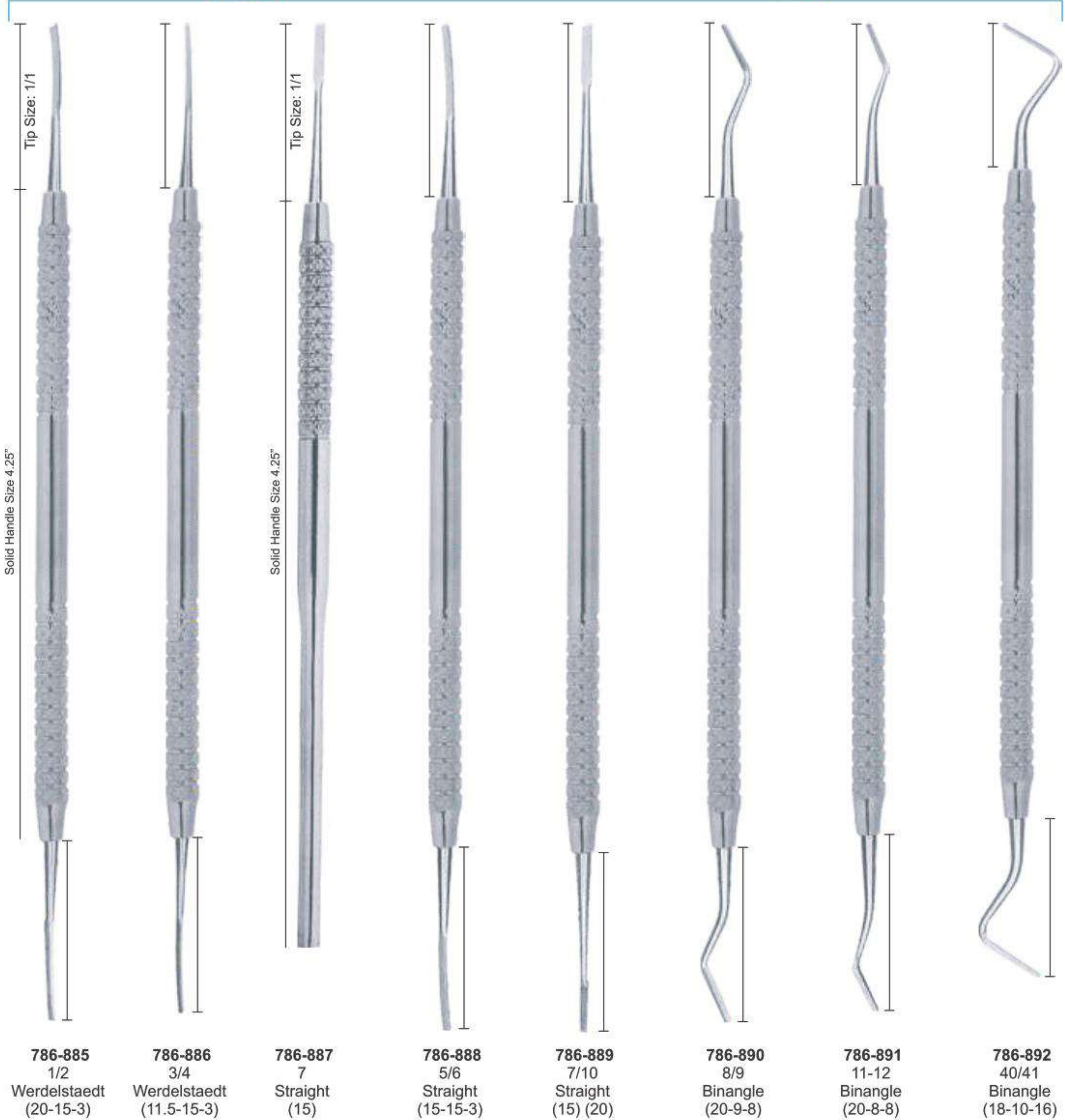

CEMENT SPATULAS

■ Шпатели для цемента
 ■ Spatules à ciment
 ■ Zementspatel

■ Шпателі для цементу
 ■ Espátulas para cemento
 ■ ملاعق الاسمنت



786-893 00
 786-894 0
 786-895 1
 786-896 2
 786-897 3
 786-898 4
 786-899 3
 Weston
 786-900 1
 Medium cement
 786-901 1

786-902 Le Cron
 786-903 Le Cron
 786-904 Le Cron
 786-905 MSY
 786-906 MSY
 786-907 Le Cron
 786-908 Hylin
 786-909 Hylin
 786-910 Hylin
 786-911 Zahle
 786-912 Zahle
 786-913 Zahle
 786-914 Gritman

WAX KNIVES

■ Ножи для воска
 ■ Couteaux a cire
 ■ Wachsmesser

■ Ножи для воску
 ■ Cuchillos para cera
 ■ السكاكين الشمع

ALGINATE, PLASTER SPATULAS, WAX KNIVES PLASTER FOR KNIVES & PLASTER SHEAR



786-915
 Wooden Handle
 Fig. 5
 21.5 cm



786-916
 Wooden Handle
 Fig. 7
 19.5 cm curved



786-917
 Wooden Handle
 Fig. 8
 20 cm curved



786-918
 Wooden Handle
 Fig. 9
 22.5 cm curved



786-919
 Hook Knives



786-920
 Fig. 1
 Lessmann
 12.5 cm



786-921
 Fig. 2
 Lessmann
 17 cm



786-922
 Fig. 1
 with small spoon
 12.5 cm



786-923
 Fig. 2
 with large spoon
 17 cm



786-924
 Bacolite Handle
 Wax Knives,
 Small



786-925
 Bacolite Handle
 Wax Knives,
 Large



786-926
 Wooden Handle
 Wax Knives,
 Small



786-927
 Wooden Handle
 Wax Knives
 Large



786-928
 Plaster Knives



786-929
 Fig. 1
 17 cm



786-930
 Fig. 3
 16 cm



786-931
 Fig. 4
 16 cm



786-932
 Special Inox
 19.5 cm

ARTICULATORS

■ Артикуляторы
■ Artocilar
■ Artikulations

■ Артикулятори
■ Articuler
■ آرتیکولاتورس



786-933

Technical Datas:

Intercondylar distance
condylar inclination
Bennet angle
Incisal table inclination
Distance between mounting plates
Weight
Opening (Item 5000)
Opening (5010)

120 mm
fixed at 30°
fixed at 7°
10°
85 mm
400 gr.
125°
180°

786-934

Technical Datas:

Intercondylar distance
condylar inclination
Bennet angle
Incisal table inclination
Distance between mounting plates
Weight
Opening

110 mm
fixed at 30°
fixed at 7°
flat
85 mm
45 gr.
180°

786-935

Stainless Steel Finishing
786-936
Royal Blue



786-937



786-938



786-939



786-940

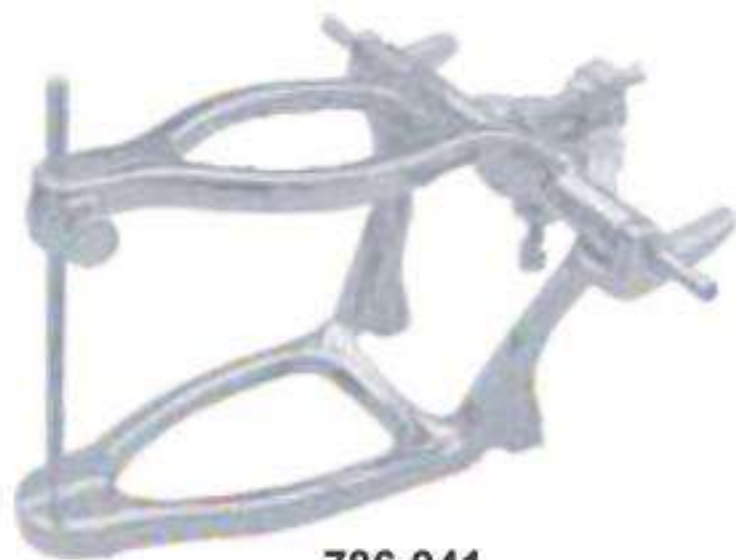

786-941



786-942



786-943



786-944

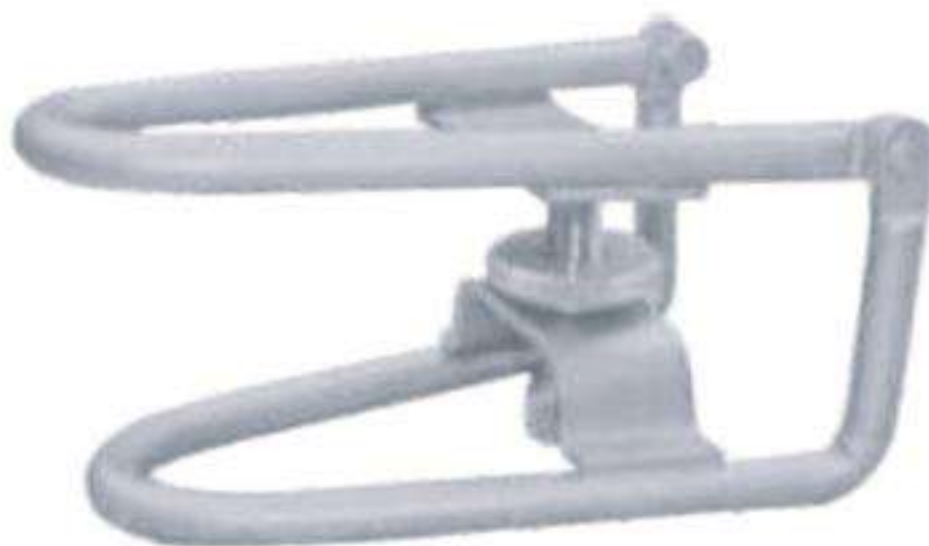

786-945



786-946

Nakawalni
Dental Laboratory
Instrument

MAXILLOFACIAL SURGERY INSTRUMENT

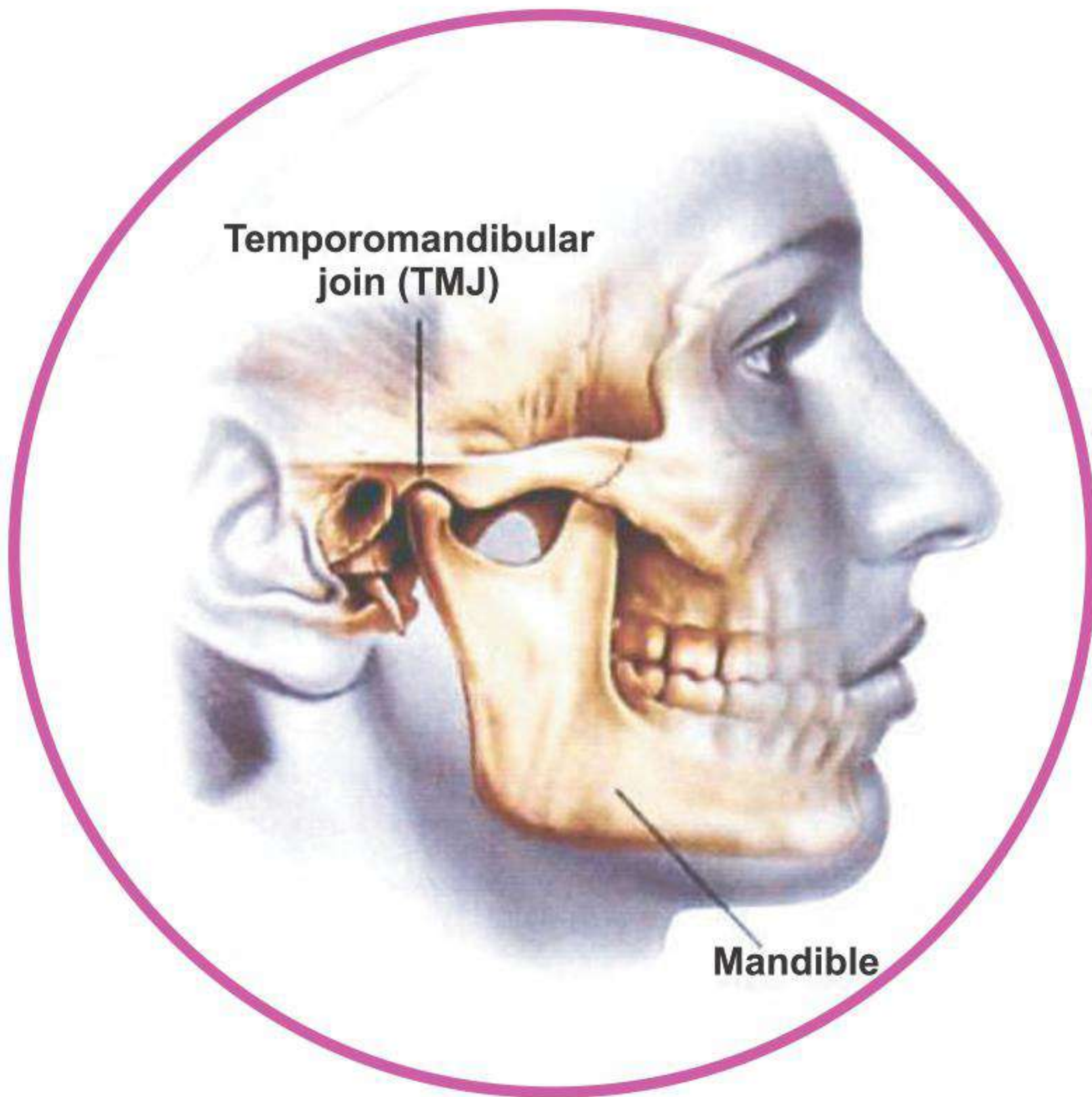

RETRACTORS - MOUTH GAGS

- Роторасширители
- Ecarteurs - Ouvre-bouches
- Vesibulumabhalter / Mundspanner

- Роторозширювачі
- Separadores-Abre-bocas
- الكامشات.الكمامات الفم



786-947
Mouth Gag Molt
11 cm for (Children)



786-948
Mouth Gag Molt
14 cm for (Adults)



Cheek Retractor
786-949 140 mm
786-950 180 mm



Cheek Retractor
786-951 140 mm



786-952
Wangen Holder,
vestibule 15 cm,
with or without
lip protection,



786-953
Wangen Holder,
vestibule 15 cm,
with or without
lip protection,



786-954
Wangen Holder,
Wangen holder with dual
function, 17 cm,



786-955
140 mm

786-956
150 mm

Cheek Retractor

RETRACTORS - MOUTH GAGS

- Роторасширители
- Ecarteurs - Ouvre-bouches
- Vesibulumabhalter / Mundspanner

- Роторозширювачі
- Separadores-Abre-bocas
- الكامشات.الكمامات الفم



786-957
Fig. 1
Weitlaner
10.5cm
13.5cm



786-958
Fig. 2
Weitlaner
10.5cm
13.5cm



786-959
Stainless Steel
Double
Ended Cheek
Retractors



786-960
Stainless Steel
Single
Ended Cheek
Retractors



Weitlander
786-961 11 cm
786-962 13 cm
786-963 15 cm



786-967
Denhard
12 cm



786-968
Roser-König
16 cm



786-969
Roser-König
19 cm



Jennings
786-964 11 cm
786-965 13 cm
786-966 15 cm

RETRACTORS

Wound, Bendable
Retractor, individually or as saving kit!

■ Роторасширители
■ Ecarteurs
■ Wundhaken

■ Роторозширювачі
■ Separadores
■ الكامشات



786-970
Cheek Retractor
Long



786-971
Cheek Retractor
Long



786-972
Cheek Retractor
Long



**Retractor with
Ergo Grip**
786-973 24 cm
Ergonomic handle



786-974
Cheek Retractors,
Retractor Ivory
Width adjustable
& fixable, 20 cm



**Cheek Retractors,
Tongue Depressors**
786-975 19 cm



**Cheek Retractors,
Minnesota**
786-976 16 cm



Cheek Retractors,
786-977 20 cm
easy to bend
by hand,



**Cheek Retractors,
Retractor and tongue
pushers BISHOP with
comfortable margin,**
786-978 16 cm,



**Cheek Retractors,
Retractor combination
combination,**
786-979 25 cm,

RETRACTORS

- Роторасширители
- Ecarteurs
- Wundhaken

- Роторозширювачі
- Separadores
- الكامشات



786-982
Retractors, Unique
Length 175 mm
angled 45°



786-983
Retractors, Unique
Length 175 mm
angled 90°



786-984
Retractors,
16 cm



786-985
Retractors,
19 cm



786-986
Retractors, Mini-Langenbeck
16 cm, hooks 22 mm,



786-987
Retractors, Cheek
Retractor combination
21 cm, 2

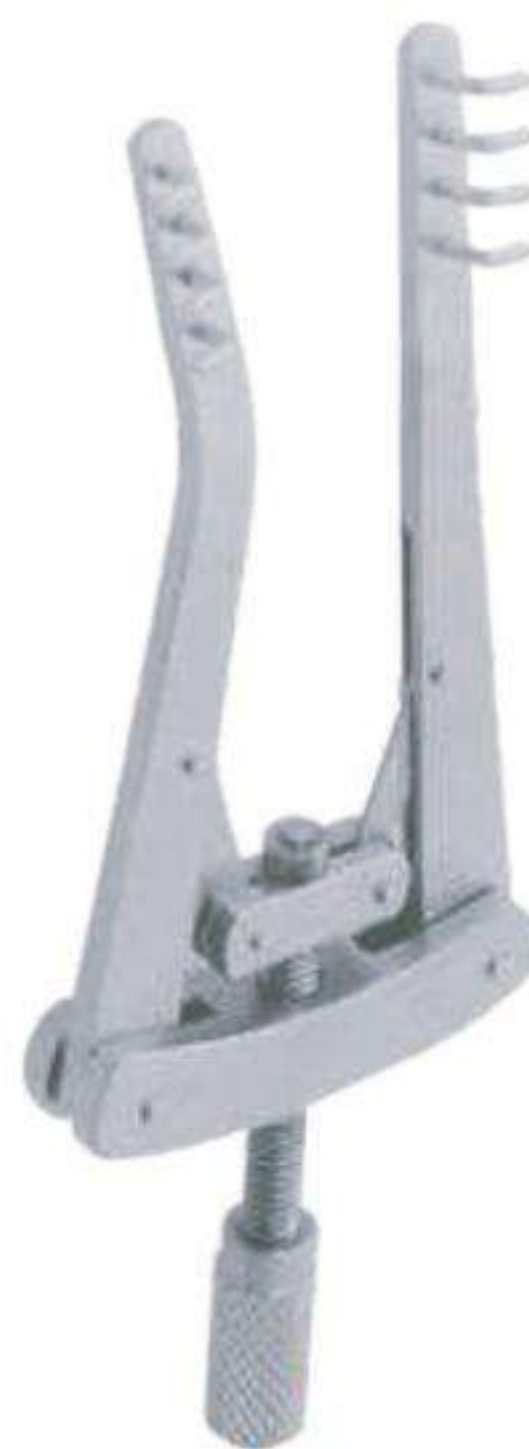

786-988
Mini Retractor
about 8 cm,



786-989
Retractors,
17 cm, hooks 22 mm

RETRACTORS

■ Роторасширители
 ■ Ecarteurs
 ■ Wundhaken

■ Роторозширювачі
 ■ Separadores
 ■ الكامشات



30 x 16 mm

786-990
Retractors, surgical-flat
 surgically-flat, 21 cm, hook
 30 x 16 mm



786-991
Retractors, surgical-flat
 surgically-flat, 21 cm, hook
 42 x 11 mm



60 x 12 mm

786-992
Retractors, surgical-flat
 surgically-flat, 21 cm, hook
 63 x 12 mm



Retractors, surgical-flat
 surgically-flat, 21 cm, hook
786-993 30x16 mm
786-994 42x11 mm
786-995 63x12 mm



Retractors, Lengenbeck
 21 cm, hook
786-996 30x11 mm
786-997 30x16 mm



786-998
Retractors
 21 cm



786-999
Farabeuf
 (120 x 12mm)
 Set of 2 pices



786-1000
Retractor Seldin



786-1001
FELDMAN
Retractor
 5-1/2", 14cm

GUM SCISSORS

- Ножницы десневые
- Ciseaux a gencives
- Zahnfleischscheren

- Ножиці для ясен
- Tijeras para encias
- متص صمغ



786-1002
Iris
115mm
Straight



786-1003
Iris
115mm
Curved



786-1004
Goldman-Fox
130mm
Saw edge, straight



786-1005
Goldman-Fox
130mm
Saw edge, Curved



786-1006
La Grang
115mm
Saw edge, double Curved



Mayo
786-1007 140mm
786-1008 170mm
786-1009 230mm
Straight



Mayo
786-1010 140mm
786-1011 170mm
786-1012 230mm
Curved



Metzenbaum
786-1013 145mm
786-1014 180mm
786-1015 200mm
Straight



Metzenbaum
786-1016 145mm
786-1017 180mm
786-1018 200mm
Curved



786-1019
Kelly
160mm
Straight



786-1020
Kelly
160mm
Curved



786-1021
Iris
115mm
Straight

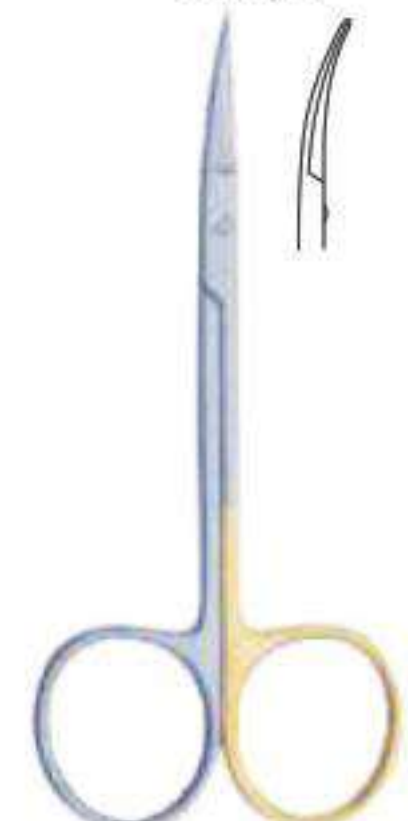

786-1022
Iris
115mm
Curved

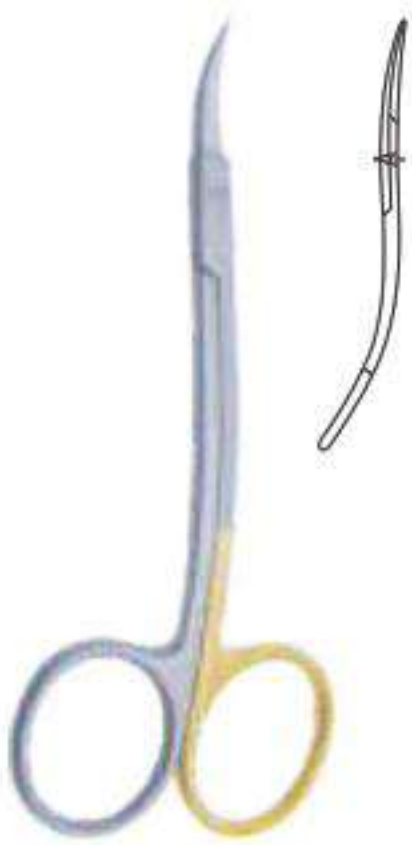

786-1023
La Grange
115mm
Double Curved



786-1024
Goldman-fox
130mm,
Straight



786-1025
Goldman-fox
130mm,
Curved



786-1026
Kelly
160mm, curved



786-1027
Iris
115mm, Straight



786-1028
Iris
115mm, Curved

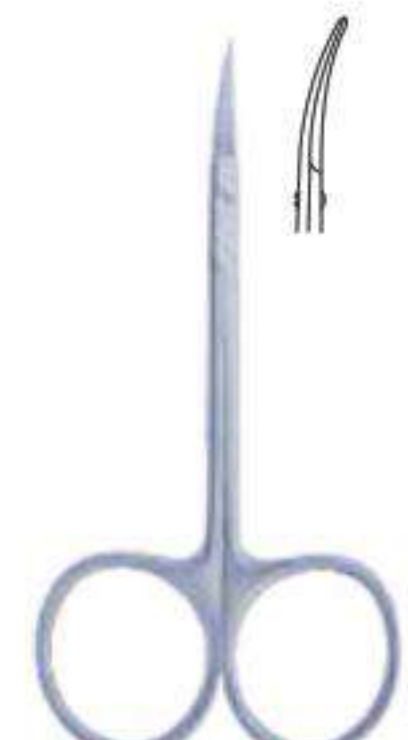

786-1029
Micro Iris
90mm, Curved

GUM SCISSORS

■ Ножницы десневые
 ■ Ciseaux a gencives
 ■ Zahnfleischscheren

■ Ножиці для ясен
 ■ Tijeras para encias
 ■ مقص صمغ



786-1030
 Iris
 115mm,
 Angled



786-1031
 Iris
 115mm,
 Curved



786-1032
 Goldman-Fox
 130mm,
 Saw edge, straight



786-1033
 Goldman-Fox
 130mm,
 Saw edge, curved



786-1034
 Goldman-Fox
 130mm,
 Saw edge,
 double curved



786-1035
 La Grange
 115mm,
 Saw edge,
 double curved



786-1036
 Neumann
 120mm,
 Saw edge,
 double curved



786-1037
 Kilner (Ragnell)
 120mm,
 Straight



786-1038
 Kilner (Ragnell)
 120mm,
 Curved



786-1039
 Joseph
 140mm,
 Straight



786-1040
 Joseph
 140mm,
 Curved



786-1041
 Kelly
 160mm,
 Straight



786-1042
 Kelly
 160mm,
 Curved



786-1043
 Lockin
 160mm,
 Saw edge,
 angular



786-1044
 Lockin
 120mm,
 160mm
 Saw edge,
 angular



786-1045
 Dean
 170mm,
 Saw edge,
 angular



786-1046
 Spencer
 90mm



786-1047
 Spencer
 130mm



786-1048
 Spencer
 115mm



786-1049
 Noyes
 110mm, straight



786-1050
 Noyes
 110mm, curved



786-1051
 Noyes
 110mm,
 Angular



786-1052
 Castroviejo
 150mm
 Curved

NEEDLE HOLDERS

■ Иглодержатели
■ Porte-aiguilles
■ Nadelhalter

■ Голкотримачи
■ Porta-agujas
■ اصحاب ابرة

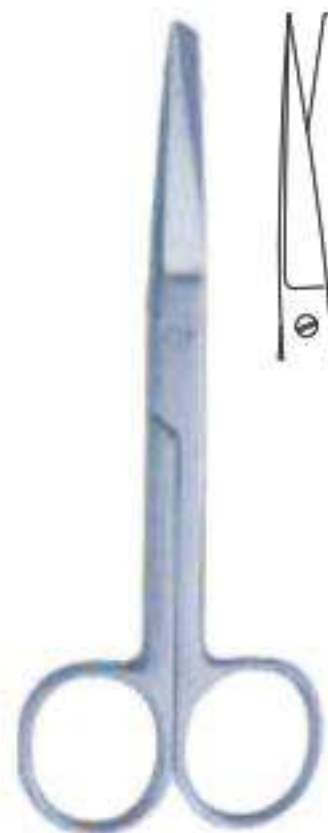

786-1053
130mm
Straight



786-1054 Mayo Mayo
130mm 130mm
786-1055 160mm 160mm
786-1056 180mm 180mm
straight curved

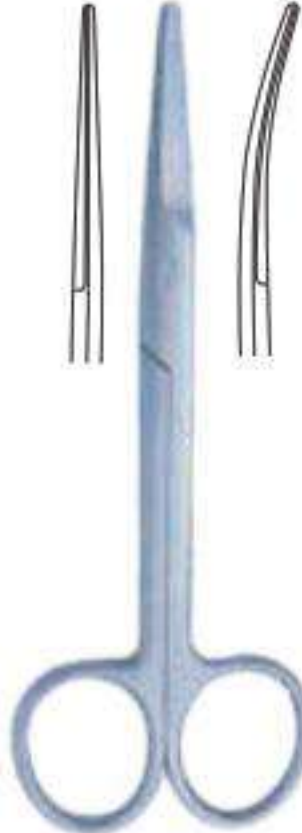

786-1057 Mayo Mayo
140mm 140mm
786-1058 200mm 200mm
straight curved



786-1059 Metzenbaum
145mm 145mm
786-1060 200mm 200mm
straight curved



786-1061
Beebee
110mm
Saw edge,
straight



786-1062
Beebee
110mm
Saw edge,
curved



786-1063
Beebee
110mm
Saw edge, straight



786-1064
Beebee
110mm
Saw edge, curved



786-1065
Universal
120mm



786-1066
Universal
120mm

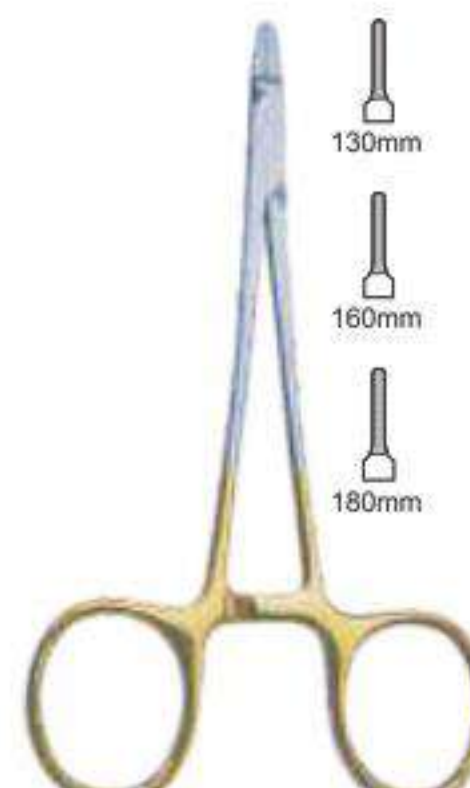

Crile
786-1067 130mm
786-1068 150mm
786-1069 180mm



786-1070
Halsey
130mm



786-1071
Baumgartner
130mm



786-1072
Derf
120mm



786-1073
Delicate
150mm



Mayo-Hegar
786-1074 130mm
786-1075 160mm
786-1076 180mm
786-1077 200mm



786-1078
Crile-Wood
150mm
straight

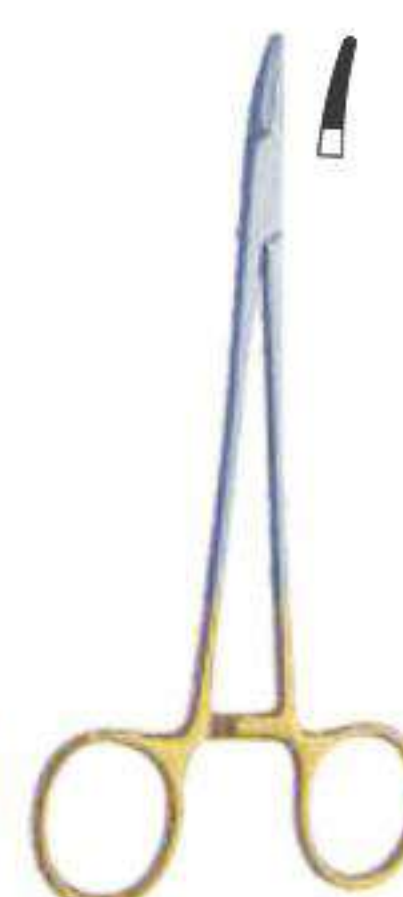

786-1079
Crile-Wood
150mm
curved

NEEDLE HOLDERS

■ Иглодержатели
■ Porte-aiguilles
■ Nadelhalter

■ Голкотримачи
■ Porta-agujas
■ اصحاب ابرة

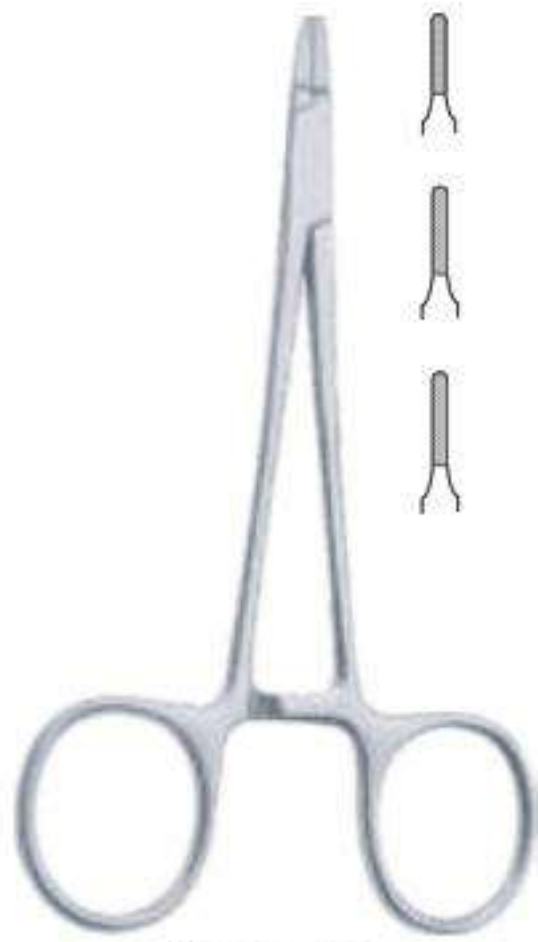

Castroviejo
786-1080 130mm
786-1081 150mm
786-1082 180mm



786-1083
Halsey
130mm



786-1087
Baumgartne
130mm



786-1085
Derf
120mm



786-1086
Delicate
150mm



786-1087
Adson
170mm



Mayo-Hegar
786-1088 130mm
786-1089 160mm
786-1090 180mm
786-1091 200mm



786-1092
Crile-Wood
150mm



Castroviejo
786-1093 str 140mm cvd
786-1094 str 180mm cvd



Olsen-Hegar Needle
Holder with Scissors
786-1095 140mm



Gillies Needle
Holder with Scissors
786-1096 160mm



Mathieu
786-1097 140mm
786-1098 170mm



Castroviejo
786-1099 str 140mm cvd
786-1100 str 180mm cvd



Olsen-Hegar Needle
Holder with Scissors
786-1101 140mm



Gillies Needle
Holder with Scissors
786-1102 160mm

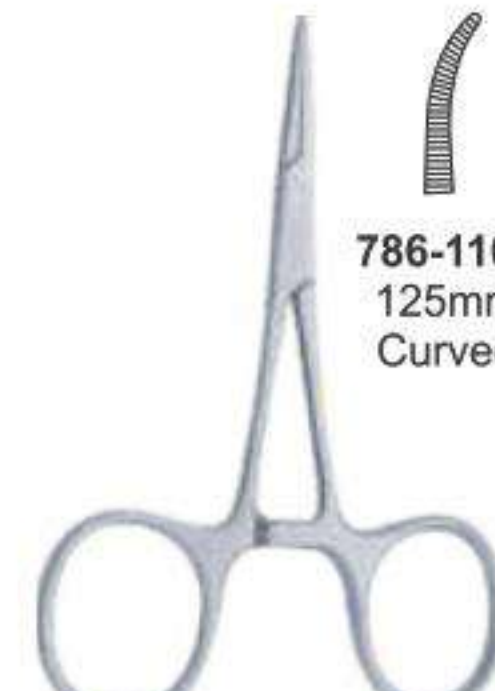

Hartmann (Baby Mosquito)
786-1103 90mm straight

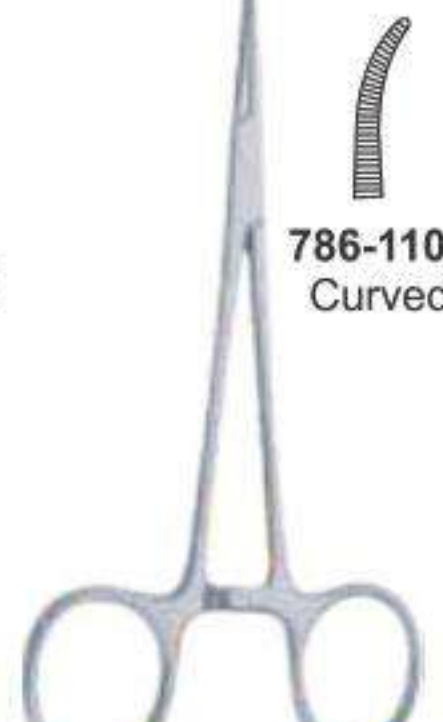

Halstead Mosquito
786-1105 125mm
Straight

786-1104
125mm
Curved

786-1106
Curved

HAEMOSTATIC FORCEPS & TOWEL CLAM

- Зажимы артериальные, зажимы для салфеток
- Pinces hemostatiques, Pincas a compresas
- Arterienklemmen, Tuyschklemmen

- Затискачі артеріальні, затискачі для серветок
- Pinzas hemostaticas, Pincas para compresas
- الملقط هایموستاتیک المشابک منشفه

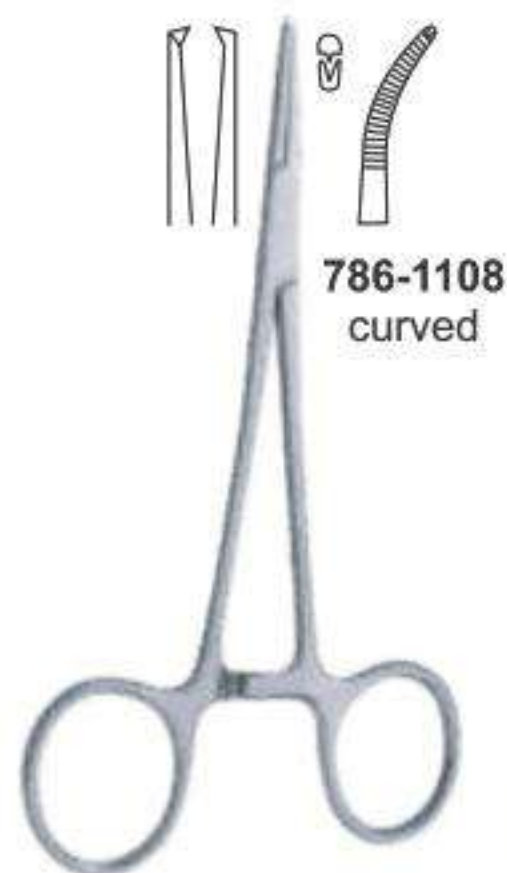

786-1108 curved

Halstead Mosquito 1x2
786-1107 125mm straight



786-1110 curved

Kelly
786-1109 140mm straight

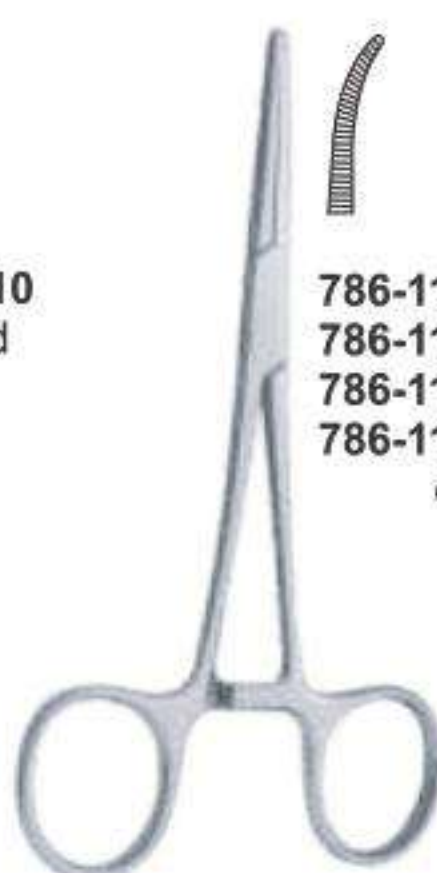

786-1115 140mm
786-1116 160mm
786-1117 180mm
786-1118 200mm curved

Rocheter-Pean
786-1111 140mm
786-1112 160mm
786-1113 180mm
786-1114 200mm straight

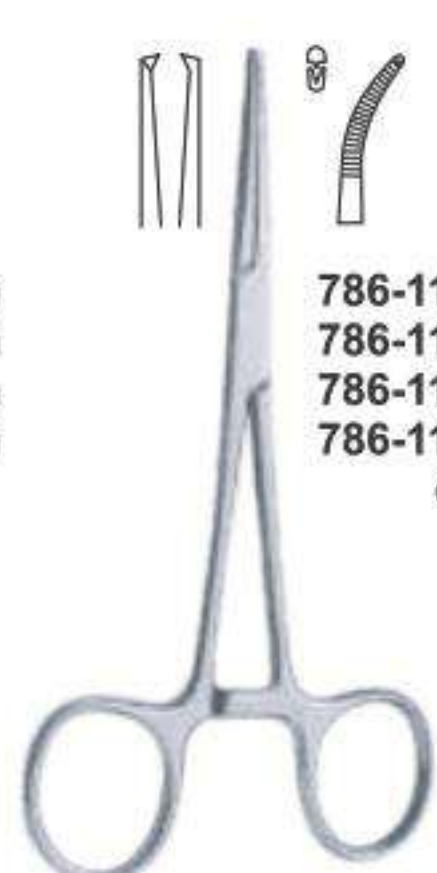

786-1123 140mm
786-1124 160mm
786-1125 180mm
786-1126 200mm curved

Rocheter-Kocher 1x2
786-1119 140mm
786-1120 160mm
786-1121 180mm
786-1122 200mm straight



786-1128 curved

786-1127 Kelly-Rankin
160mm straight

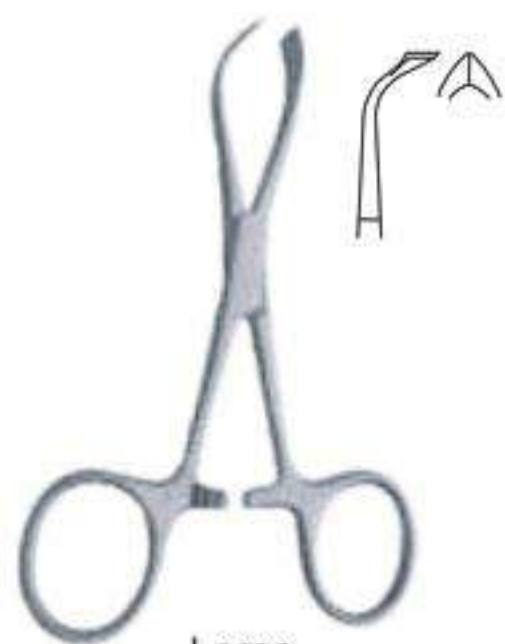

Lorna
786-1129 100mm
786-1130 130mm



786-1131 Allis-Baby 3:4
150mm



786-1132 Allis 4:4
200mm



786-1133 Allis 6:7
200mm



Backhaus
786-1134 140mm Not-perforating and not-damaging



786-1135 Backhaus
130mm



786-1136 Backhaus
85mm



786-1137 Jones
90mm

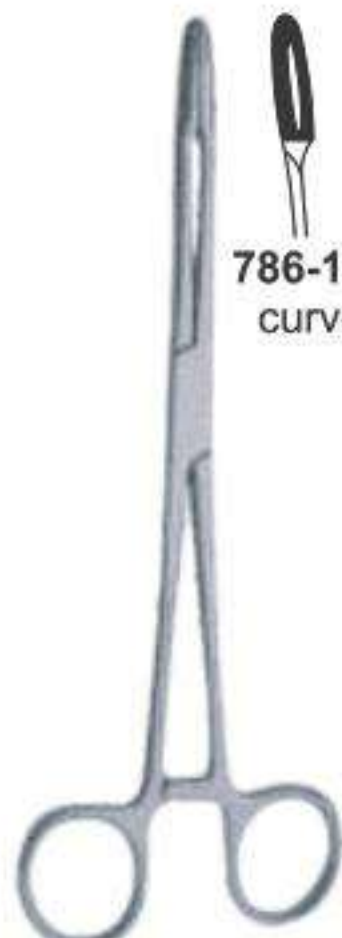

Gross Maier Dressing Forceps
786-1138 200mm straight



Foerster Dressing Forceps
786-1140 200mm



Young Tongue Forceps
786-1141 170mm



Collins Tongue Forceps
786-1142 170mm

786-1139 curved

Spare rubber

RUBBER DAM CLAMPS FORCEPS

■ Инструменты для системы коффердам
 ■ Pincas porte-crampons a digue
 ■ Kofferdam Klammerzangen

■ Инструменти для системи коффердам
 ■ Pinzas de engrapar para dique de caucho
 ■ السدالمطاط الملقط المشابك



786-1143

On request the Content of the rubber dam kit can be changed with other instruments.

Content:

- 01 Anisworth
- 02 Brewer
- 03 Clamps Stand
- 04 Denture Plate
- 05 Rubber Dam Frame
- 06 Rubber Dam Box Lower Case
- 07 Rubber Dam Box Upper Case

- 08 Rubber Dam Clamp Fig. 212
- 09 Rubber Dam Clamp Fig. 211
- 10 Rubber Dam Clamp Fig. 8
- 04 Rubber Dam Clamp Fig. 8A
- 05 Rubber Dam Clamp Fig. 14
- 06 Rubber Dam Clamp Fig. 14A
- 07 Rubber Dam Clamp Fig. 0
- 07 Rubber Dam Clamp Fig. 00
- 07 Rubber Dam Clamp Fig. 2
- 07 Rubber Dam Clamp Fig. 2A
- 07 Rubber Dam Clamp Fig. 7



786-1144
Anisworth



786-1145
Brewer



786-1146
Ivory light weight



786-1147
Palmer



786-1148
Seaparating
Elastic
Plier

RUBBER DAM CLAMPS

■ Кляммера для коффердама
 ■ Crampons pour digue
 ■ Kofferdam Klammern

■ Кляммера для коффердама
 ■ Grapas para dique de caucho
 ■ المشابك السد المطاط



786-1149
Fig. 15



786-1150
Fig. 18



786-1151
Fig. 24



786-1152
Fig. 25



786-1153
Fig. 26



786-1154
Fig. 28



786-1155
Fig. 30



786-1156
Fig. 31



786-1157
Fig. 51



786-1158
Fig. 138



786-1159
Fig. 139



786-1160
Fig. 200



786-1161
Fig. 201



786-1162
Fig. 202



786-1163
Fig. 203



786-1164
Fig. 204



786-1165
Fig. 205



786-1166
Fig. 3



786-1167
Fig. W3



786-1168
Fig. 4



786-1169
Fig. 56A



786-1170
Fig. 7



786-1171
Fig. 7A



786-1172
Fig. 8



786-1173
Fig. 8A



786-1174
Fig. W8A



786-1175
Fig. 10



786-1176
Fig. 11



786-1177
Fig. 12A



786-1178
Fig. 13A



786-1179
Fig. 14



786-1180
Fig. 14A



786-1181
Fig. 14AN



786-1182
Fig. 22



786-1183
Fig. 27



786-1184
Fig. 207



786-1185
Fig. 29



786-1186
Fig. 206



786-1187
Fig. 208



786-1188
Fig. 209



786-1189
Fig. 1



786-1190
Fig. 1A



786-1191
Fig. 2



786-1192
Fig. 2A



786-1193
Fig. W2A



786-1194
Fig. 0



786-1195
Fig. 00



786-1196
Fig. 210



786-1197
Fig. 211



786-1198
Fig. 212



786-1199
Fig. 6



786-1200
Fig. 9



786-1201
Fig. N06



786-1202
Fig. U67



786-1203
Fig. 214



786-1204
Fig. P1



786-1205
Fig. P2



786-1206
Fig. G-1



786-1207
Fig. G-2

CROWN REMOVER

- Инструменты для удаления коронок
- Arrche-couronnes
- Teleskopkronenzangen

- Инструменты для видалення коронок
- Arranca-corona
- مزيلات التاج



786-1210
Crown Spreaders



786-1211
Mershon
14 cm
Band Pusher



786-1212
Fig. 0



786-1213
Manual
Crown Remover



786-1214
Complete with 3 tips
and tightening keys



semi-automatic crown
& bridge remover



786-1215



786-1216
Manual Crown Remover



MATRIX RETAINERS

- Матрицедержатели
- Porte Matrices
- Matrizenspanner

- Матрицеутримувачи
- Porta Matrices
- مصفوفة الخدم



786-1217
Fig. 5
Ivory 8
5 cm



786-1218
Fig. 6
Ivory 8
6 cm



786-1219
Fig. 7
Ivory 8
7 cm



786-1220
Fig. 1
Tofflemire-Universal

Siqveland retainers



786-1221
Fig. 2
Tofflemire-Junier



786-1222
Fig. 3
Tofflemire-Senior



786-1223
Narrow



786-1224
Wide

Amalgam Well



786-1225
Stainless Steel
Amalgam Well



786-1226
Ivory 12



786-1227
Ivory 1



786-1228
Ivory



786-1229
Elliot

MALGAM INSTRUMENTS & SCALPEL HANDLES

■ Инструменты для амальгамы
 ■ Instruments pour amalgame
 ■ Amagamis/ nstrumente

■ Инструменти для амальгами
 ■ Instrumentos para amalgama
 ■ الصكوك الملعق

■ Ручки для скальпелей
 ■ Manches de bistouris
 ■ Skalpelligriffe

■ Ручки для скальпелів
 ■ Mangos de bisturi
 ■ مشرط مقابض



786-1230
 Fig. 10
 165mm
 English pattern



786-1231
 Fig. 1
 185mm
 German pattern



786-1232
 Fig. 1
 150mm
 Swiss pattern



786-1233
 Fig. 1
 150mm



786-1234
 Fig. 2
 150mm, 45°



786-1235
 Fig. 3
 140mm, 90°



786-1236
 Fig. 3
 5" (12.7cm)



786-1237
 Fig. 3G
 5" (12.7cm)



786-1238
 Fig. 4
 5 1/2" (13.7cm)



786-1239
 6 Way Adjustable Angled
 Scalpel Handle



Locks at 90°, 60°, 30°
 Straight, 120°, 150°, 180°
 Angles

AMALGAM INSTRUMENTS

- Инструменты для амальгамы
- Instruments pour amalgame
- Amagamis/ nstrumente
- Инструменти для амальгамн
- Instrumentos para amalgama
- الصكوك اللغم

AMALGAM CARRIERS

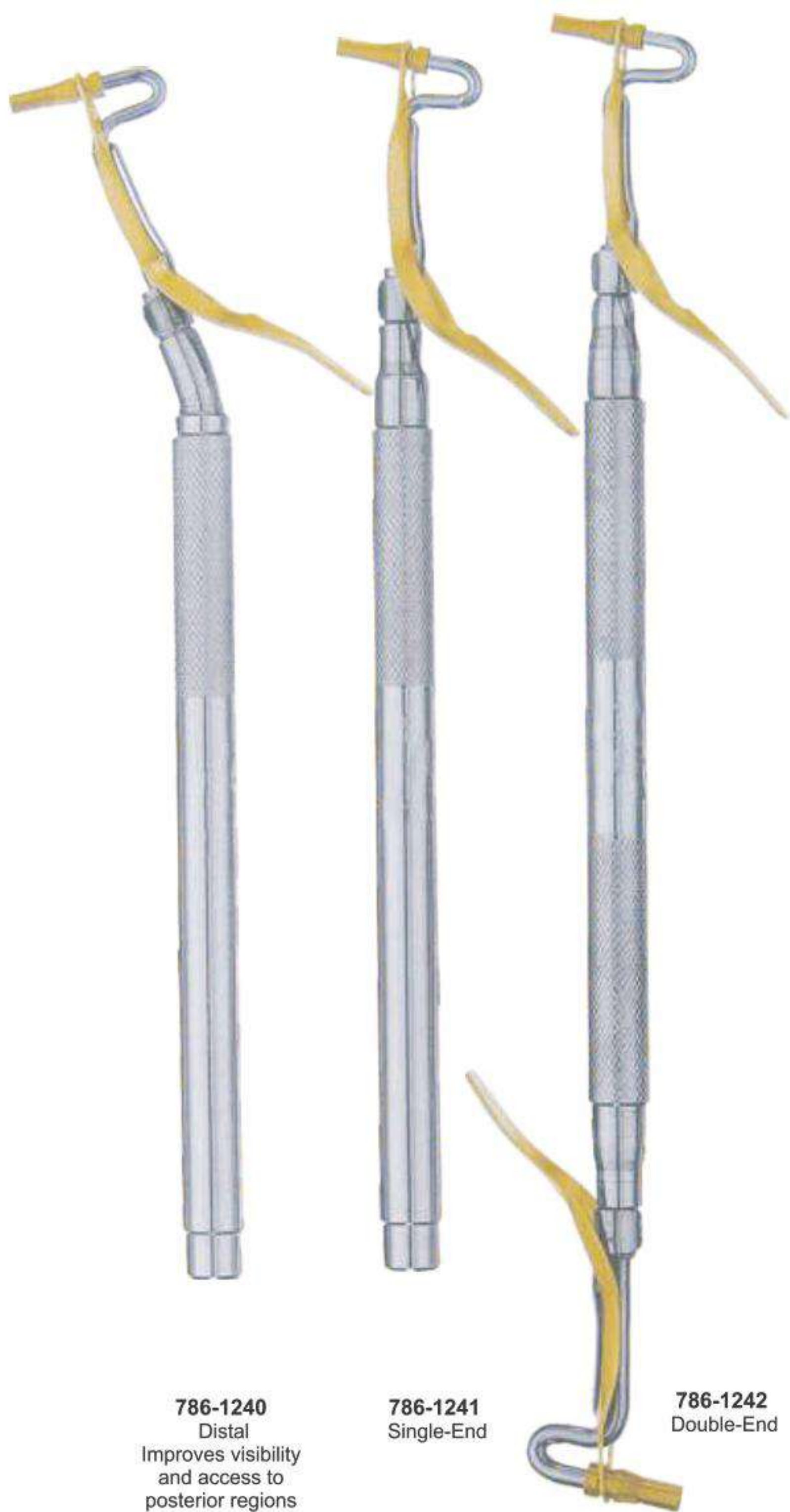

786-1240
Distal
Improves visibility
and access to
posterior regions

786-1241
Single-End

786-1242
Double-End

TIP SIZES FOR DOUBLE-END

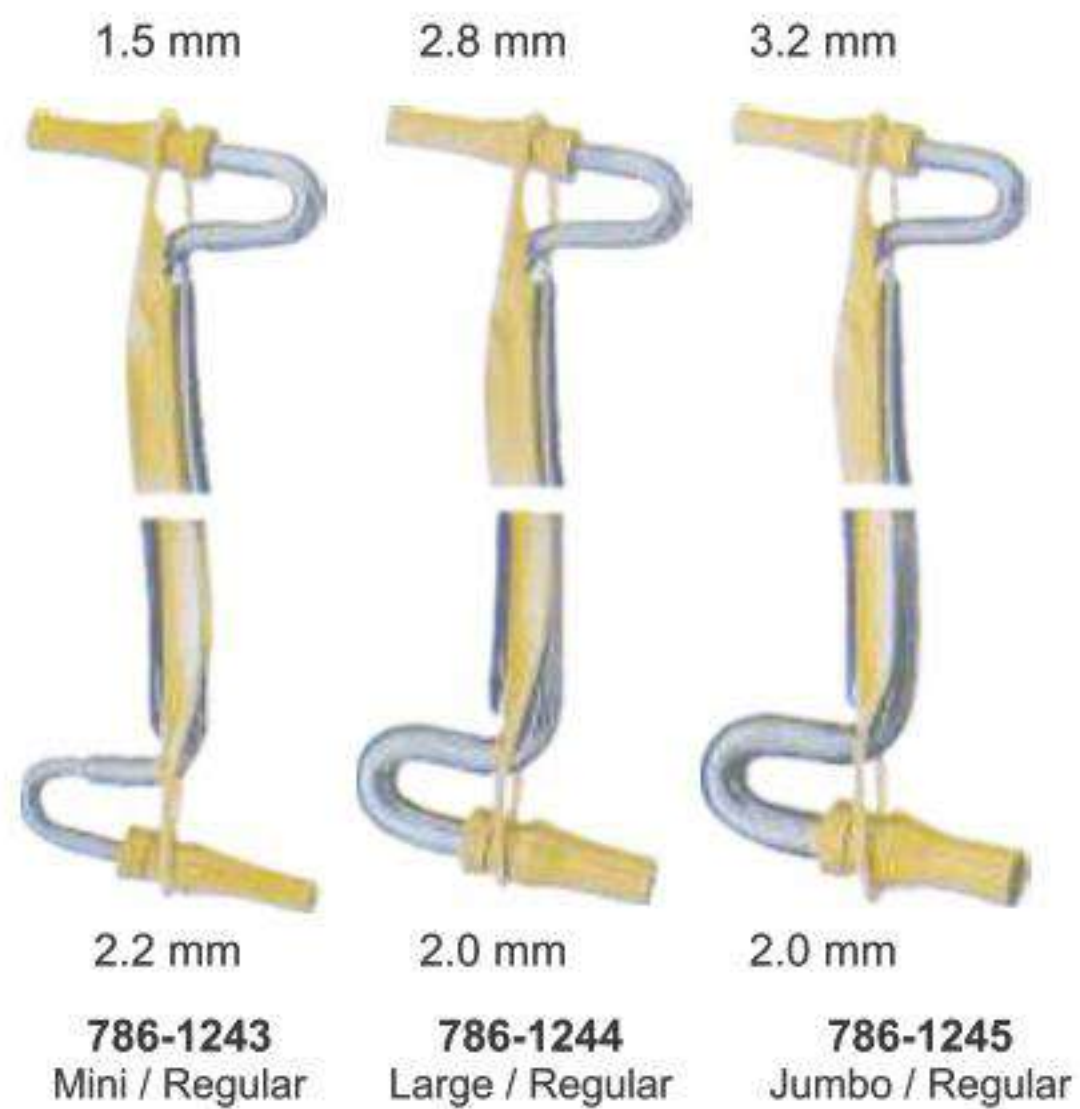

786-1243
Mini / Regular

786-1244
Large / Regular

786-1245
Jumbo / Regular

TIP SIZES FOR DISTAL OR SINGLE-END

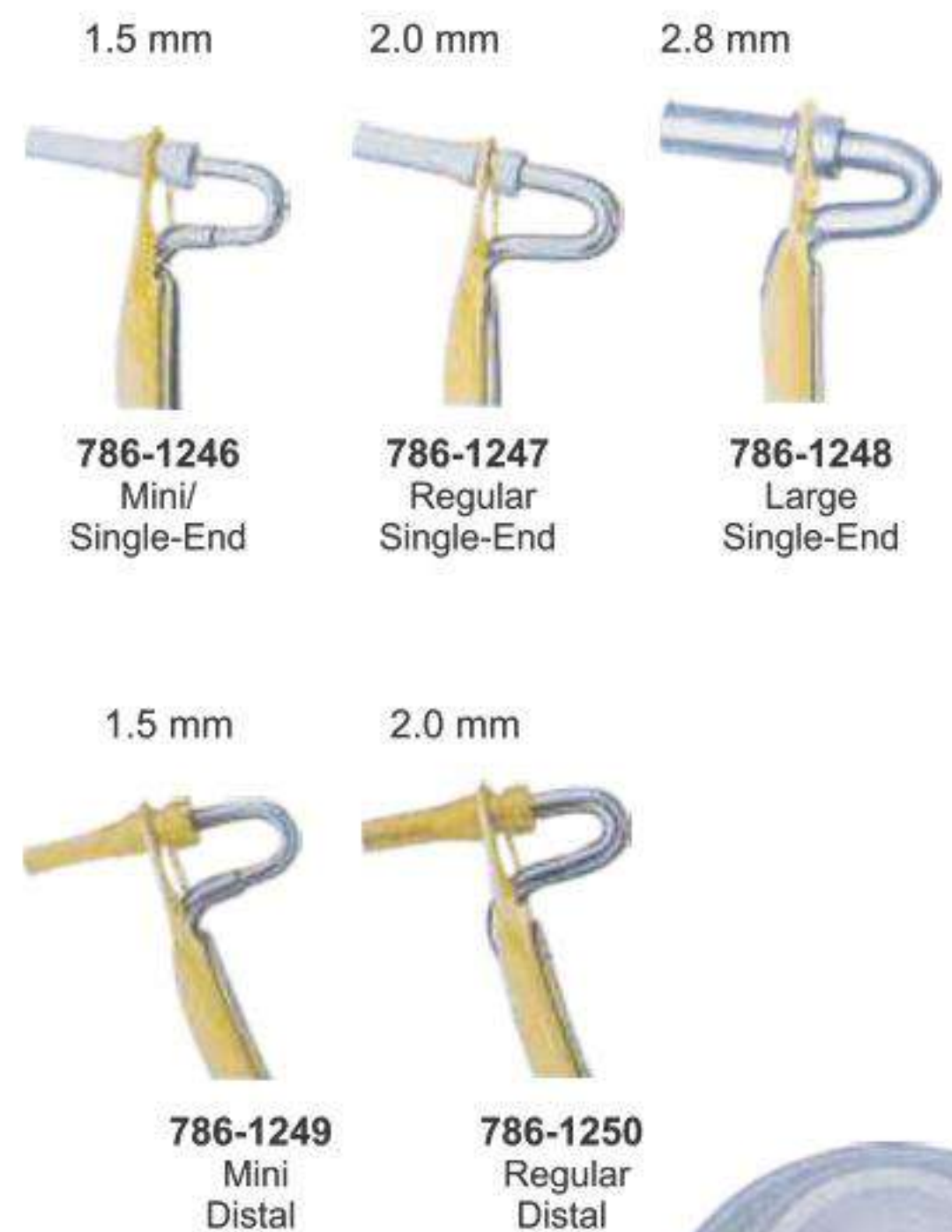

786-1246
Mini/
Single-End

786-1247
Regular
Single-End

786-1248
Large
Single-End

786-1249
Mini
Distal

786-1250
Regular
Distal



786-1251
Amalgam
Well

ROOT PLANNING FILES & BONE FILES

ROOT PLANNING FILES



786-1252
Krarner-Nevins
Bone Chisel



786-1253
Krarner-Nevins
Bone Chisel



786-1254
Molt 18.5cm
Auto Cleavable
Plastic Tips



786-1255
Mead 18.5cm
Non Auto Cleavable
Plastic Tips.



786-1256
Miller



786-1257
Miller

BONE FILES



786-1258
Miller 21



786-1259
Miller 1X
cross cut



786-1260
Miller 2X
Cross cut



786-1261
Miller 52



786-1262
Wahl 1

PERIODONTAL INSTRUMENTS

- Инструменты пародонтологические
- Instruments pour la parodontologie
- Instrumente für die Parodontologie

- Інструменти пародонтологічні
- Instrumentos para periodoncia
- الصكوك اللثة

PERIOSTEEL ELEVATORS

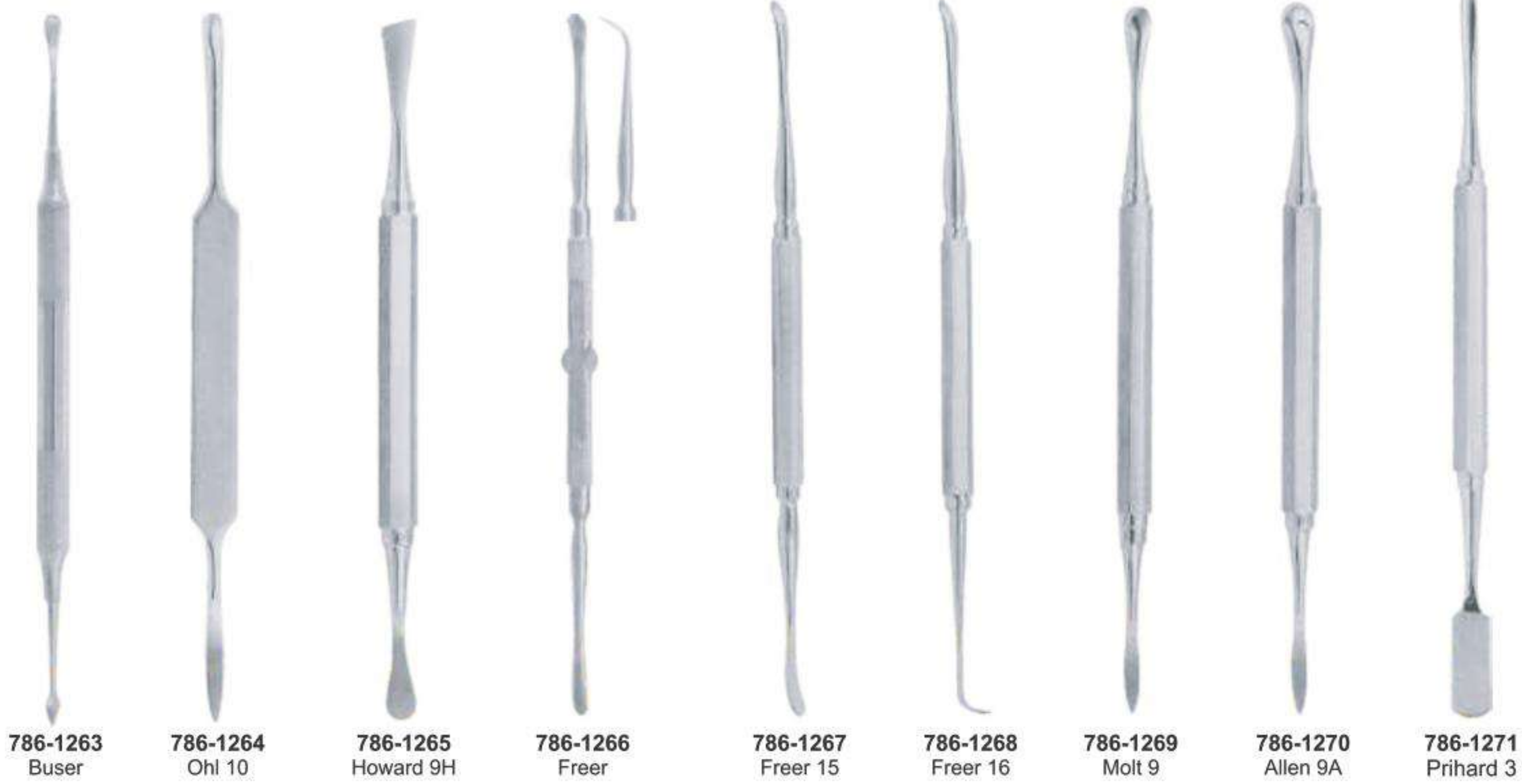

786-1263 Buser 786-1264 Ohl 10 786-1265 Howard 9H 786-1266 Freer 786-1267 Freer 15 786-1268 Freer 16 786-1269 Molt 9 786-1270 Allen 9A 786-1271 Prihard 3



786-1272 Seldin 23 786-1273 Goldman-Fox 14 786-1274 P 24G 786-1275 786-127A 786-127B 786-1276 786-1276A 786-1276B

Raspator, Raspatory
Length 175mm,

Raspator, Williger
Length 170 mm, different widths
(4mm, 5mm, or 7mm)

ORTHODONTIC INSTRUMENTS

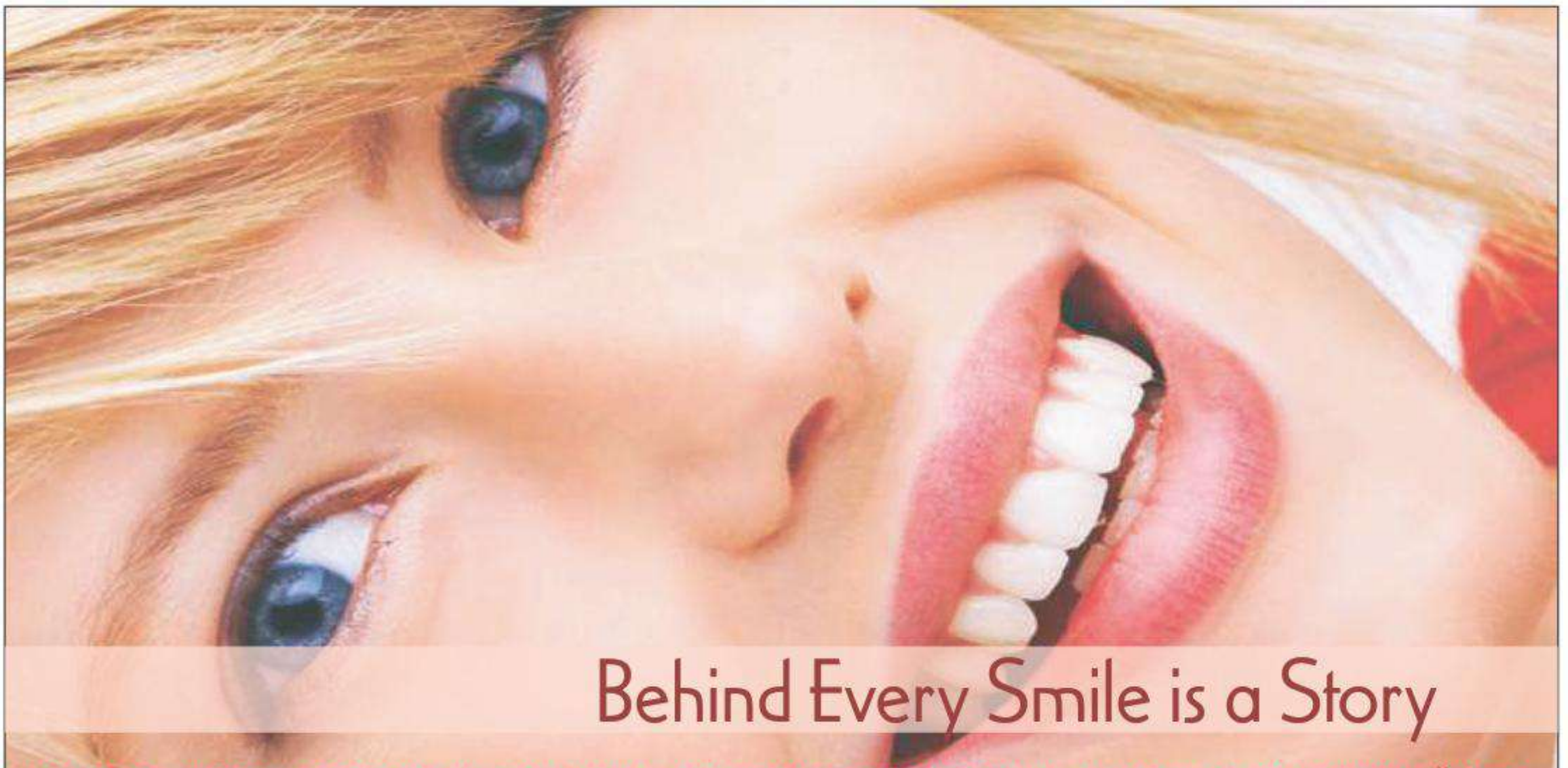

Behind Every Smile is a Story

• QUALITY - ЯКІСТЬ • PRECISION - ТОЧНІСТЬ • ACCURACY - ПРАВИЛЬНІСТЬ • DURABILITY - ЗНОСОКОТІЙКІСТЬ

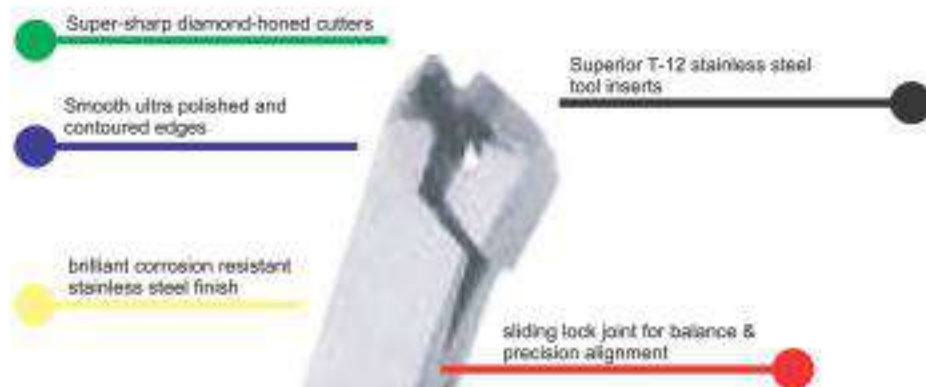

STYLE
A

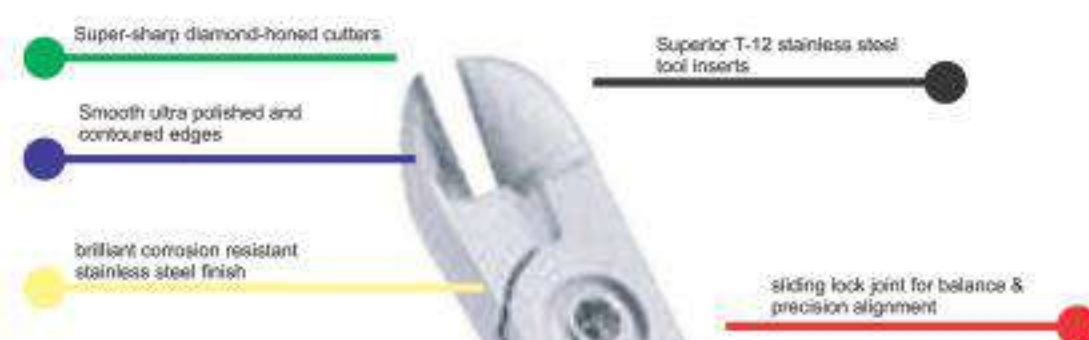

STYLE
B



ORTHODONTIC INSTRUMENTS

■ Инструменты ортодонтические
 ■ Instrumentos Ortodonticos
 ■ Orthodontische Instrumente

■ Инструменти ортодонтични
 ■ Instruments Orthodontiques
 ■ أدوات تقويم الأسنان



786-1277
 Aluminium Height
 Gauge 0.22



786-1278
 Aluminium Height
 Gauge 0.18



786-1279
 Bone Bracket Gauge



786-1280
 Bone Thickness Gauge
 40mm, 180mm



786-1281 OSTEOMETER
 Measuring Forceps for Jaw
 Ridge Width measurement, scale
 on both sides, rustfree, autoclav



786-1282
 Direct bonding
 Bracket holders,
 135mm



786-1283
 Deluxe Bracket
 holder Tweezers



786-1284
 Direct bonding
 Bracket holders,
 136mm



786-1285
 Direct Bond
 Bracket holders,
 Tweezers,
 Small Tip



786-1286
 Direct Bonding
 Bracket holders,
 140mm



786-1287
 Direct Bonding
 Bracket holders,
 135mm



786-1288
 Direct Bonding
 Bracket holder
 140mm

ORTHODONTIC INSTRUMENTS

■ Инструменты ортодонтические
■ Instrumentos Ortodonticos
■ Orthodontische Instrumente

■ Инструменти ортодонтични
■ Instruments Orthodontiques
■ أدوات تقويم الأسنان



786-1289
Band seater auto cleavable



786-1290
Ortho light scaler double ended



786-1291
Ortho light scaler double ended



786-1292
Ortho light scaler double ended



786-1293
Twiel-on elastic module instrument

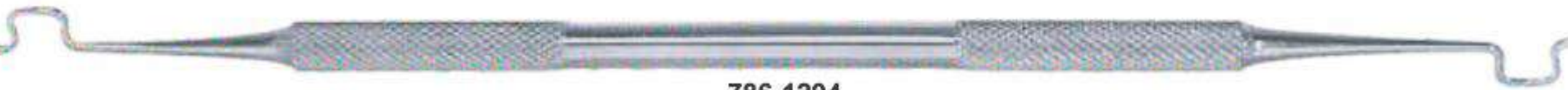

786-1294
Twiel-on elastic module instrument



786-1295
Schure Band Seater



786-1296
Ortho light scaler



786-1297
Ortho light scaler



786-1298
Ortho light scaler heavy



786-1299
Ortho instrument



786-1300
Ortho instrument



786-1301
Ortho light Band Pusher Scaler

ORTHODONTIC INSTRUMENTS

■ Инструменты ортодонтические
■ Instrumentos Ortodonticos
■ Orthodontische Instrumente

■ Инструменти ортодонтични
■ Instruments Orthodontiques
■ أدوات تقويم الأسنان



786-1302
Ortho Light double ended
ligature director



786-1303
Ortho Light double ended
ligature scaler



786-1304
Ortho Light double ended ligature scaler director tivate coil spring
are remove modules with one instruments



786-1305
Ortho band pusher scaler



786-1306
Ortho Light Band Pusher scaler



786-1307
Ortho Ligature director single ended



786-1308
Ortho Light double ended ligature director scaler



786-1309
Ortho Light double ended ligature scaler director
tivate coil spring are remove modules with one instruments



786-1310
Ortho Light double ended ligature director



786-1311
Ortho Light ligature director scaler



786-1312
Ortho Light ligature director double ended



786-1313
Double ended cement spatula



786-1314
Ortho Light scaler single ended

PLIERS FOR ORTHODONTICS & PROSTHETICS

■ Щипці для ортодонції та протезування
 ■ Pincers pour l'orthodontie et la prothèse
 ■ Zanger für Kieferorthopädie und Prothetik

■ Щипці для ортодонції та протезування
 ■ Alicates para ortodoncia y prótesis
 ■ كامشة لتقويم الأسنان بروتيزي

BOX JOINT PLIERS

786-1315
 Universal Dolphin Style
 Wire Bending & cutting pliers

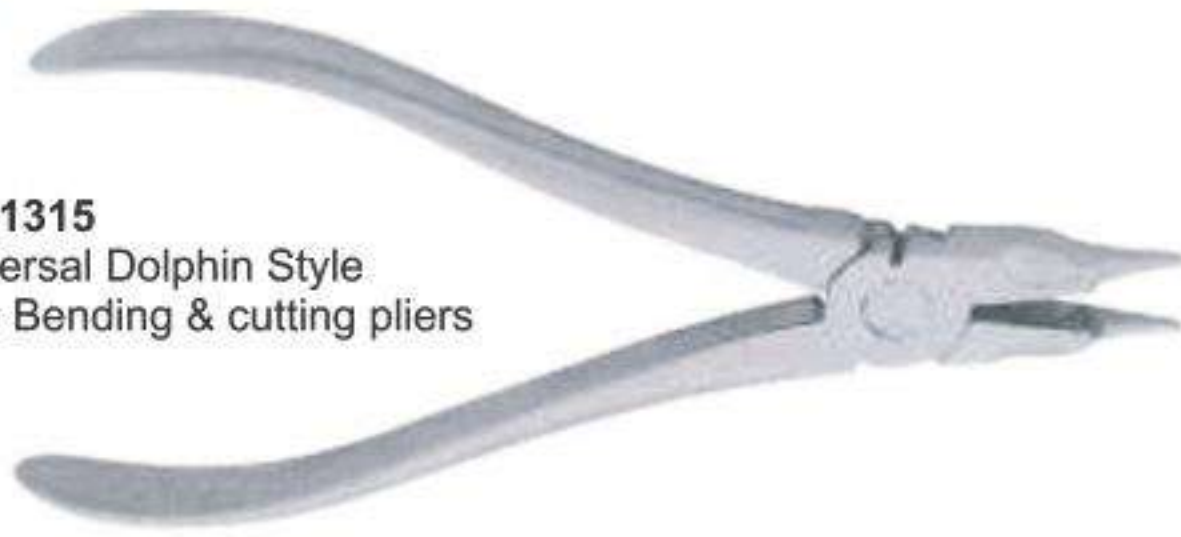

786-1316 Band Removing Plier
 This curved blade of the band removing plier can strip easily and gently remove directly to the tooth, Length 130mm



786-1317
 Tweed Loop forming Pliers



786-1318 How Plier Curved
 Universal usable tool for the multiband technology for wires up to .028" Length 130mm



786-1319 How Plier
 Universal usable tool for the multiband technology for wires up to .028" Length 135mm



786-1320
 Nance Loop forming Pliers



786-1321
Bracket Removing Plier curved
 Bracket Removing curved for easy removal of brackets in the posterior region. Length 130mm



786-1322
 Young Wire Bending & Loop Forming Pliers



786-1323
 Wire Bending & Loop Forming Pliers



786-1324
 Adams, small wire bending and loop forming Pliers



786-1325
Bracket Removing Plier Round Box
 Bracket removing plier for comfortable and quick remover of the brackets. Length 135mm

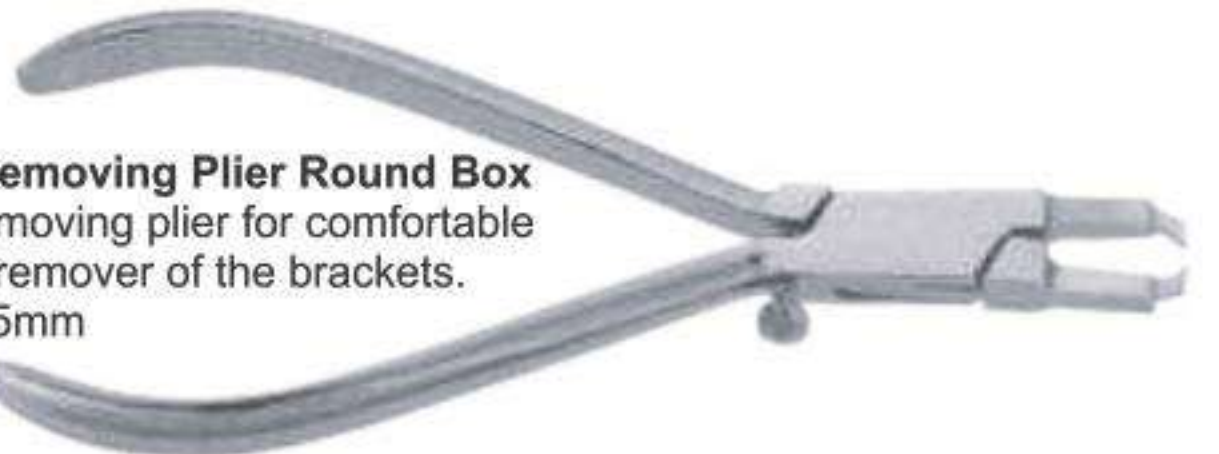

786-1326
Weingart Plier medium
 Weingart plier that are ideal due to their curved tip for setting sheets and is capable of bending the ends Length 145mm



PLIERS FOR ORTHODONTICS & PROSTHETIC

- Щипцы для ортодонтии и протезирования
- Pincers pour l'orthodontie et la prothèse
- Zanger für Kieferorthopädie und Prothetik

- Щипці для ортодонції та протезування
- Alicates para ortodoncia y prótesis
- كماشة لتقويم الأسنان بروتستیس

BOX JOINT PLIERS

786-1327

Adams Plier Round Box

Adams pliers for bending wire arches and bends right angles for wires up to .022", .025 tip to beak Length 125mm



786-1333 **Adams Plier**

Adams pliers for bending wire arches and bends right angles for wires up to .022", .025 tip to beak Length 125mm



786-1328

Falcon Beak Contouring Pliers



786-1334 **Tweed**

Loop Forming Pliers



786-1329

Wires up to 0.020" / 0.7mm



786-1335 **Bird Beak Plier Standard**

Bird Beak Wire bending plier without notches, which is suitable as a universal utility too Length 125mm



786-1330

Johnson Contouring Pliers



786-1336

Mini Ligature cutters



786-1331 **Aderer**

Large wire bending and loop forming pliers



786-1337 **Small Fluch-cut distal and cutting Pliers**

with safety hold fitted with un-breakable, corrosion resistant and durable stainless steel tips



786-1332 **Tweed**

Angle rectangular arch forming & Torquing pliers



786-1338 **Large Fluch-cut distal and cutting Pliers**

with safety hold fitted with un-breakable, corrosion resistant and durable stainless steel tips



PLIERS FOR ORTHODONTICS & PROSTHETICS

■ Щипцы для ортодонтии и протезирования
 ■ Pincers pour l'orthodontie et la prothèse
 ■ Zanger für Kieferorthopädie und Prothetik

■ Щипці для ортодонції та протезування
 ■ Alicates para ortodoncia y prótesis
 ■ كمامشة لتقويم الأسنان بروسشيتيس

BOX JOINT PLIERS

786-1339

Tweed / Angle

1.78mm (.070") wide tips arch forming and torquing pliers



786-1340

Tweed / Angle

1.78mm (.070") wide tips arch forming and torquing pliers



786-1341

Lingual / Palatal arch forming pliers



786-1342

Aderer

Facebow loop forming plier



786-1343

Waldsavhs wire bending and cutting pliers



786-1344 Aderer Plier

For the manufacturing of appliances and activation of wires for wires up to .030" fine tip and up to .036" mean tip
 Length 130mm



786-1345 Large

Contouring Plier



786-1346

Bands & Crowns Plier

In order to skirt



786-1347

Ligature Forming Pliers



786-1348

For double back and triple back bands in 0.30" / 0.7mm & 0.36 / 0.91mm lingual arch wires

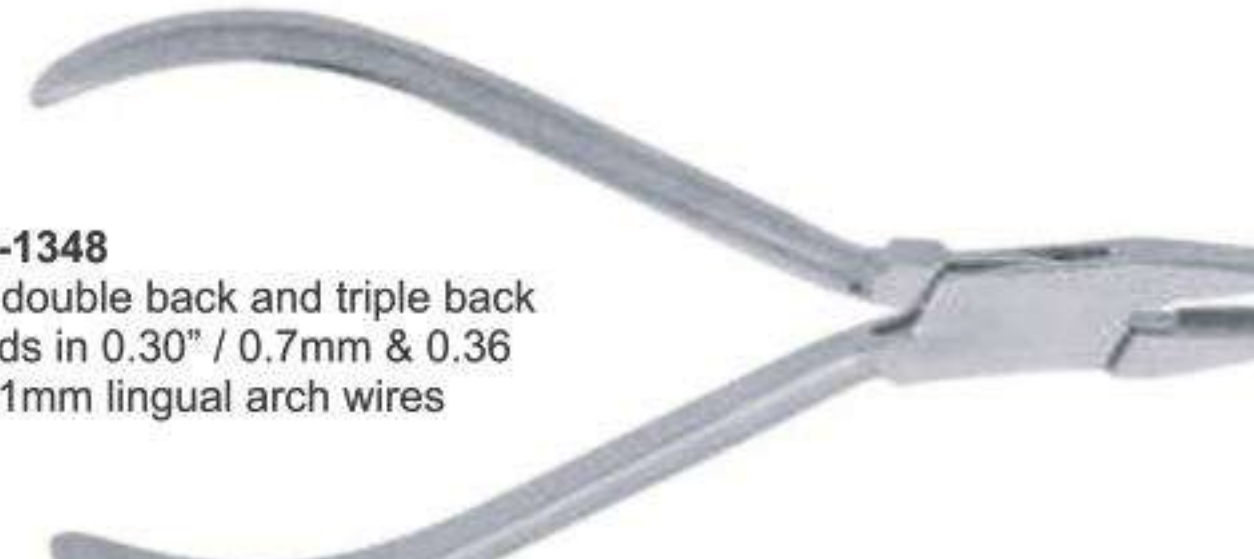

786-1349

Bird Beak Wire Bending & cutting pliers



786-1350

Weingart Plier Medium

Weingart plier that are ideal due to their curved tip for setting sheets and is capable of bending the ends.
 Length 145mm

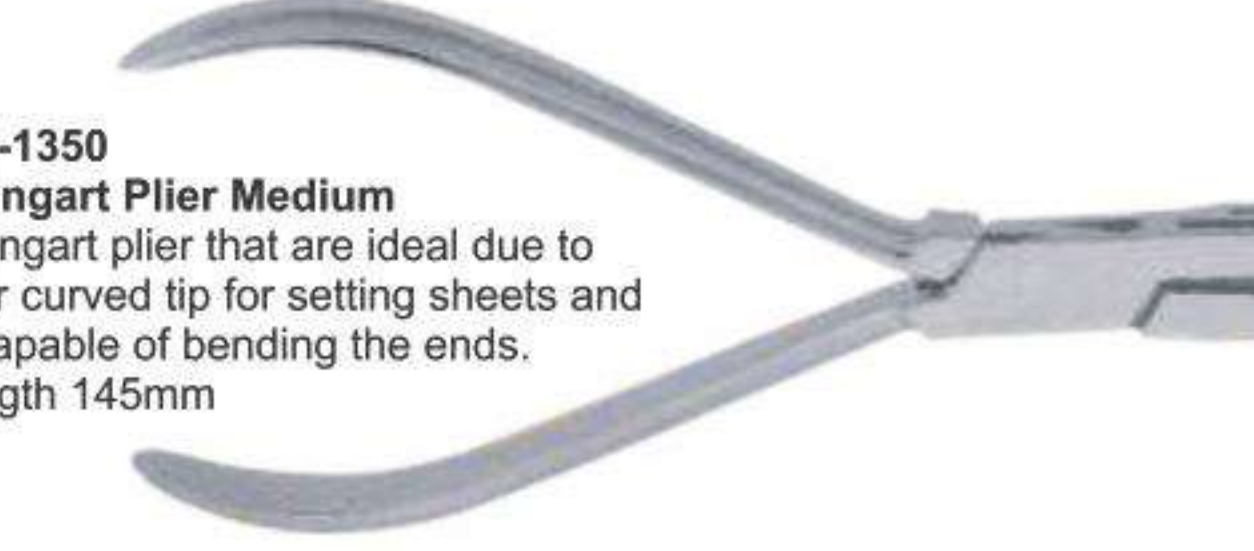

PLIERS FOR ORTHODONTICS & PROSTHETIE

■ Щипці для ортодонції та протезування
 ■ Pincers pour l'orthodontie et la prothèse
 ■ Zanger für Kieferorthopädie und Prothetik

■ Щипці для ортодонції та протезування
 ■ Alicates para ortodoncia y prótesis
 ■ كماشة لتقويم الأسنان بروسشيتيس

L-KEY JOINT PLIERS



786-1351
 Distal end cutter with safety hold mini head, long handles. fitted with un-breakable, corrosion resistant and durable stainless steel tips

- 0.30 mm to 0.50 mm (0.12" to .020")
- Max. 0.40 mm to 0.64 mm (0.18" x .025")
- ⊗ 0.38 mm to 0.53 mm (0.155" to .0215")
- ⊗ Max. 0.53 mm to 0.64 mm (0.21" x .025")



786-1355
 Soft wire and ligature cutter 15° angled fitted with un-breakable corrosion resistant and durable stainless steel tips

- ⌋ .25 mm to .38 mm (.010" to .015")



786-1352
 Flush-cut distal end cutter with safety hold fitted with un-breakable, corrosion resistant and durable stainless steel tips

- 0.30 mm to 0.50 mm (0.12" to .020")
- Max. 0.46 mm to 0.64 mm (0.18" x .025")



786-1356
 Soft wire and ligature cutter 45° angled fitted with un-breakable corrosion resistant and durable stainless steel tips

- ⌋ .25 mm to .38 mm (.010" to .015")



786-1353
 Soft wire and ligature cutter Mini fitted with un-breakable corrosion resistant and durable stainless steel tips

- ⌋ .25 mm to .38 mm (.010" to .015")



786-1357
 Hard wire cutter, straight fitted with un-breakable, corrosion resistant and durable stainless steel tips

- 0.30 mm to 0.50 mm (0.12" to .020")
- Max. 0.56 mm to 0.71 mm (0.22" x .028")



786-1354
 Soft wire and ligature cutter, standard fitted with un-breakable corrosion resistant and durable stainless steel tips

- ⌋ .25 mm to .38 mm (.010" to .015")



786-1358
 Hard wire cutter, 15° angled fitted with un-breakable, corrosion resistant and durable stainless steel tips

- 0.30 mm to 0.50 mm (0.12" to .020")
- Max. 0.56 mm to 0.71 mm (0.22" x .028")



786-1359
 Hard wire cutter, 15° angled Non-autocleavable

- 0.30 mm to 0.50 mm (0.12" to .020")
- Max. 0.56 mm to 0.71 mm (0.22" x .028")



PLIERS FOR ORTHODONTICS & PROSTHETICS

■ Щипцы для ортодонтии и протезирования
 ■ Pincers pour l'orthodontie et la prothèse
 ■ Zanger für Kieferorthopädie und Prothetik

■ Щипці для ортодонції та протезування
 ■ Alicates para ortodoncia y prótesis
 ■ كماشة لتقويم الأسنان بروسشیتیس

L-KEY JOINT PLIERS



786-1360
Band removing pliers



786-1365
Weingart-mini
Utility Pliers

● 0.30 mm to 0.50 mm (0.12" to .020")
 ■ Max. 0.56 mm to 0.71 mm (0.22" x .028")

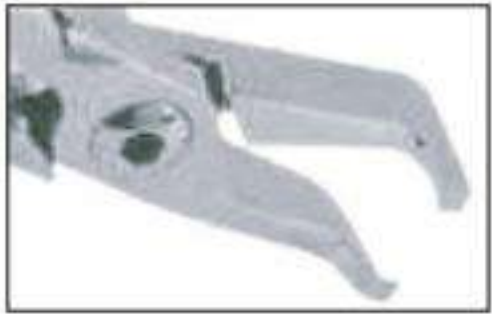

786-1361
Bracket removing
Pliers angled



786-1366
Weingart-mini
Utility Pliers

● 0.30 mm to 0.50 mm (0.12" to .020")
 ■ Max. 0.56 mm to 0.71 mm (0.22" x .028")



786-1362
Bracket removing pliers straight



786-1367
How Straight
Utility Pliers

● 0.30 mm to 0.50 mm (0.12" to .020")
 ■ Max. 0.56 mm to 0.71 mm (0.22" x .028")



786-1363
Bracket removing pliers with plastic tip



786-1368
Angled
Utility Pliers

● 0.30 mm to 0.50 mm (0.12" to .020")
 ■ Max. 0.56 mm to 0.71 mm (0.22" x .028")

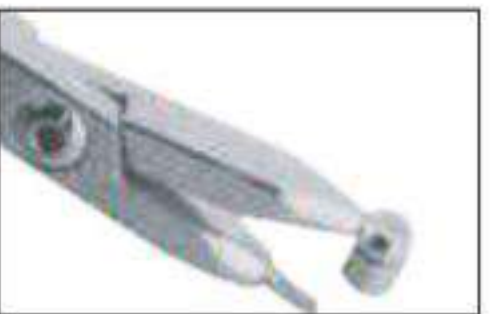

786-1364
Adhesive removing pliers



786-1369
Wire bending and loop forming pliers
Angled (Bird Beak)

● 0.30 mm to 0.50 mm (0.12" to .020")
 ■ Max. 0.56 mm to 0.71 mm (0.22" x .028")

PLIERS FOR ORTHODONTICS & PROSTHETIE

■ Щипцы для ортодонтии и протезирования
 ■ Pincers pour l'orthodontie et la prothèse
 ■ Zangen für Kieferorthopädie und Prothetik

■ Щипці для ортодонції та протезування
 ■ Alicates para ortodoncia y prótesis
 ■ كماشة لتقويم الأسنان بروتستيتيس

L-KEY JOINT PLIERS

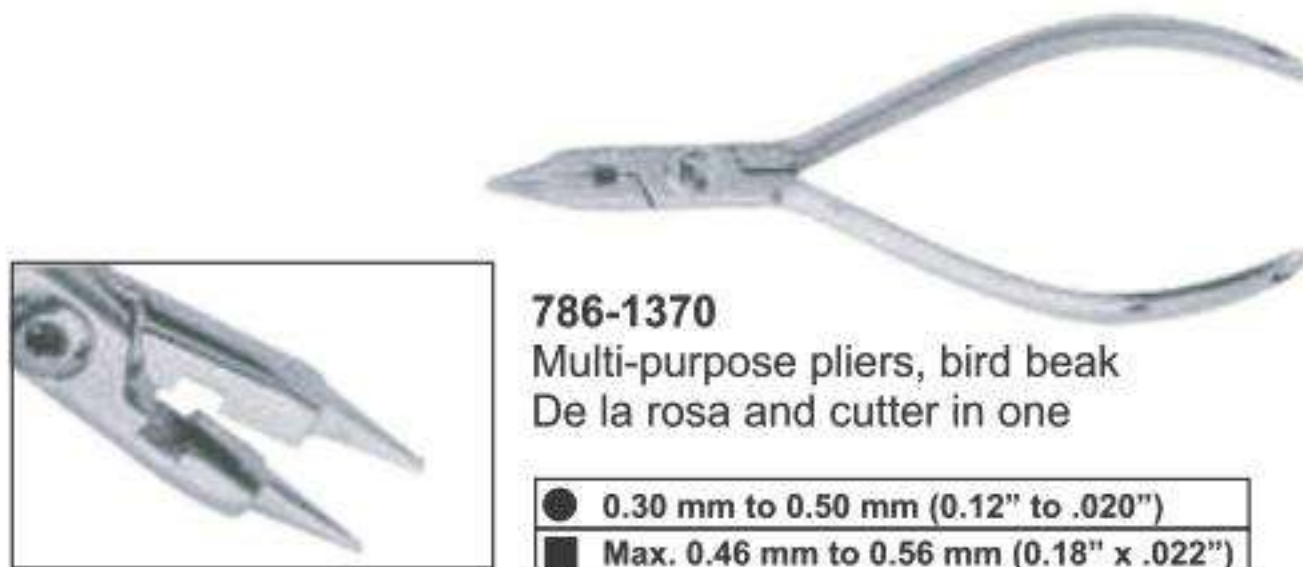

786-1370
 Multi-purpose pliers, bird beak
 De la rosa and cutter in one

● 0.30 mm to 0.50 mm (0.12" to .020")
 ■ Max. 0.46 mm to 0.56 mm (0.18" x .022")



786-1371
 Cinch Back / the back
 Distal end bending pliers

● 0.30 mm to 0.50 mm (0.12" to .020")
 ■ Max. 0.56 mm to 0.71 mm (0.22" x .028")



786-1372
 Hammer head
 Distal end bending pliers

● 0.30 mm to 0.50 mm (0.12" to .020")
 ■ Max. 0.56 mm to 0.71 mm (0.22" x .028")

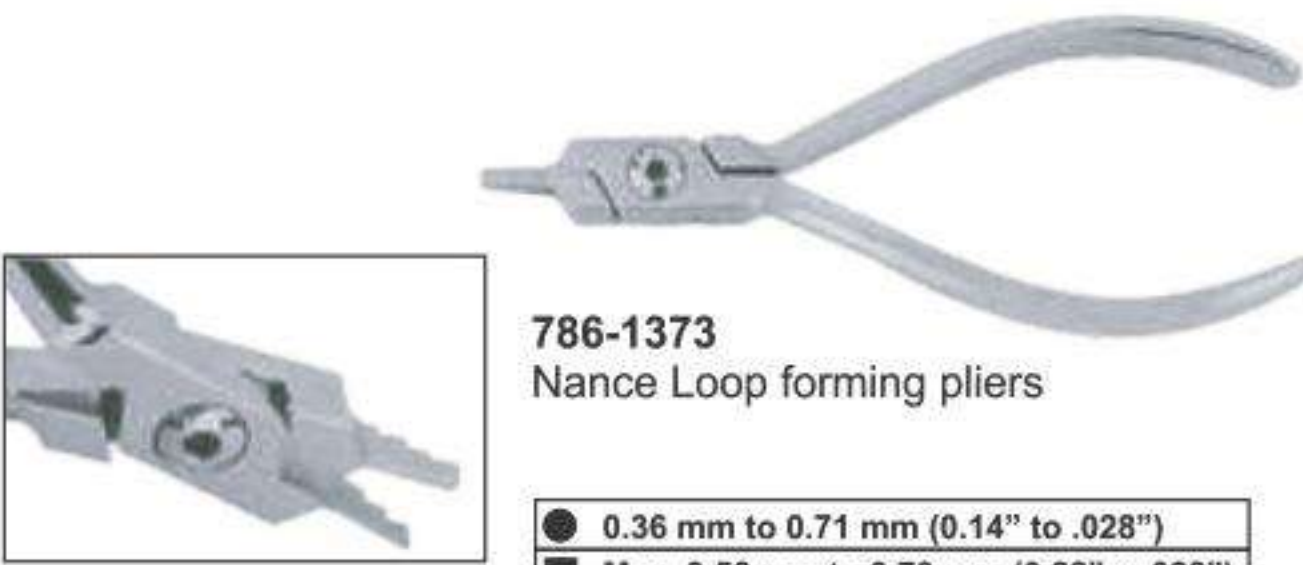

786-1373
 Nance Loop forming pliers

● 0.36 mm to 0.71 mm (0.14" to .028")
 ■ Max. 0.56 mm to 0.70 mm (0.22" x .028")



786-1374
 Detailing step pliers / Bayonet
 bending pliers - 1mm

● 0.30 mm to 0.50 mm (0.12" to .020")
 ■ Max. 0.56 mm to 0.71 mm (0.22" x .028")



786-1375
 Stop pliers V-Bebd - 1mm

● 0.30 mm to 0.50 mm (0.12" to .020")
 ■ Max. 0.56 mm to 0.71 mm (0.22" x .028")

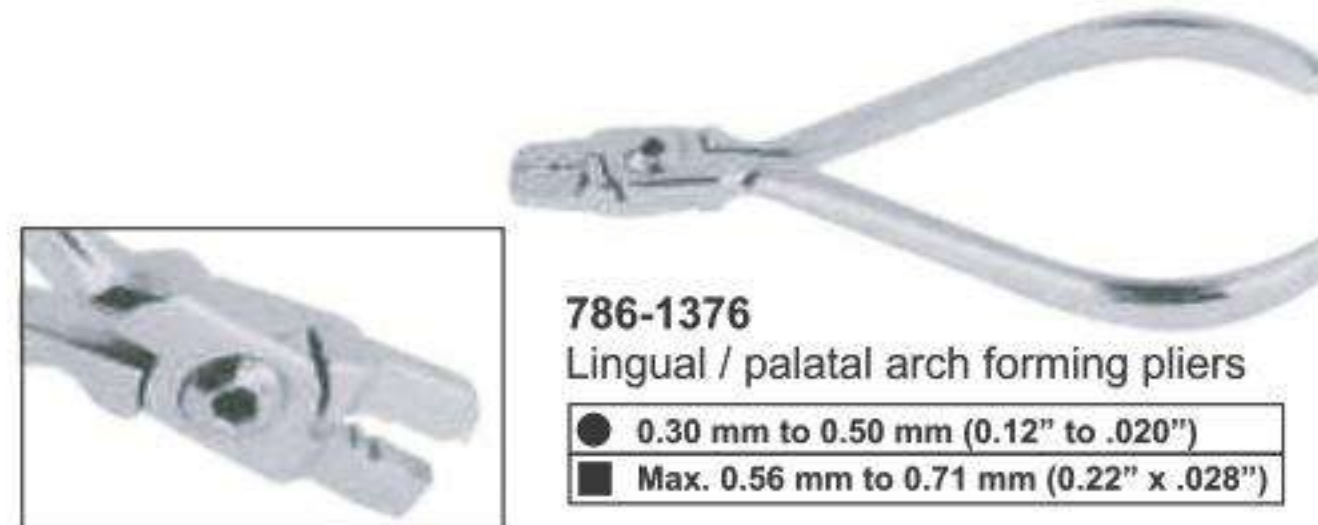

786-1376
 Lingual / palatal arch forming pliers

● 0.30 mm to 0.50 mm (0.12" to .020")
 ■ Max. 0.56 mm to 0.71 mm (0.22" x .028")



786-1377
 Torquing pliers set



786-1378
 Tweed / angled
 Rectangular arch forming and
 torquing pliers

● 0.30 mm to 0.71 mm (0.12" to .020")
 ■ Max. 0.56 mm to 0.71 mm (0.22" x .028")



786-1379
 Surgical ball hook crimping pliers
 angled



786-1380
 Surgical ball hook crimping pliers
 straight

PLIERS FOR ORTHODONTICS & PROSTHETICS

■ Щипці для ортодонції та протезування
 ■ Pincers pour l'orthodontie et la prothèse
 ■ Zanger für Kieferorthopadie und Prothetik

■ Щипці для ортодонції та протезування
 ■ Alicates para ortodoncia y prótesis
 ■ كمامة لتقويم الأسنان بروسشيتيس

L-KEY JOINT PLIERS

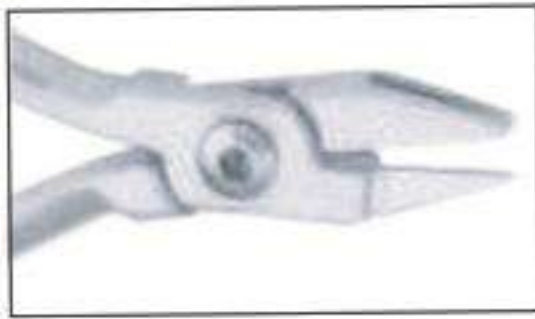

786-1381
 Aderer Clamp three jaw wire bending plier for contouring and bending wire up to 30" / 0.76mm



786-1387
 Falcon beak contouring pliers

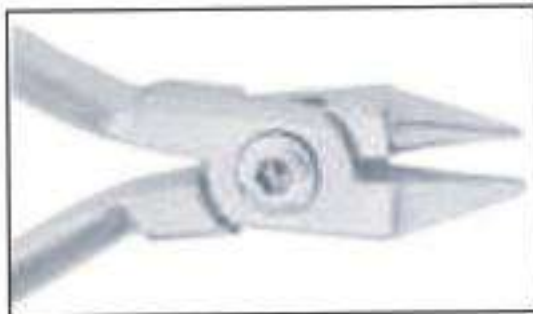
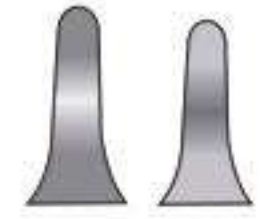

786-1382
 Bird beak plier for bending round square and rectangle wire up to 30" / .76mm

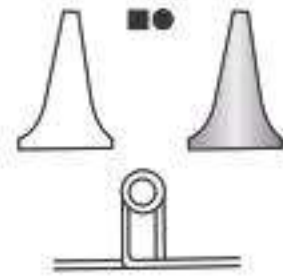

786-1388
 For placement and removal of arch wires, pins and other auxiliaries



786-1383
 Bird beak plier for light wire bending round square and rectangular up to .016" / 0.41mm

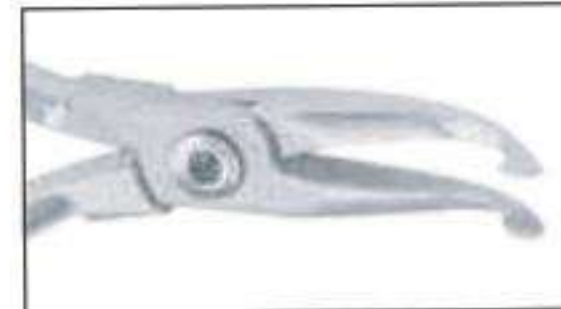
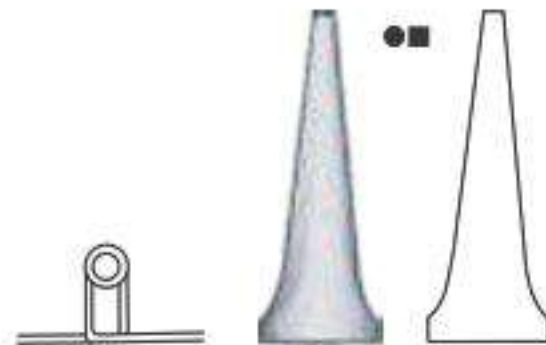

786-1389
 For placement and removal of arch wires, pins and other auxiliaries in angle design



786-1384
 Double Rounded jaw bending pliers hooks and wire up to .020" / 0.51mm

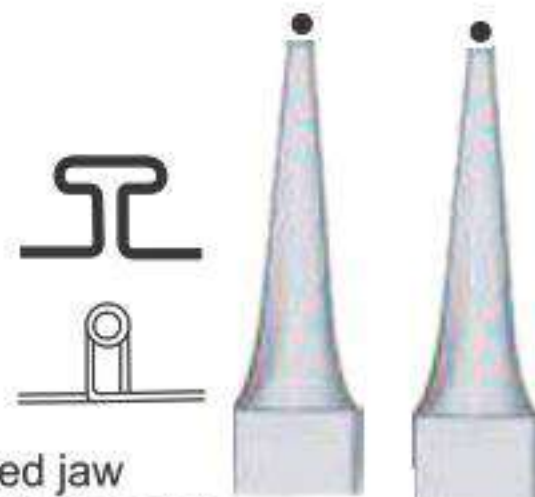

786-1390
 Contouring Plier



786-1391
 Bending plier, in order to skirt molaras bands, with grooved Recommended wire .016", .018" and .022" .041mm, 0.46mm and 0.56mm



786-1385
 Adams pliers to hooks and bending wire up to .030" / 0.76mm

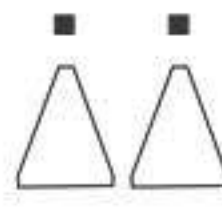

786-1392
 Long forming in four length 3,4,5, 7 6mm wire capacity 0.22 . 56mm

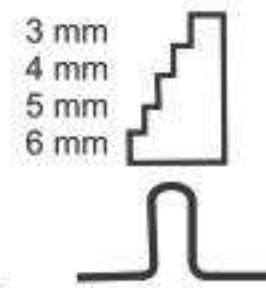

786-1386
 Johnson pliers for crown band contouring



786-1393
 Arch bending plier design for convenient handling of square or rectangular wire, 020" / 0.51mm



PLIERS FOR ORTHODONTICS & PROSTHETIE

■ Щипцы для ортодонтии и протезирования
 ■ Pincers pour l'orthodontie et la prothèse
 ■ Zanger für Kieferorthopadie und Prothetik

■ Щипці для ортодонції та протезування
 ■ Alicates para ortodoncia y prótesis
 ■ كماشة لتقويم الأسنان بروتھیتیس

LAP & L-KEY JOINT PLIERS



786-1394
 In order to skirt
 bands and crowns.



786-1395
 Wires up to
 .020" / 0.7mm

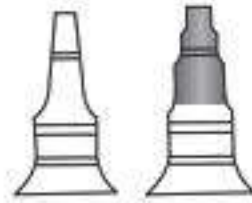

786-1396
 Round and concave plier
 for loop forming and bending
 wire up to .20" / .051mm

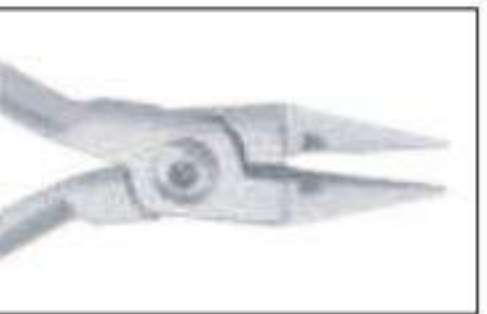

786-1397
 Bending for round square
 or rectangular wire up
 to 0.30" / 0.76mm

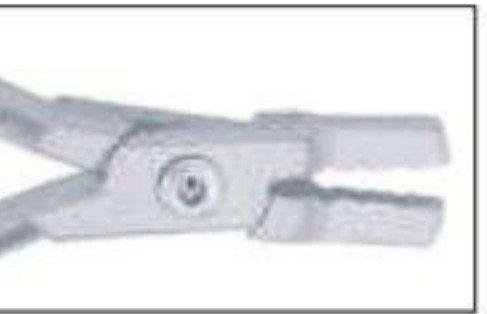

786-1398
 for double back and triple
 back bands in 0.30" / .76mm
 & .036" / .91mm lingual arch wires



786-1399
 Detailing step plier double sided
 offset beak permits bayonet bends.
 Creates right hand or left hand
 step-up or stepdown at 1/2", 3/4" or
 1mm increments.



786-1400
 "V" bend stop special design makes
 1mm "V" bends to shorten archwires
 or provide a positive stop Excellent
 for placing stop in titanium wires
 For round or rectangular wires up to .025"

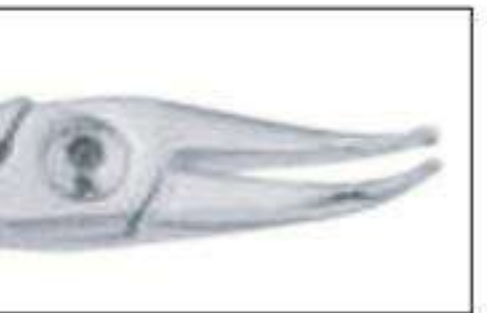

786-1401
 Angle how plier efficient utility plier
 with serrated beak for a firm grip
 45 angled tips to access hand or
 reach areas.



786-1402
 Weingardt plier serrated tips hold
 wires firmly at a convenient working
 angle tapered beak fit easily
 between brackets and hard to reach
 areas, Our most popular utility plier



786-1415
 Pin 8 Ligature Cutter
 TC



786-1416
 Mini Pin 8 Ligature
 Cutter TC



786-1417
 Standard Ligature
 Cutter TC



786-1418
 V Band Stop Plier
 TC.



786-1419
 Angled Direct Bond Bracket
 Remover TC

ISTAL END, WIRE CUTTER & BRACKET REMOVER PLIERS

786-1420
Distal end Cutter Safety hold Plier
(Ideal for Cutting Wire) TC



786-1421
Hook Crimping Plier Angled
Straight TC



786-1422
3 Prong Clasp Adjustable
Plier TC



786-1423
Utility Plier Weingart TC



786-1424
Diret Bracket Remover
TC



786-1425
Straight Direct Bond Bracket
Remover TC



786-1426
Pin Holding Plier TC



786-1427
Hard wire cutter



786-1428
Elastic Separating Plier
Round Handle



786-1429
Elastic Separating Plier



786-1430
786-1431
Smaha
Elastomeric
ligature
placing forceps
140mm



786-1432
Elastomeric
ligature placing
forceps with
groove
Falcon 140mm

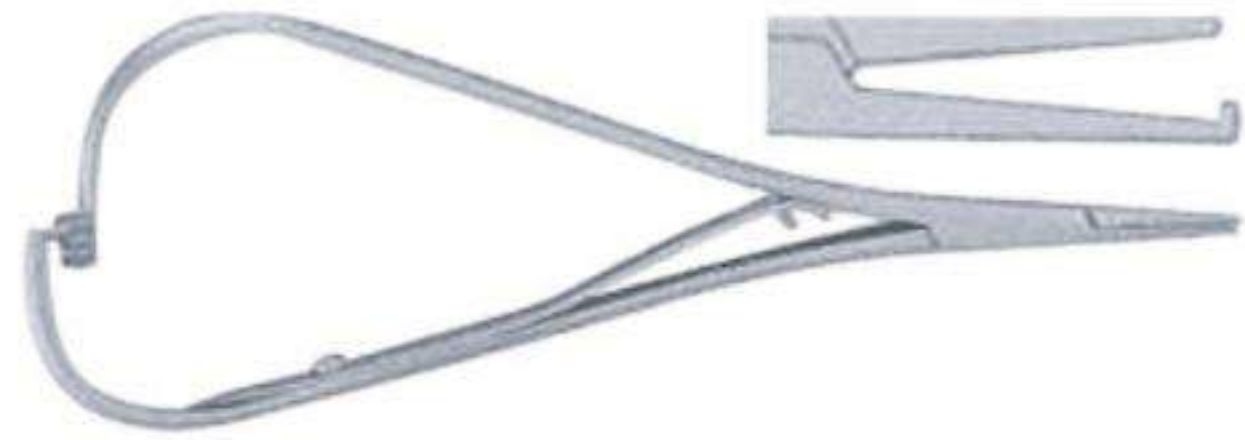

786-1433
Elastomeric
ligature placing
forceps with
groove
Falcon 140mm

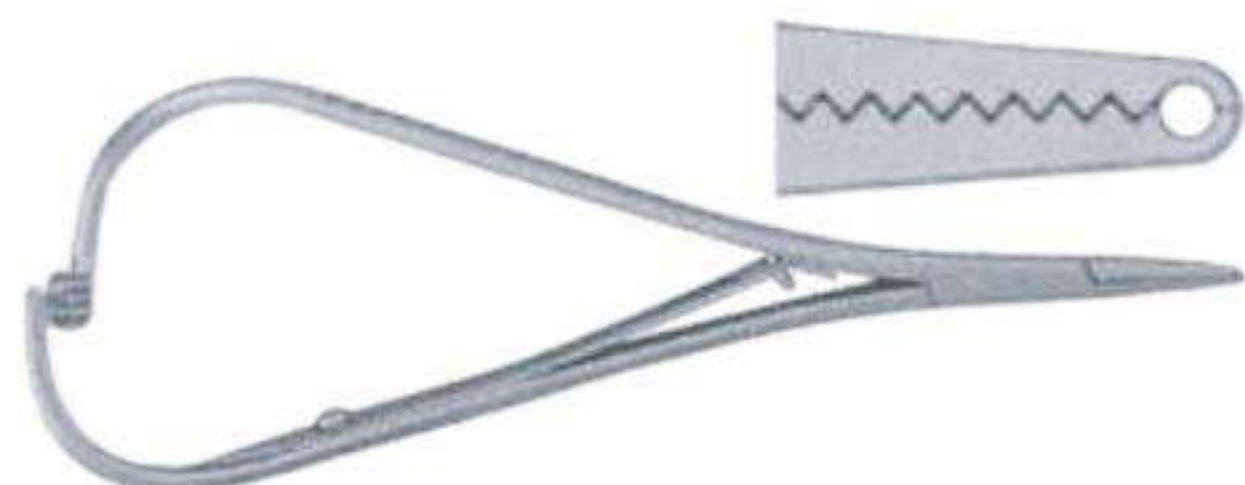

DENTAL IMPLANT INSTRUMENTS

Normal Anatomy – Dental Implants

Bone Level Normal
(No Bone Loss)



Maxillary Sinus

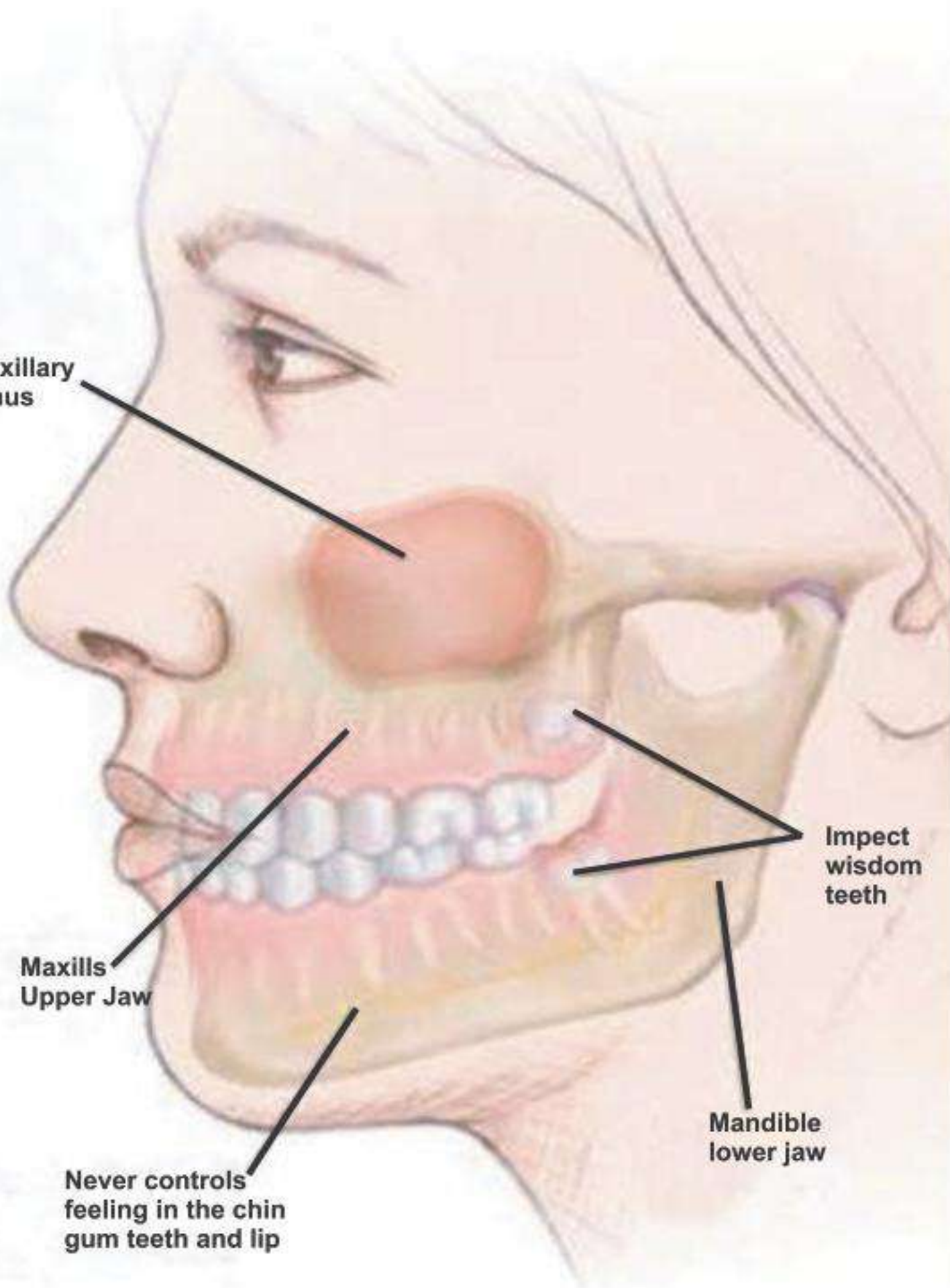

Maxilla
Upper Jaw

Impacted
wisdom
teeth

Mandible
lower jaw

Never controls
feeling in the chin
gum teeth and lip

■ Инструменты для имплантологии
 ■ Implantologie
 ■ Implantologie

■ Инструменти для імплантології
 ■ Implantologia
 ■ زراعة الأسنان

IMPLANT GAGES



786-1434
Multifunctional Meter
 Length 90 mm
 different sizes,
 8-10-11mm,
 corrosion-resistant

786-1435
Multifunctional Meter
 Length 90 mm
 different sizes,
 5-13-15-17mm,
 corrosion-resistant

786-1436
Measuring Probe
 Length 170 mm
 hand shape or flexible
 (6-8-10-14-16 mm)
 corrosion-resistant

786-1437

786-1438

786-1439

786-1440

IMPLANT GAGES



786-1441

786-1442

786-1443

IMPLANTOLOGY

■ Инструменты для имплантологии
 ■ Implantologie
 ■ Implantologie

■ Инструменти для имплантології
 ■ Implantoloia
 ■ زراعة الأسنان



786-1444
Clamp, Osteometer
 Length about 155 mm
 ridge width measurement
 two sided scale
 measuring
 range 0-25 mm



786-1445
Measuring Loop
 straight length 90 mm
 measuring range
 0-40 mm



786-1446
Measuring Loop
 angled length 90 mm
 measuring range
 0-40 mm



786-1447
Measuring Loop Castroviejo
 angled length 175 mm
 measuring range 0-40 mm
 with window



786-1448
Boley Gauge
 Stainless Steel



786-1449
Measuring Loop
 angled length
 175 mm
 measuring range
 0-40 mm



786-1450
Measuring Loop
 straight length
 175 mm
 measuring range
 0-40 mm



786-1451
Fig.1
 Iwanson
 spring caliper
 For metal and
 porcelain



786-1452
Fig. 2
 Iwanson
 spring caliper
 For wax



786-1453
Bone Thickness Gauge
 40mm, 180mm



786-1454
Gauge
 for measuring
 distances
 (0.90 mm)

IMPLANTOLOGY

■ Инструменты для имплантологии
■ Implantologie
■ Implantologie

■ Инструменти для имплантології
■ Implantologia
■ زراعة الأسنان

BLACK TITANIUM COLOUR COATED INSTRUMENTS

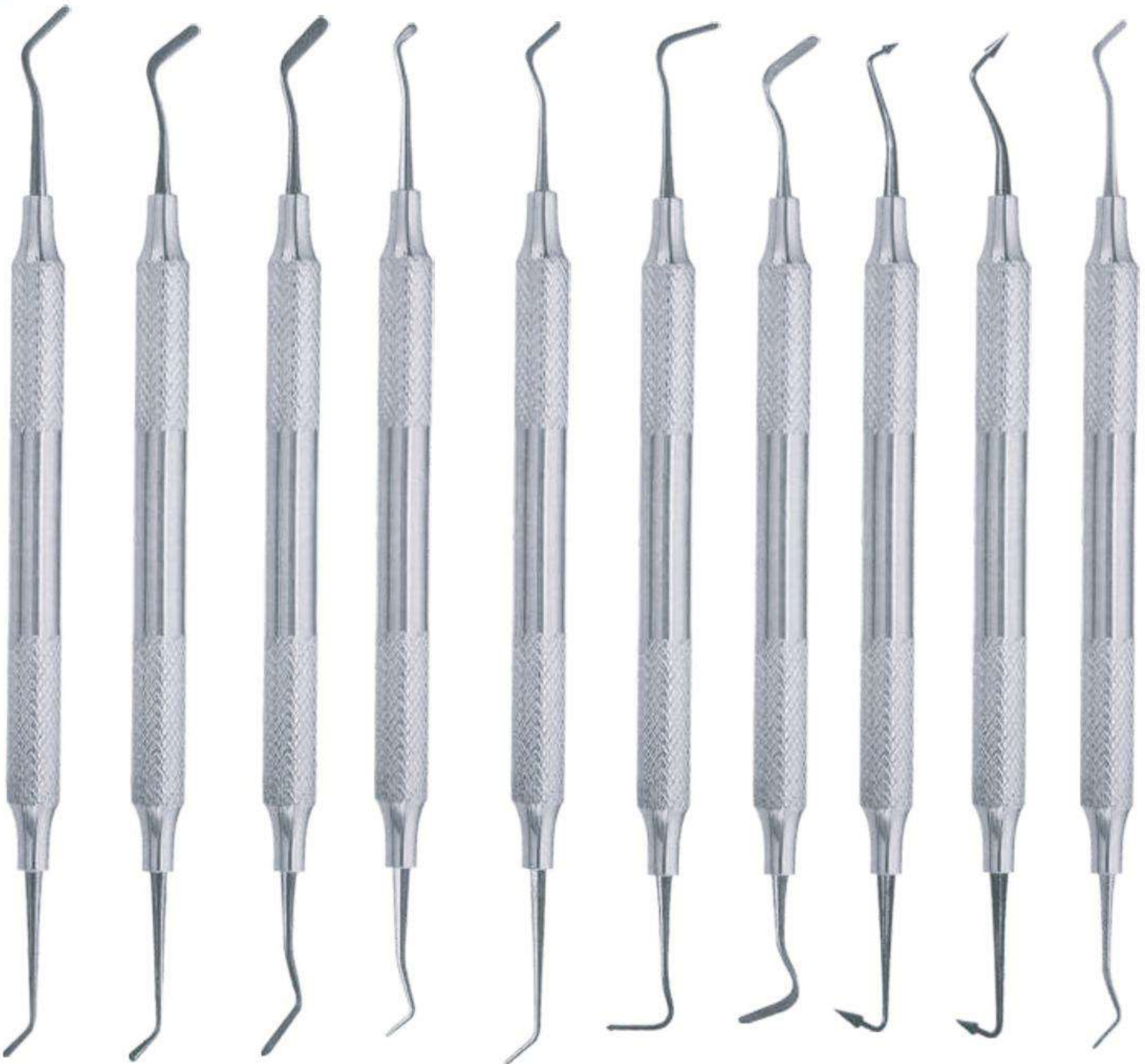

786-1455
#1

786-1456
#2

786-1457
#3
Extra-Flex

786-1458
Micro-Mini

786-1459
Mini 1

786-1460
Mini 4
Extra-Flex

786-1461
#4
Extra-Flex

786-1462
#5
Flexi-Thin

786-1463
#6
Flexi-Thin

786-1464
Mini 3
Extra-Flex

IMPLANTOLOGY

■ Инструменты для имплантологии
■ Implantologie
■ Implantologie

■ Инструменти для имплантології
■ Implantologia
■ زراعة الأسنان

BLACK TITANIUM COLOUR COATED INSTRUMENTS

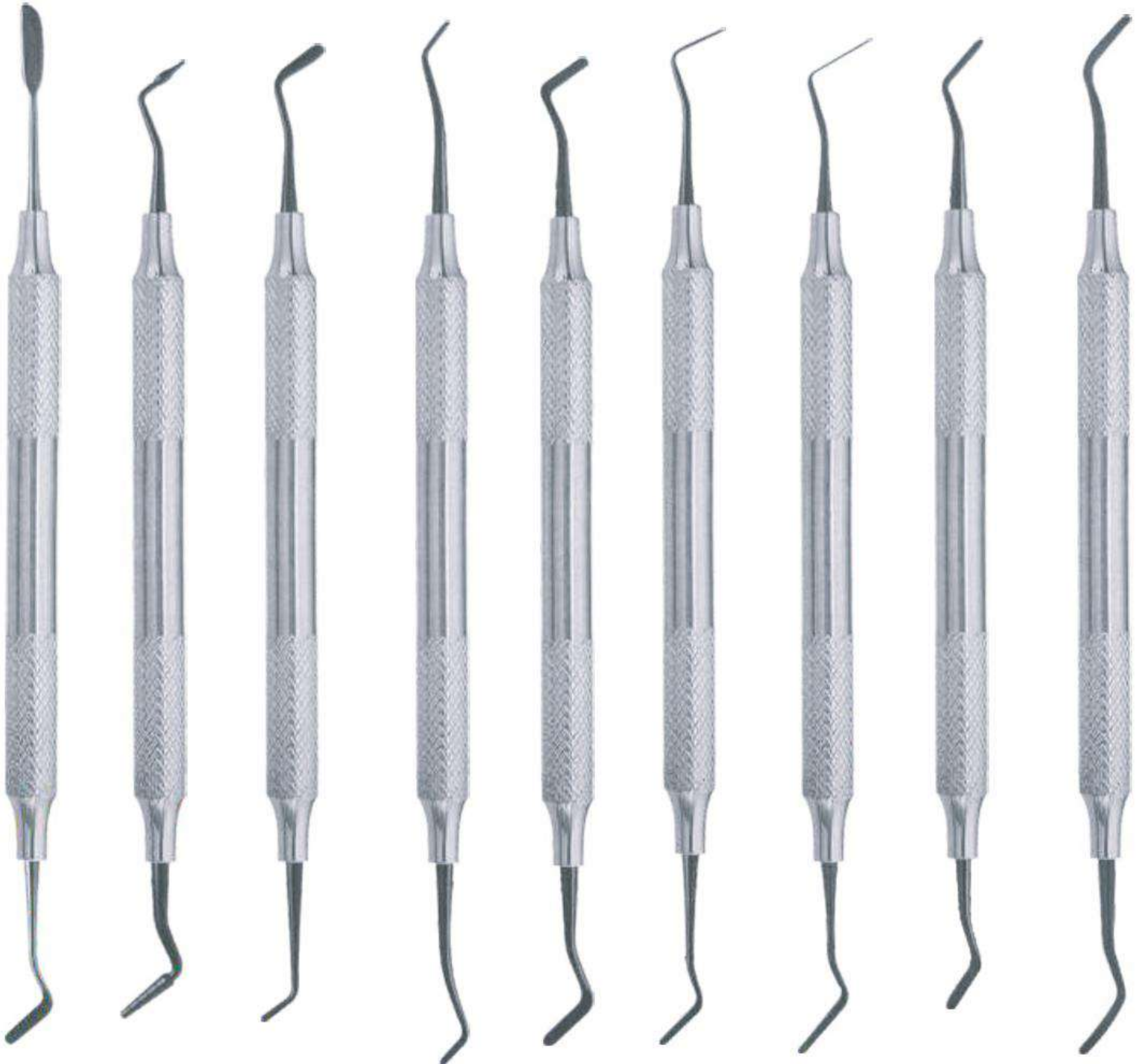

786-1465
AB1
Boghosian

786-1466
AB2
Boghosian

786-1467
W3

786-1468
8A

786-1469
4/5
Gregg

786-1470
Interproximal
Carver

786-1471
Interproximal
Carver, Longe

786-1472
A6

786-1473
Contouring
Instrument

■ Инструменты для имплантологии
■ Implantologie
■ Implantologie

■ Инструменти для имплантології
■ Implantologia
■ زراعة الأسنان

BLACK TITANIUM COLOUR COATED INSTRUMENTS

BURNISHERS

FREEDMAN BURNISHERS

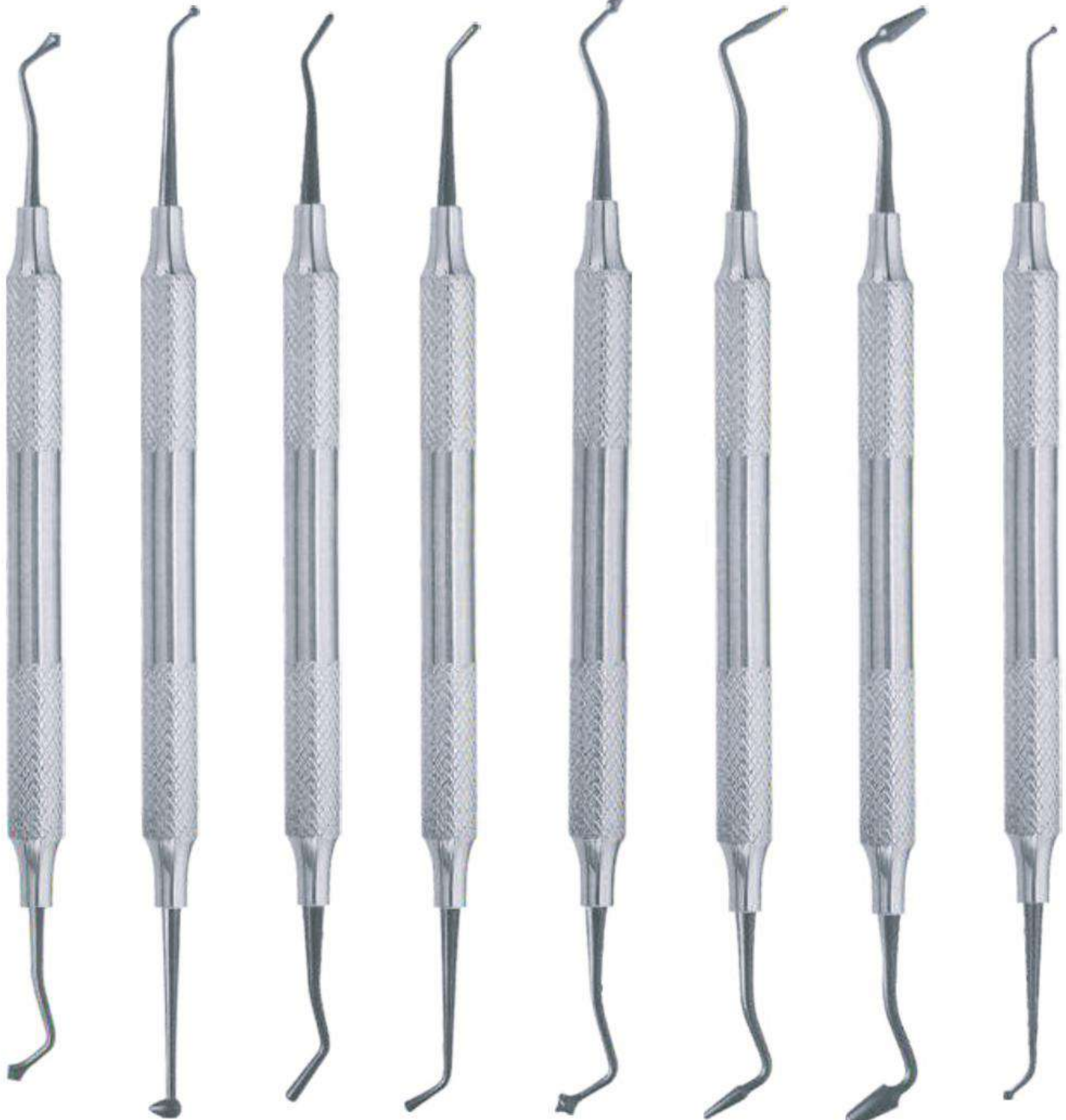

786-1474
21B

786-1475
27/29

786-1476
2
Ladmore

786-1477
3
Ladmore

786-1478
Freedman
"Duckhead"

786-1479
Freedman
Small Contact
Forming

786-1480
Freedman
Large Contact
Forming

786-1481
Small/
Medium Ball
Burnisher

IMPLANTOLOGY

■ Инструменты для имплантологии
■ Implantologie
■ Implantologie

■ Инструменти для имплантології
■ Implantologia
■ زراعة الأسنان

BLACK TITANIUM COLOUR COATED INSTRUMENTS

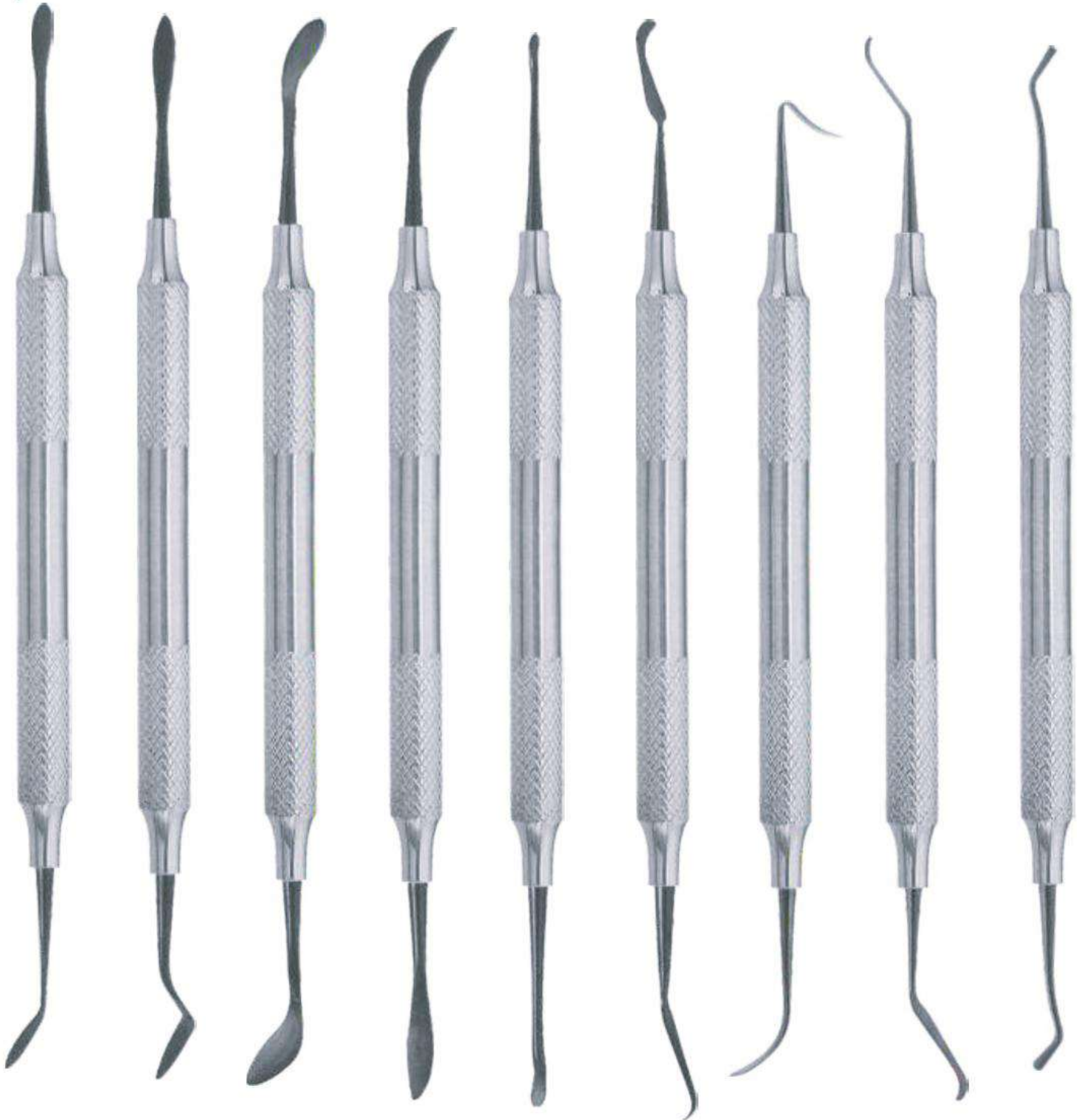

786-1482
A
Cosmetic
Contouring

786-1483
B
Cosmetic
Contouring

786-1484
C
Cosmetic
Contouring

786-1485
D
Cosmetic
Contouring

786-1486
E
Cosmetic
Contouring

786-1487
F
Cosmetic
Contouring

786-1488
Marginal Ridge
& Embrasure
Shaping Inst

786-1489
Occlusal
Anatomy
Instrument

786-1490
Composite
Packing
Instrument

IMPLANTOLOGY

■ Инструменты для имплантологии
■ Implantologie
■ Implantologie

■ Инструменти для имплантології
■ Implantologia
■ زراعة الأسنان

BLACK TITANIUM COLOUR COATED INSTRUMENTS

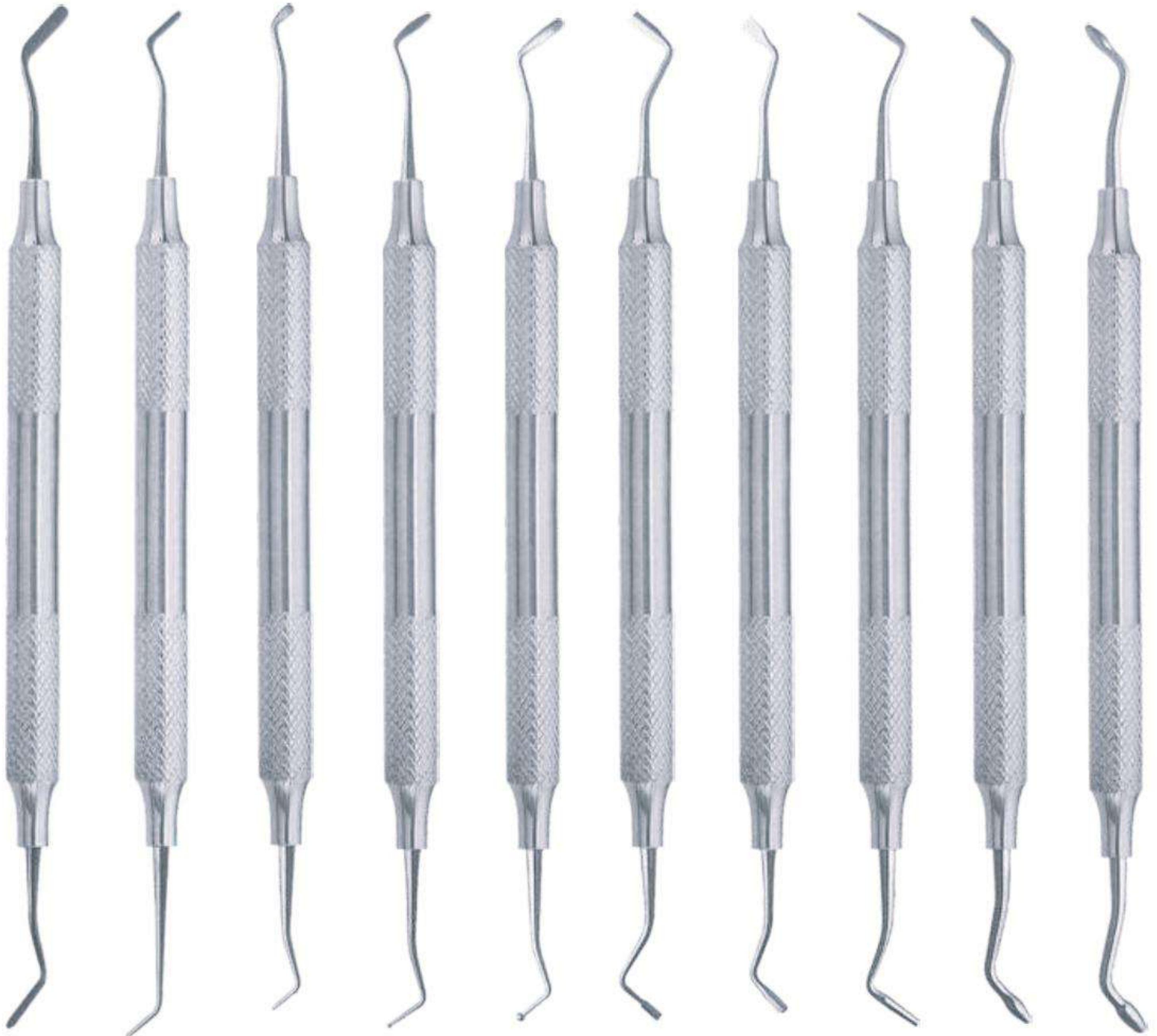

786-1491
#3
Extra-Flex

786-1492
Mini 1

786-1493
Micro-Mini

786-1494
Medium
Placing/
Condensing

786-1495
Large
Placing/
Condensing

786-1496
0T
Tanner

786-1497
3
Hollenback

786-1498
5A

786-1499
Small/Medium
Contact
Forming

786-1500
Medium/Large
Contact
Forming

IMPLANTOLOGY

■ Инструменты для имплантологии
■ Implantologie
■ Implantologie

■ Instrumenti для имплантології
■ Implantologia
■ زراعة الأسنان

SINUS LIFT INSTRUMENTS HOLLOW HANDLE 9.5MM LENGTH 170MM

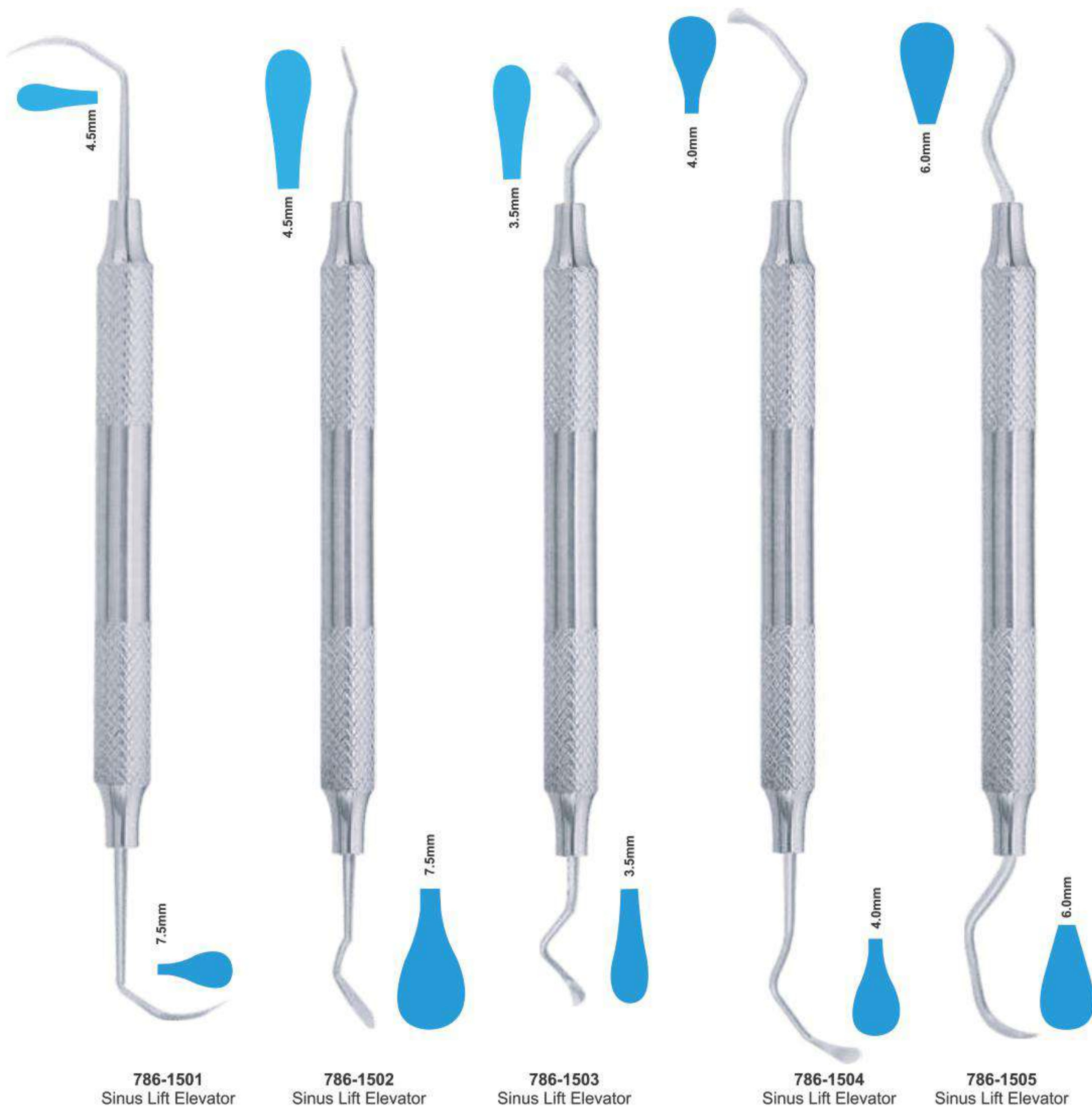

786-1501
Sinus Lift Elevator

786-1502
Sinus Lift Elevator

786-1503
Sinus Lift Elevator

786-1504
Sinus Lift Elevator

786-1505
Sinus Lift Elevator

■ Инструменты для имплантологии
■ Implantologie
■ Implantologie

■ Инструменти для имплантології
■ Implantologia
■ زراعة الأسنان

SINUS LIFT INSTRUMENTS HOLLOW HANDLE 9.5MM LENGTH 170MM



786-1506
Sinus Lift Elevator



786-1507
Sinus Lift Elevator



786-1508
Sinus Lift Elevator



786-1509
Sinus Lift Elevator

IMPLANTOLOGY

■ Инструменты для имплантологии
■ Implantologie
■ Implantologie

■ Инструменти для имплантології
■ Implantologia
■ زراعة الأسنان

IMPLANT SINUS LIFT INSTRUMENTD HOLLOW HANDLE 9.5MM LENGHT 170MM

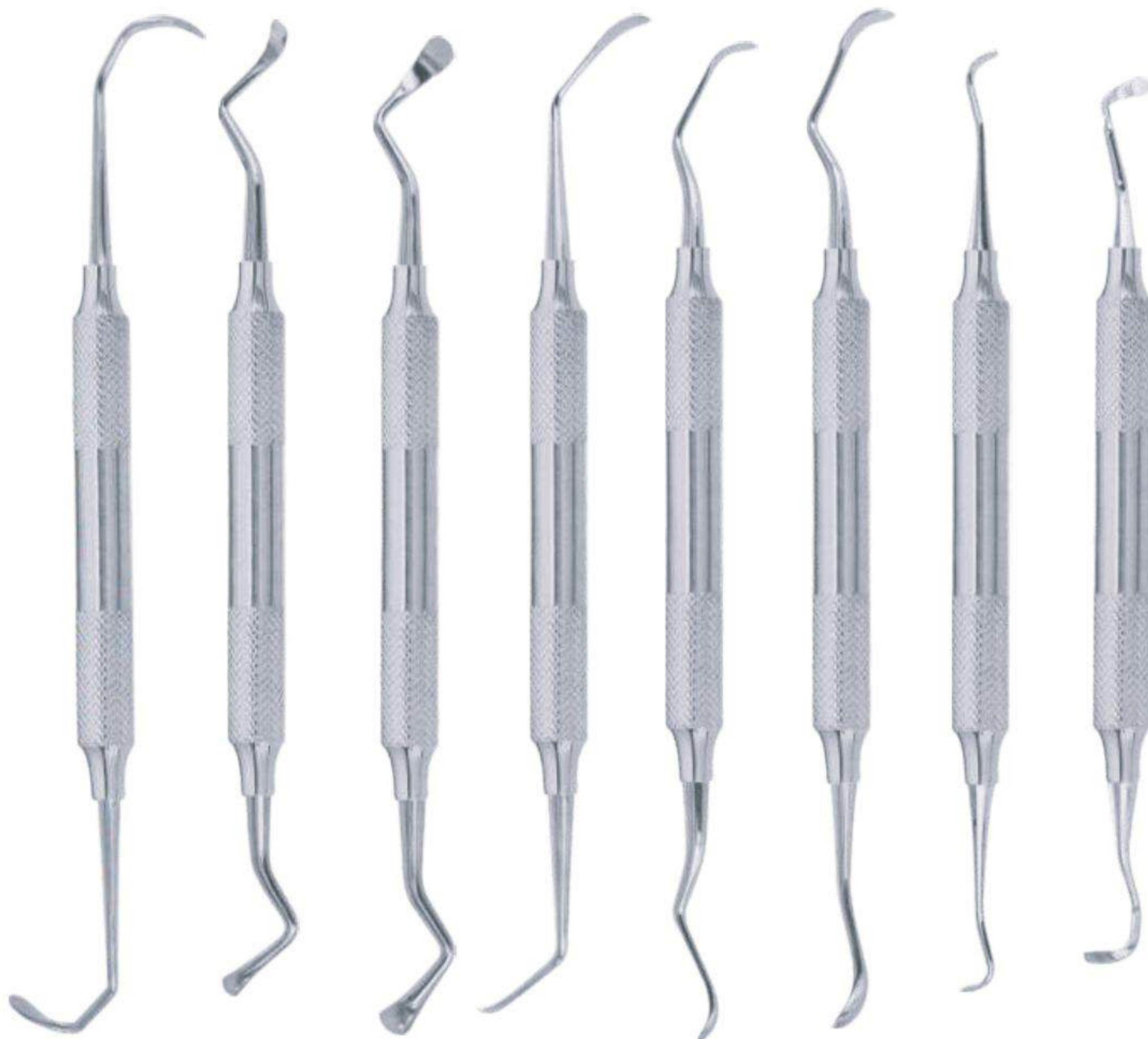

786-1510
Acute 6577

786-1511
Sinus 1

786-1512
Sinus 2

786-1513
Sinus 3
Obtuse 6578

786-1514
Sinus 4

786-1515
Sinus 5

786-1516
Sinus 6

786-1517
Sinus 7

IMPLANTOLOGY

■ Инструменты для имплантологии
■ Implantologie
■ Implantologie

■ Инструменти для имплантології
■ Implantologia
■ زراعة الأسنان

SINUS LIFT INSTRUMENTS HOLLOW HANDLE 9.5MM LENGTH 170MM

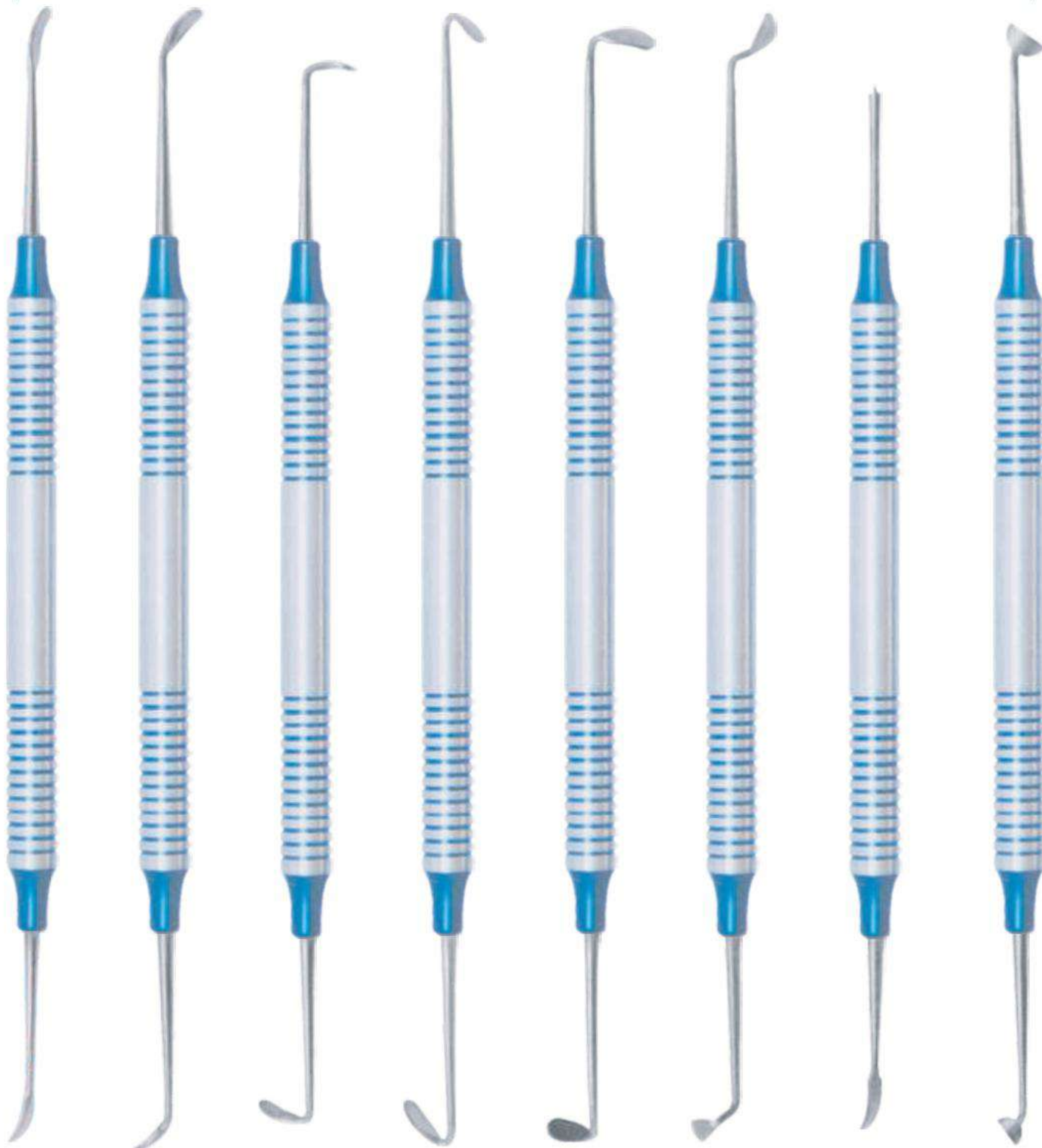

786-1518
Sinus Lift 1

786-1519
Sinus Lift 2

786-1520
Sinus Lift 3

786-1521
Sinus Lift 4

786-1522
Sinus Lift 5

786-1523
Sinus Lift 6

786-1524
Membrane
3Positioning

786-1525
Condenser 1

IMPLANTOLOGY

- Инструменты для имплантологии
- Implantologie
- Implantologie

- Инструменти для имплантології
- Implantologia
- زراعة الأسنان

Sinus Lift Instruments

Flexible Sinus Lift instruments reduce the risk of perforation of the "Schneider's membrane"



786-1526
Fig. 1

786-1527
Fig. 2

786-1528
Fig. 3

Sinus Lift Elevator

10 mm Straight grip
Length 175 mm, Sinus lift elevators, dull for gentle peeling and lifting the "Schneider's membrane"



786-1529
Fig. 1

786-1530
Fig. 2

786-1531
Fig. 3

Sinus Lift Instrument

10 mm Straight grip Length 180 mm, Buser (B1, B2, B3) raspations, quality medical stainless steel, corrosion-resistant



786-1532
B01

786-1533
B02

786-1534
Fig. B03

■ Инструменты для имплантологии
■ Implantologie
■ Implantologie

■ Инструменти для имплантології
■ Implantologia
■ زراعة الأسنان

Sinus Lift Instrument 10 mm Striaght grip Sinus lift elevators, blunt or sharply curved (H01, H02, K03, K04, K78, K77)

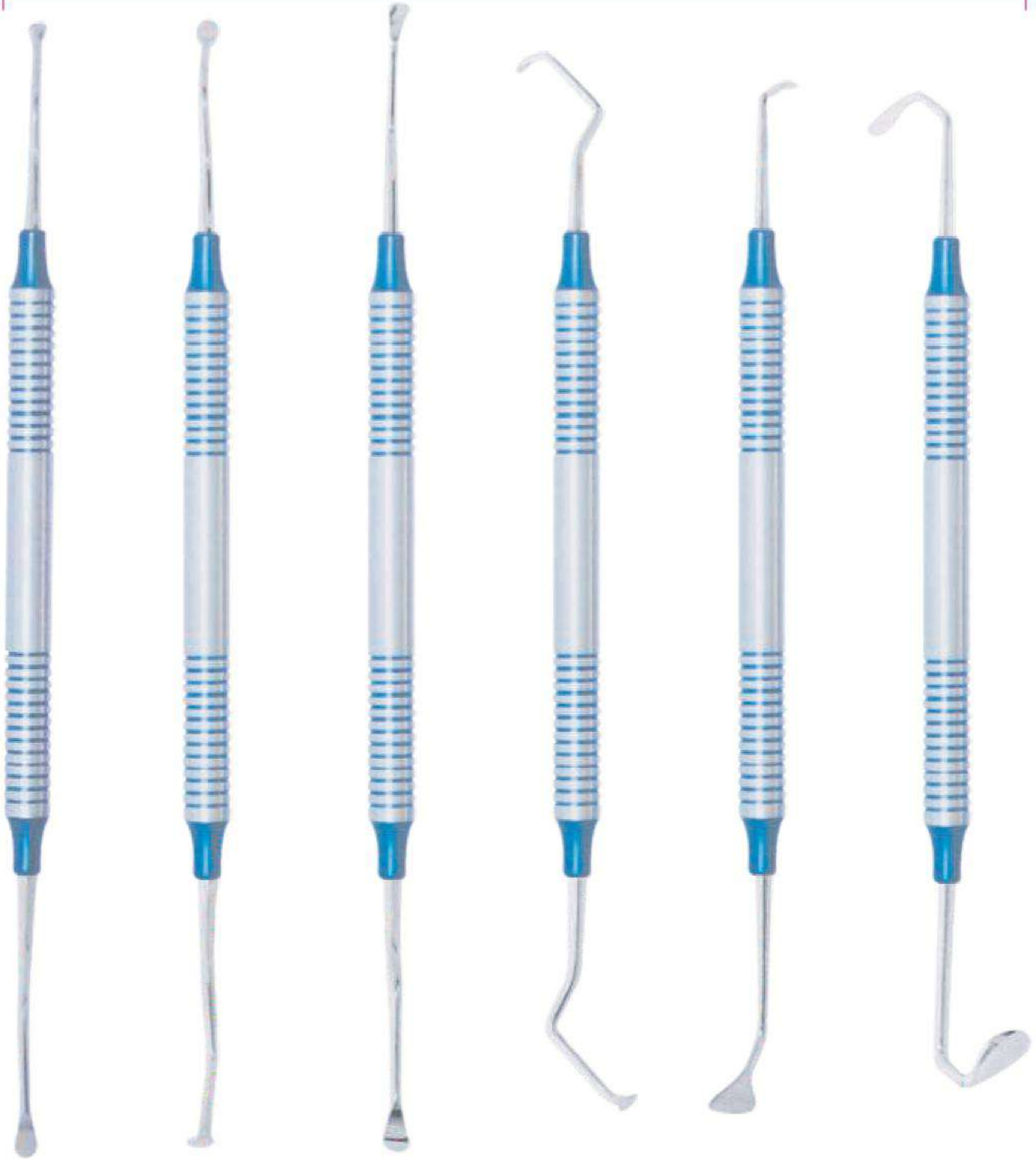

786-1535
Sinus lift instrument
H01

786-1536
Sinus lift instrument
H02

786-1537
Sinus lift instrument
K03

786-1538
Sinus lift
instrument
K04

786-1539
Sinus lift
instrument
K78

786-1540
Sinus lift
instrument
K77

IMPLANTOLOGY

■ Инструменты для имплантологии
■ Implantologie
■ Implantologie

■ Instrumenti для имплантології
■ Implantologia
■ زراعة الأسنان

SINUS LIFT INSTRUMENTS

Sinus Lift Elevators, 10 mm Hollow Handle Length 170mm Blunt Curved Set of 6 Pcs

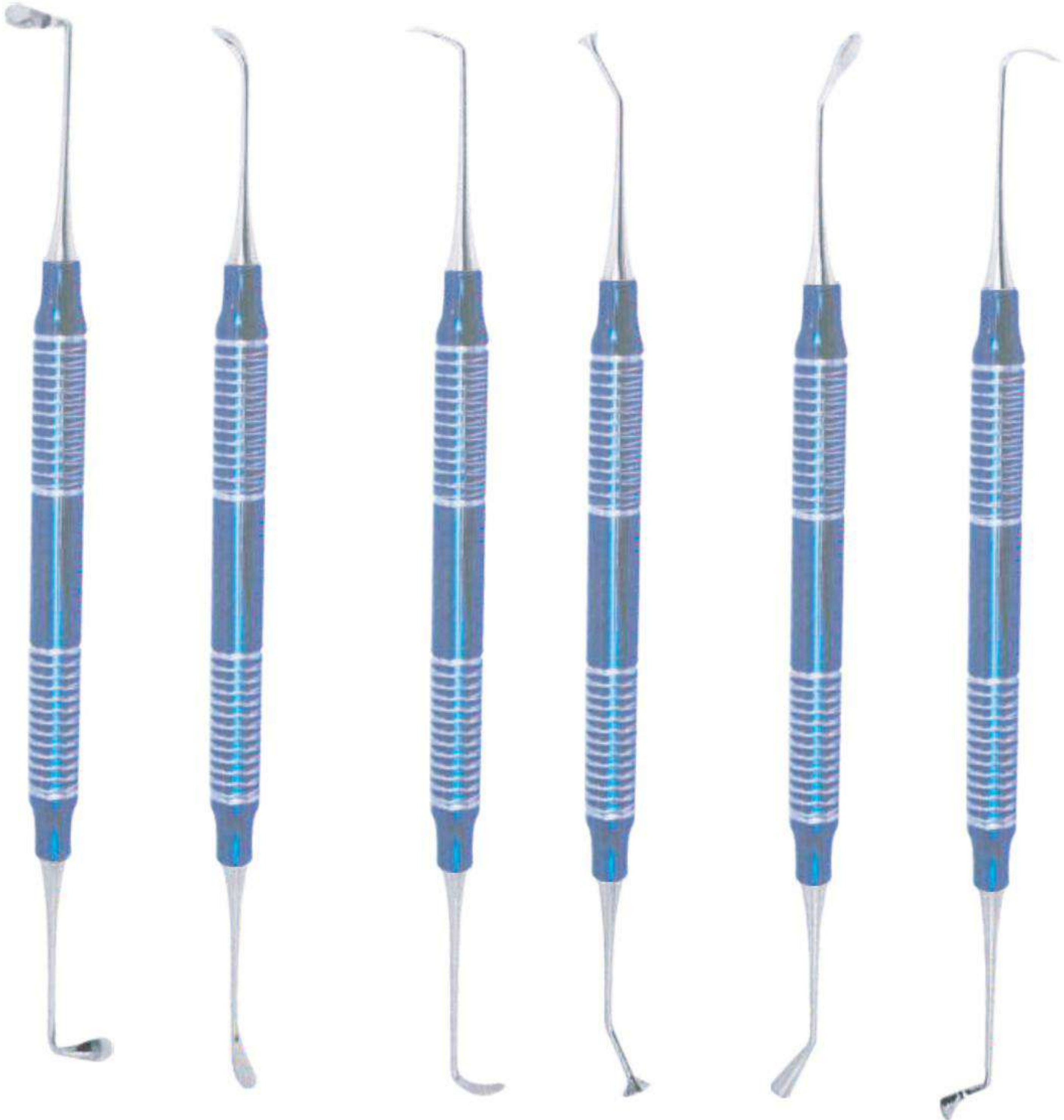

786-1541

786-1542

786-1543

786-1544

786-1545

786-1546

IMPLANTOLOGY

■ Инструменты для имплантологии
■ Implantologie
■ Implantologie

■ Инструменти для имплантології
■ Implantologia
■ زراعة الأسنان

IMPLANT SINUS LIFT INSTRUMENTS PERIODONTAL SURGERY SURGICAL CHISELS KRAMER NEVINS SINUS LIFT



786-1547 TG



786-1548 SOLT 3/4



786-1549 TGO



2786-1550 29K



786-1551 FEDI4



786-1552 OCH3



786-1553 OCH4



786-1554 FEDI1



786-1555 FEDI2



786-1556 FEDI3



786-1557 Gf36

IMPLANTOLOGY

■ Инструменты для имплантологии
■ Implantologie
■ Implantologie

■ Инструменти для имплантології
■ Implantologia
■ زراعة الأسنان

IMPLANT

SURGICAL CHISELS



■ Инструменты для имплантологии
 ■ Implantologie
 ■ Implantologie

■ Инструменти для имплантології
 ■ Implantologia
 ■ زراعة الأسنان

MIXING SPATULA WITH SHOVEL



786-1568
 Bone Carrier
 Titanium



786-1569
 Raspator, Prichard
 Length 180 mm
 10 mm hollow handle,
 double-ended
 10.5mm | 4.5mm



786-1570
 Raspator, Prichard
 Length 180 mm
 10 mm hollow handle,
 double-ended



786-1571
 Raspator, Prichard
 Length 180 mm
 10 mm hollow handle,
 double-ended
 10.5mm | 4.5mm



786-1572
 Mixing Spatula
 with shovel
 17cm



786-1573
 Mixing Spatula
 with shovel
 18.5cm

IMPLANTOLOGY

■ Инструменты для имплантологии
 ■ Implantologie
 ■ Implantologie

■ Инструменти для имплантології
 ■ Implantologia
 ■ زراعة الأسنان

BONE GRAFTING INSTRUMENTS COMPACTOR/TAMPERS

Product offering includes instruments for harvesting, mixing and compacting bone Provides clinicians with the proper instrumentation for bone grafting procedures Weighted bone basin Prevents tipping and spilling of bone and other materials during mixing

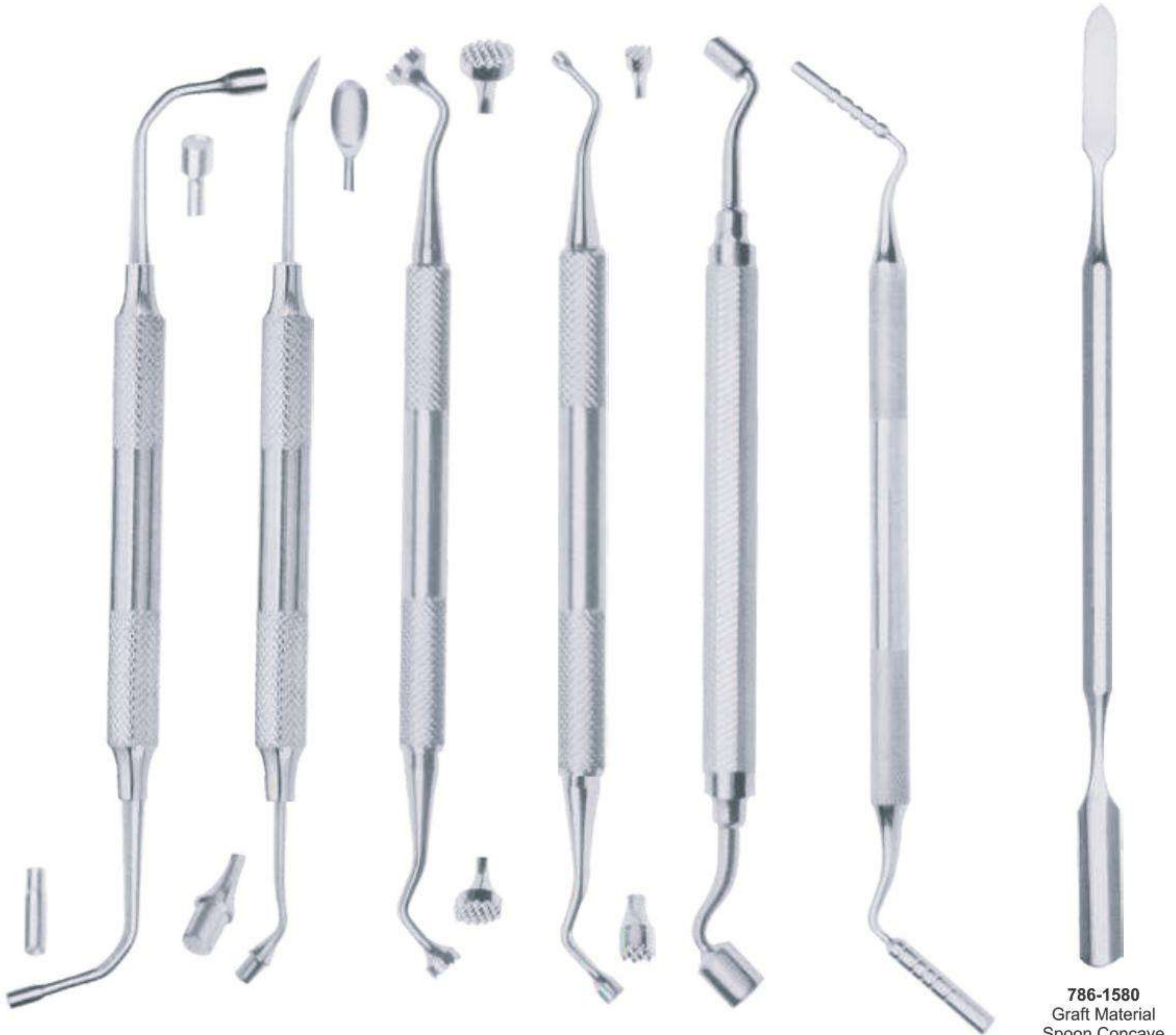

786-1574
 Graft Packer,
 Convave Tips
 DE 4/6mm

786-1575
 Bone Spoon/
 Packer DE 3mm

786-1576
 Graft Packer,
 Serrated Tips
 DE 6/8mm

786-1577
 Graft Packer,
 Serrated Tips
 DE 3/4mm

786-1578
 Graft Packer,
 Smooth Tipe
 DE 5/8mm

786-1579
 Titanium graft packer
 placement site depth
 gauge 3.3mm & 4.0mm
 Diameter tips Marked
 at 8, 11, 13, 16 & 18mm

786-1580
 Graft Material
 Spoon Concave
 Tip For
 Larger Grafts

■ Инструменты для имплантологии
 ■ Implantologie
 ■ Implantologie

■ Инструменти для имплантології
 ■ Implantologia
 ■ زراعة الأسنان

BONE GRAFTING INSTRUMENTS



786-1581
Blade and Pusher
 Length 180mm,
 for straight or angled
 blade, 15 x 5mm,
 pusher 4mm diameter
 Straight



786-1582
Blade and Pusher
 Length 180mm,
 for straight or angled
 blade, 15 x 5mm,
 pusher 4mm diameter
 angular



786-1583
Spoon and Pusher
 Length 180mm,
 for angled spoon
 10 x 5mm pusher
 diameter 3mm



786-1584
Tunnelierungs
Instruments
 Length 175mm,



786-1585
Tunnelierungs
Instruments
 Length 175mm,
 diameter designs



786-1586
Tamper
 Length 170mm,
 for bone material
 double ended,
 diameter 3.2 mm
 (2-4-6-8-10) and diameter
 2.5mm (2-4-6-8-10)

IMPLANTOLOGY

■ Инструменты для имплантологии
■ Implantologie
■ Implantologie

■ Инструменти для имплантології
■ Implantologia
■ زراعة الأسنان

Plugers Clarizio

Length 160 mm with titanium tips for mixing and pouring of autologous heterologous bone substitute material (3/4 or 6/8 mm)

BONE GRAFTING INSTRUMENTS



786-1587 Ø4mm
786-1588 Ø5mm
Compactor
150mm



786-1589
Sinus Window
Bone Tampers
4 mm



786-1590
Sinus Window
Bone Tampers
7 mm



786-1591
6/8mm



786-1592
3/4mm

IMPLANTOLOGY

■ Инструменты для имплантологии
 ■ Implantologie
 ■ Implantologie

■ Инструменти для имплантології
 ■ Implantoloia
 ■ زراعة الأسنان

SPOON AND PUSHER (TRINOVO)

Trinovo handle different workers, for bone material high grade medical stainless steel, corrosion-resistant

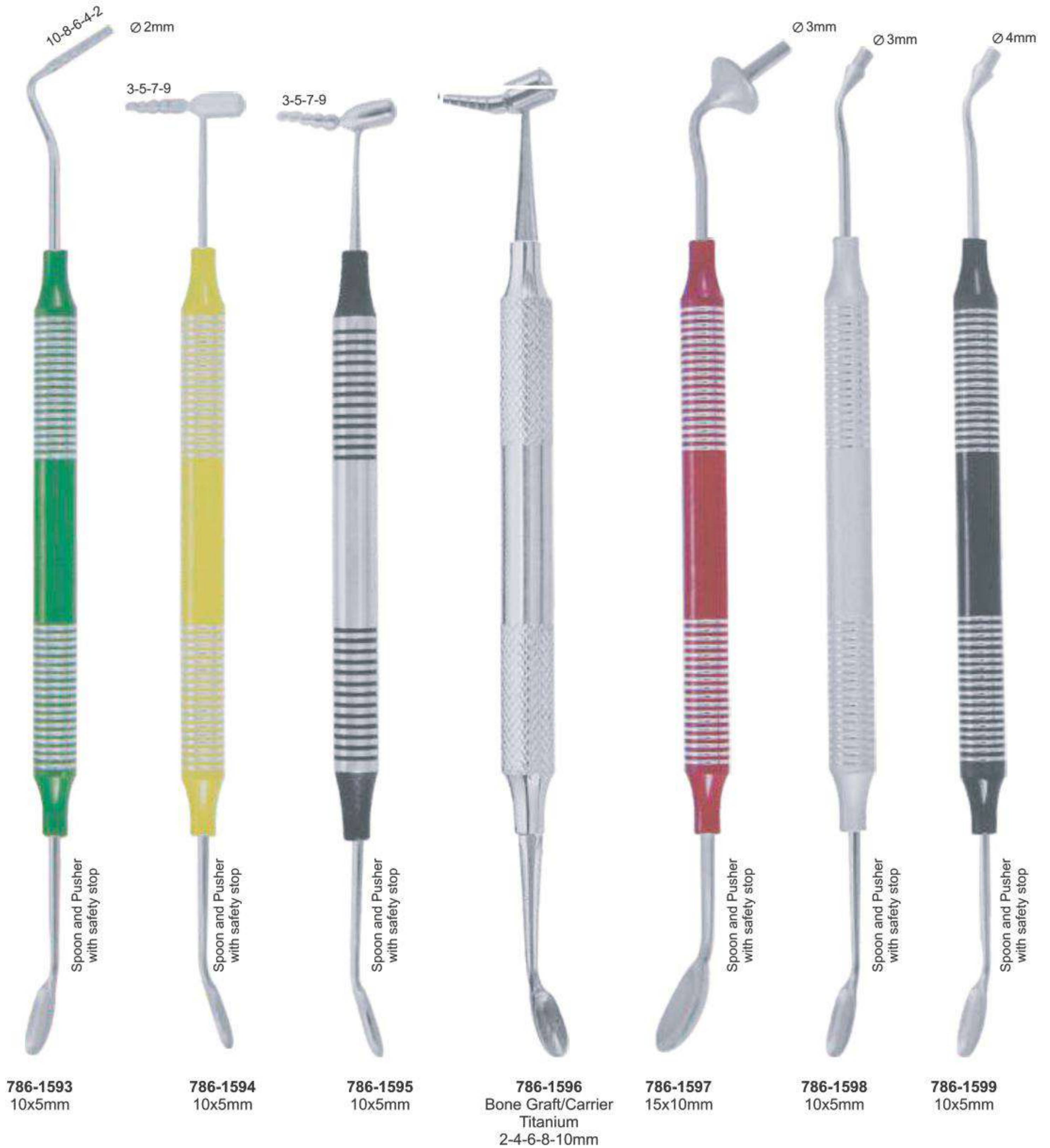

IMPLANTOLOGY

■ Инструменты для имплантологии
■ Implantologie
■ Implantologie

■ Инструменти для имплантології
■ Implantologia
■ زراعة الأسنان

PERIOSTEALS ELEVATOR 10mm Hollow Handle



786-1600
Raspator,
BonexScraper
Length 165 mm
10 mm hollow
handle,
double-ended
6 mm / 4 mm



786-1601
Raspator,
Raspatory
Length 180 mm
10 mm hollow
handle,
double-ended
3 mm / 3 mm



786-1602
Raspator,
Raspatory
Length 180 mm
10 mm hollow
handle,
double-ended
3 mm / 3 mm



786-1603
Raspator,
Papilla
Length 185 mm
10 mm hollow
handle,
double-ended
3 mm / 2 mm



786-1604
Raspator,
Bone Scraper
Length 175 mm
10 mm hollow
handle,
double-ended



786-1605
Raspator,
Micro-Freer
Length 180 mm
6 mm solid grip
double-ended
3 mm / 4 mm



786-1606
Raspator,
Micro-Freer
Length 180 mm
6 mm solid
handle
double-ended
5 mm / 5 mm

■ Инструменты для имплантологии
 ■ Implantologie
 ■ Implantologie

■ Instrumenti для имплантології
 ■ Implantoloia
 ■ زراعة الأسنان

PERIOSTEALS ELEVATOR 10mm Hollow Handle

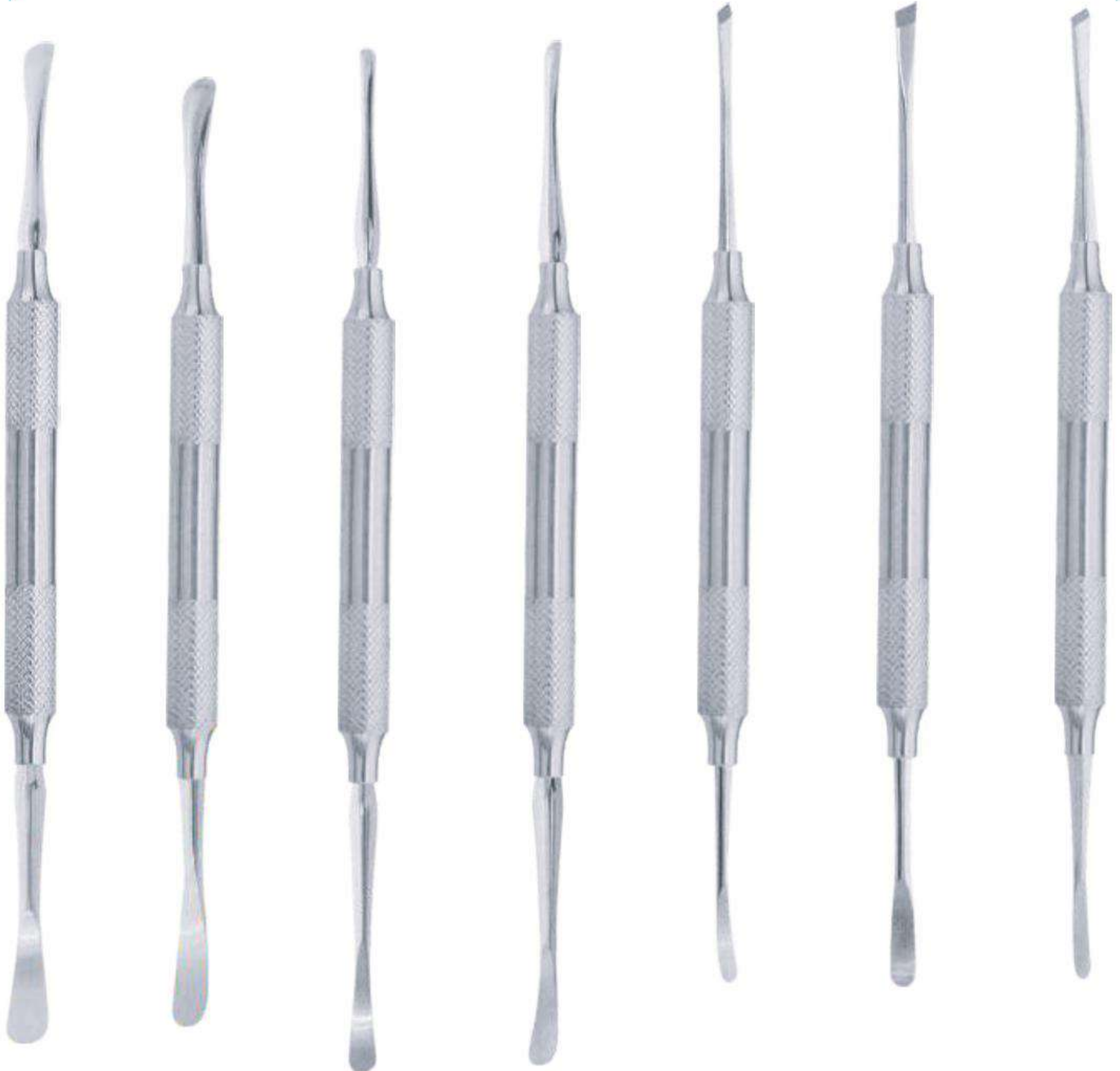

786-1607
Raspator,
Freer
 10 mm hollow
 handle
 high-quality
 medical
 double-ended

786-1608
Raspator,
Molt
 Length 180 mm
 8 mm solid grip
 double-ended
 6 mm

786-1609
Raspator,
Micro-Freer
 Length 185 mm
 10 mm hollow
 handle
 double-ended

786-1610
Raspator,
Micro-Freer
 Length 185 mm
 10 mm hollow
 handle
 double-ended

786-1611
Raspator,
**Micro Raspator/
 Chisel**
 Length 170 mm
 10 mm hollow
 handle
 double-ended

786-1612
Raspator,
**Micro Raspator/
 Chisel**
 Length 175 mm
 10 mm hollow
 handle
 double-ended

786-1613
Raspator,
**Micro Raspator/
 Chisel**
 Length 175 mm
 8 mm solid
 handle
 double-ended
 3.5mm / 3.5mm

IMPLANTOLOGY

■ Инструменты для имплантологии
 ■ Implantologie
 ■ Implantologie

■ Инструменти для имплантології
 ■ Implantologia
 ■ زراعة الأسنان

PERIOSTEALS ELEVATOR 10mm Hollow Handle



786-1614
Raspatory
Micro Molt
 Length 175 mm
 corrosion-resistant

786-1615
Raspatory Chipping
 Workers:
 Chisel 24G and 7.5mm
 Length about 175 mm
 corrosion-resistant

786-1616
Raspatory Molt
 Work ends:
 5.0 mm and 4.0 mm
 Length about 175 mm
 corrosion-resistant

786-1617
Rasp, Molt M9
 Length 175 mm
 corrosion-resistant

786-1618
Raspator, Wautier
 Length 175 mm
 corrosion-resistant

786-1619
Raspator, Benque
 Length 170 mm
 workers
 5 mm / 7 mm
 corrosion-resistant

786-1620
Raspator, Nordber
 Length 180 mm
 8 mm hollow handle
 double ended
 6 mm / 4 mm

IMPLANTOLOGY

■ Инструменты для имплантологии
■ Implantologie
■ Implantologie

■ Инструменти для імплантології
■ Implantologia
■ زراعة الأسنان

Hollow Handle 10mm Length 170mm

25mm
3.0mm

786-1621 Miller

25mm
3.5mm

786-1622 Miller

21mm
2.2mm

786-1623 LUCAS #84

21mm
2.6mm

786-1624 LUCAS #85

21mm
2.9mm

786-1625 LUCAS #86

21mm
3.5mm

786-1626 LUCAS #87

24mm
4.6mm

786-1627 LUCAS #88



786-1628 LUCAS86S
SERRATED



786-1629 LUCAS86AS
SERRATED

IMPLANTOLOGY

■ Инструменты для имплантологии
 ■ Implantologie
 ■ Implantologie

■ Инструменти для имплантології
 ■ Implantoloia
 ■ زراعة الأسنان

TISSUE MEMBRANE FORCEPS



786-1630
 Tissue Graft Forcep
 Serrated Teeth



786-1631
 Self Locking
 Grooved



786-1632
 Tissue Graft Forcep
 Serrated Teeth



786-1633
 Titanium
 Locking Plier



786-1634
 TC Gripper Carbide
 Tipped Tissue Forceps
 Serrated Carbide Tips
 14.5



786-1635
 Adson Carbide
 Tipped Tissue Forceps
 Serrated Carbide Tips
 12cm



786-1636
 Micro Adson 1x2
 Tissue Forcep 12.1cm
 1x2 Teeth - 0.5mm Tips



786-1637
 Adson 7x7
 Tissue Forceps
 7x7 Teeth 12cm



786-1638
 Adson 7x7 Curved
 Tissue Forceps
 7x7 Teeth 12cm



786-1639
 Suture Pliers
 Suture Forceps with
 1.6mm Ring Tip



786-1640
 Debakey Atraumatic
 Tissue Forceps Straight
 Serrated Teeth
 16cm



786-1641
 Debakey Atraumatic
 Tissue Forceps Curved
 Serrated Teeth
 16cm

■ Инструменты для имплантологии
 ■ Implantologie
 ■ Implantologie

■ Инструменти для імплантології
 ■ Implantologia
 ■ زراعة الأسنان

TISSUE MEMBRANE FORCEPS



786-1642
 Russian Long
 Tissue Forceps
 Serrated Tip
 20cm



786-1643
 Russian
 Tissue Forceps
 Serrated Tip
 15cm



786-1644
 Tissue Punch Forceps
 To Remove Tissue
 After Using Punch



786-1645
 13.5 cm
 narrow



786-1646
 10.5 cm
 Membrane Tweezer Kuehne



786-1647
 13.5 cm
 wide



786-1648
 Pin Tweezers
 with or without lock
 length 15 cm,
 with lock



786-1649
 without lock



786-1650
 Haltepinzette with lock
 15.5 cm, for pins, towards
 the tips, etc,



786-1651
 Carry Forceps
 15cm



786-1652
 Carry Forceps
 15cm



786-1653
 Carry Forceps
 15cm

IMPLANTOLOGY

■ Инструменты для имплантологии
 ■ Implantologie
 ■ Implantologie

■ Инструменти для имплантології
 ■ Implantologia
 ■ زراعة الأسنان

OSTEOTOME CONVEXES / CONCAVE / CONIQUES

CONVEXES

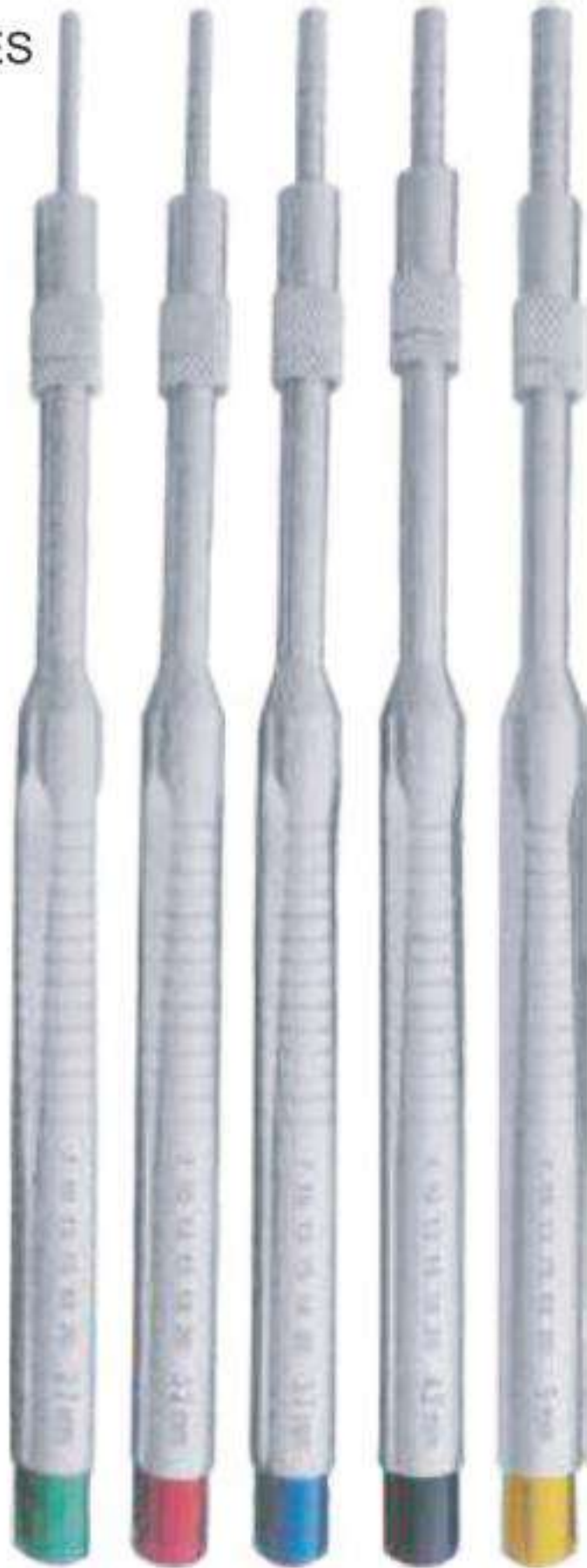

786-1654
SET OF 5 PIECES

CONCAVE



786-1655
SET OF 5 PIECES

CONIQUES



786-1656
SET OF 5 PIECES

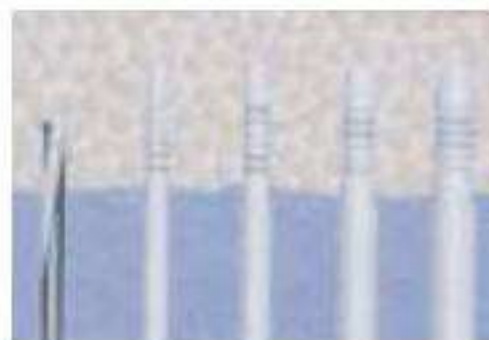

	CONVEXES STRAIGHT	786-1654	2.7 Ømm	3.2 Ømm	3.7 Ømm	4.2 Ømm	5.0 Ømm
	CONVEXES STRAIGHT	786-1655	2.7 Ømm	3.2 Ømm	3.7 Ømm	4.2 Ømm	5.0 Ømm
	CONVEXES STRAIGHT	786-1656	2.7 Ømm	3.2 Ømm	3.7 Ømm	4.2 Ømm	5.0 Ømm

IMPLANTOLOGY

■ Инструменты для имплантологии
 ■ Implantologie
 ■ Implantologie

■ Инструменти для імплантології
 ■ Implantologia
 ■ زراعة الأسنان

OSTEOTOME CONVEXES / CONCAVE / CONIQUES

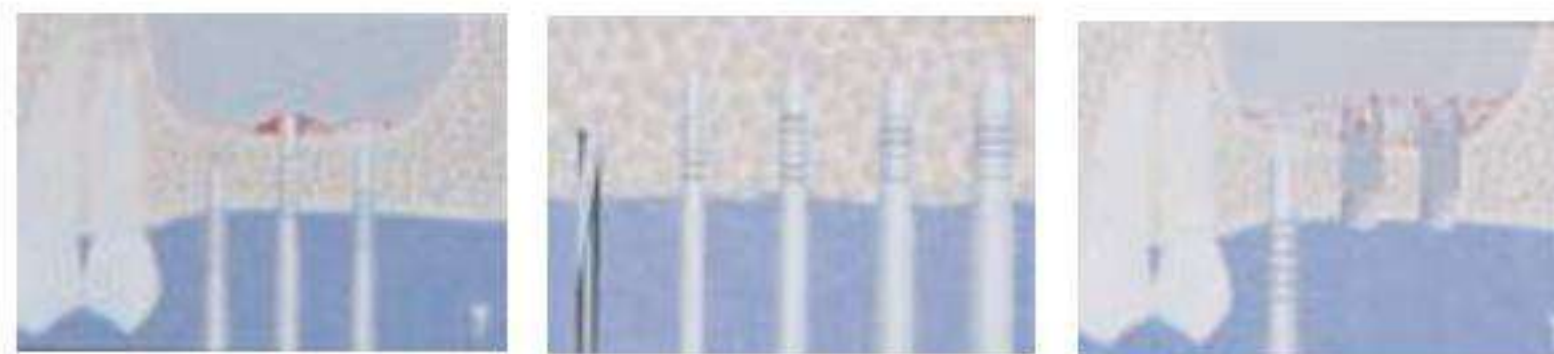
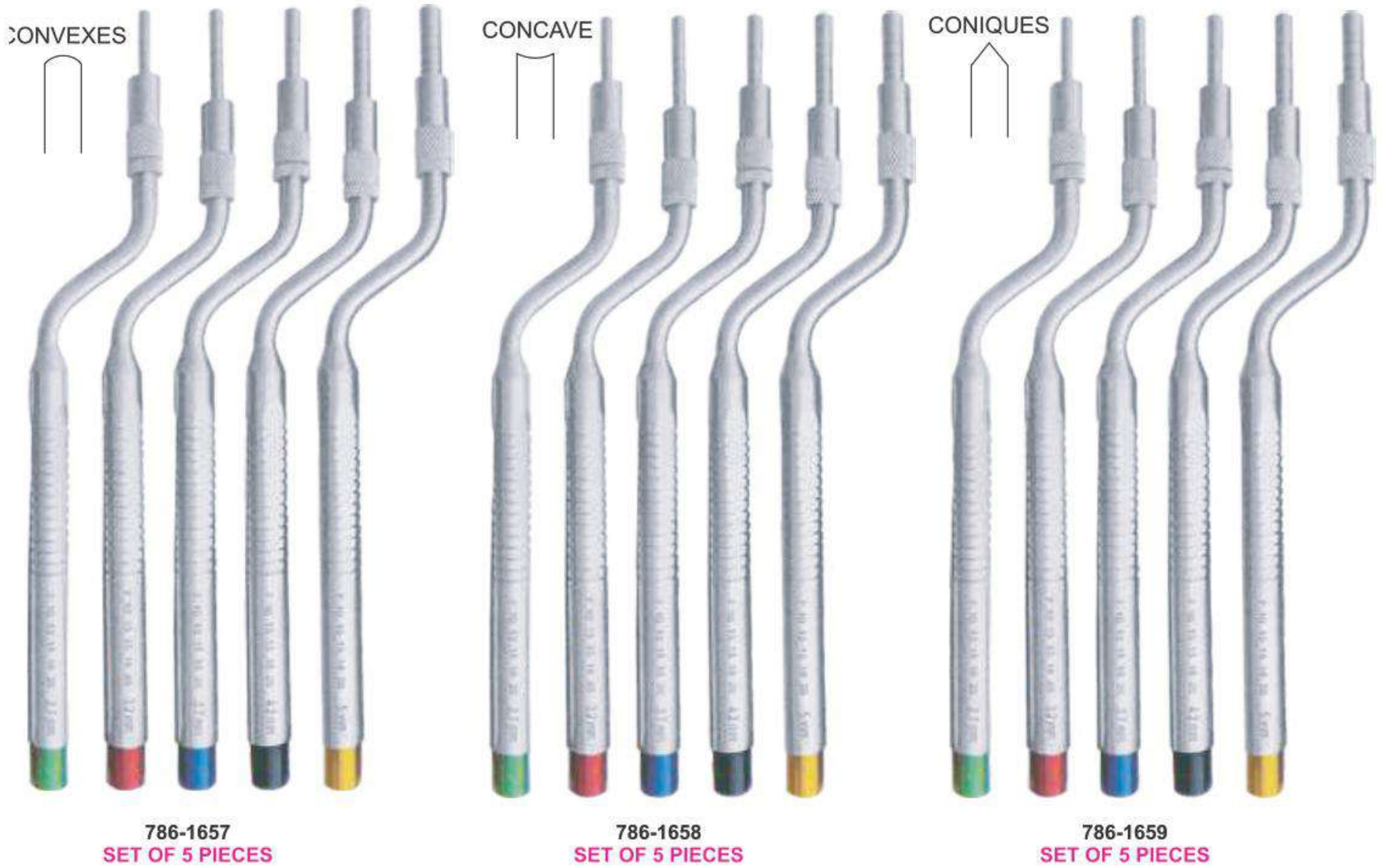

	CONVEXES STRAIGHT	786-1657	2.7 Ømm	3.2 Ømm	3.7 Ømm	4.2 Ømm	5.0 Ømm
	CONVEXES STRAIGHT	786-1658	2.7 Ømm	3.2 Ømm	3.7 Ømm	4.2 Ømm	5.0 Ømm
	CONVEXES STRAIGHT	786-1659	2.7 Ømm	3.2 Ømm	3.7 Ømm	4.2 Ømm	5.0 Ømm

IMPLANTOLOGY

■ Инструменты для имплантологии
 ■ Implantologie
 ■ Implantologie

■ Инструменти для имплантології
 ■ Implantologia
 ■ زراعة الأسنان

TREPHINE

Burs with depth markings are suited for precise and simple transplantation of cylindrical bone grafts as well as for all other bone extraction tasks.



786-1660	786-1661	786-1662	786-1663	786-1664	786-1665	786-1666	786-1667	786-1668
∅ Int. 2.0mm ∅ Ext.3.0mm	∅ Int. 3.0mm ∅ Ext.3.5mm	∅ Int. 4.0mm ∅ Ext.5.0mm	∅ Int. 5.0mm ∅ Ext.6.0mm	∅ Int. 6.0mm ∅ Ext.7.0mm	∅ Int. 7.0mm ∅ Ext.8.0mm	∅ Int. 8.0mm ∅ Ext.9.0mm	∅ Int. 9.0mm ∅ Ext.10.0mm	∅ Int. 10 mm ∅ Ext.11mm



786-1669
Tissue Punch with pin
Set of Four Pieces

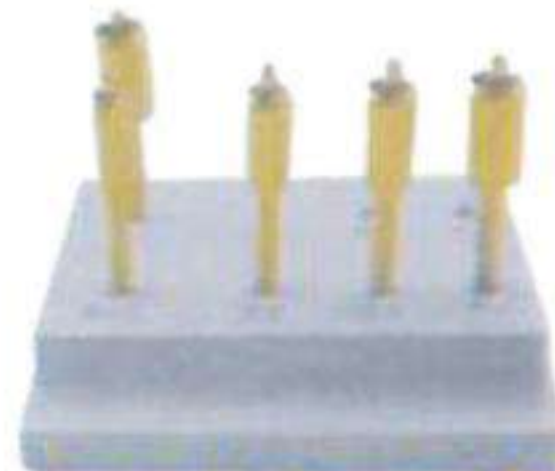

786-1670
Tissue Punch
Set of Five Pieces



786-1671
Tissue Punch with pin
Set of Five Pieces



786-1672
Trepine Drill
Set of Eight Pieces



∅2.0mm ∅2.5mm ∅2.8mm ∅3.2mm ∅3.65mm ∅4.2mm ∅5.2mm

786-1673
Short Implant Drills

786-1674
Long Implant Drills



786-1675
Trepine Drill
Set of Eight Pieces

IMPLANTOLOGY

■ Инструменты для имплантологии
 ■ Implantologie
 ■ Implantologie

■ Инструменти для імплантології
 ■ Implantologia
 ■ زراعة الأسنان

BONE SCRAPER STRAIGHT & CURVED



786-1676
Bone Scraper
Straight

786-1677
Bone Scraper
Curved

TISSUE PUNCH STRAIGHT & CURVED



786-1678
Tissue Punch
Straight

786-1685
Tissue Punch
Curved

786-1679
2.0mm

786-1680
4.0mm

786-1681
5.0mm

786-1682
6.0mm

786-1683
7.0mm

786-1684
8.0mm

786-1686
2.0mm

786-1687
4.0mm

786-1688
5.0mm

786-1689
6.0mm

786-1690
7.0mm

786-1691
8.0mm



786-1692
Bone Mill



786-1693
Basins for Bone

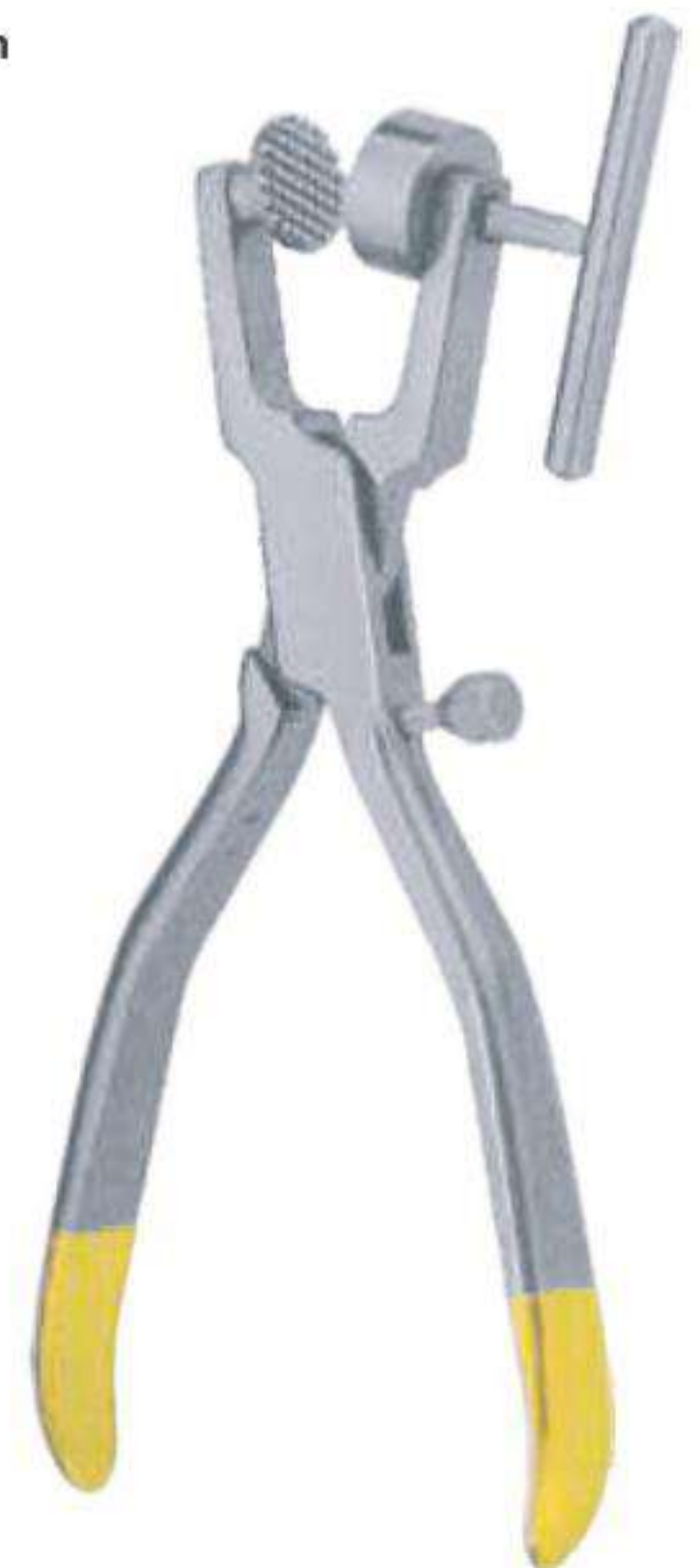

786-1694
BONE CRUSHER

IMPLANTOLOGY

■ Инструменты для имплантологии
 ■ Implantologie
 ■ Implantologie

■ Инструменти для имплантології
 ■ Implantologia
 ■ زراعة الأسنان

KEYS FOR IMPLANT SCREW



786-1695



786-1696



786-1697



786-1698

TORQUE WRENCH & RATCHET



786-1699
Star Torque Wrench 6.35mm Universal



786-1700
Round Torque Wrench 4.0mm Universal



786-1701
Hex Driver with 4.0mm Driver



786-1702
Star Torque Wrench 6.35mm Universal



786-1703
Hex Torque Wrench 4.0mm Universal



786-1704
Star Torque Wrench 6.35mm Universal



786-1705
Star Torque Wrench 6.35mm Universal



786-1706
Star Torque Wrench 6.35mm Universal



786-1707
Star Torque Wrench 6.35mm Universal



786-1708
Star Torque Wrench 6.35mm Universal



786-1709
Star Ratchet Wrench 6.35mm Universal



786-1710
Star Ratchet Wrench 6.35mm Universal



786-1711
Star Ratchet Wrench 6.35mm Universal



786-1712
Star Ratchet Wrench 4.0mm Universal



786-1713
Round Ratchet Wrench 4.0mm Universal



786-1714
Round Ratchet Wrench 3.35mm Universal



786-1715
Star Ratchet Wrench 4.0mm Universal



786-1716
Star Ratchet Wrench 6.35mm Universal

IMPLANTOLOGY

■ Инструменты для имплантологии
 ■ Implantologie
 ■ Implantologie

■ Инструменти для імплантології
 ■ Implantoloia
 ■ زراعة الأسنان

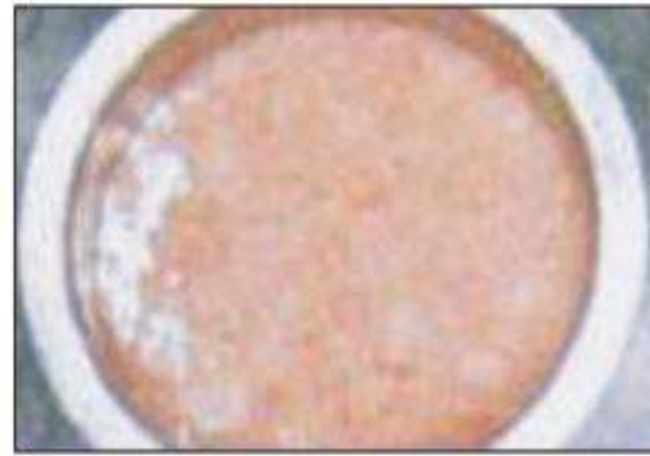
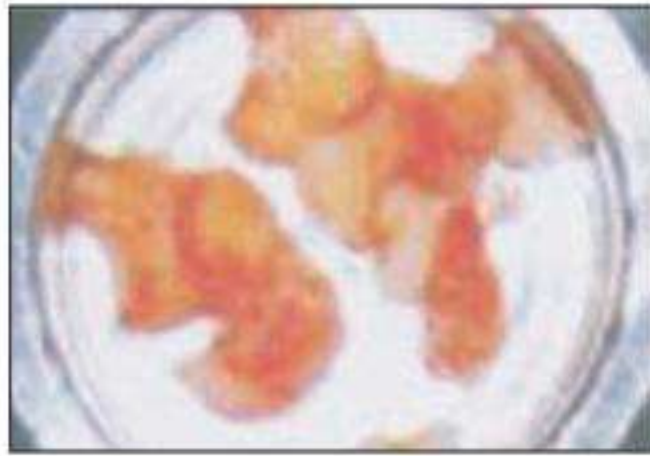

786-1717
BONE CRUSHER
 Titanium Metal Cutter

Mallet



786-1718
BONE CRUSHER
 Titanium Metal Cutter

Mallet



786-1719
BONE CRUSHER



786-1720
BONE CRUSHER
 Bone Grinding Grain
 1.5mm, 2mm, 2.5mm

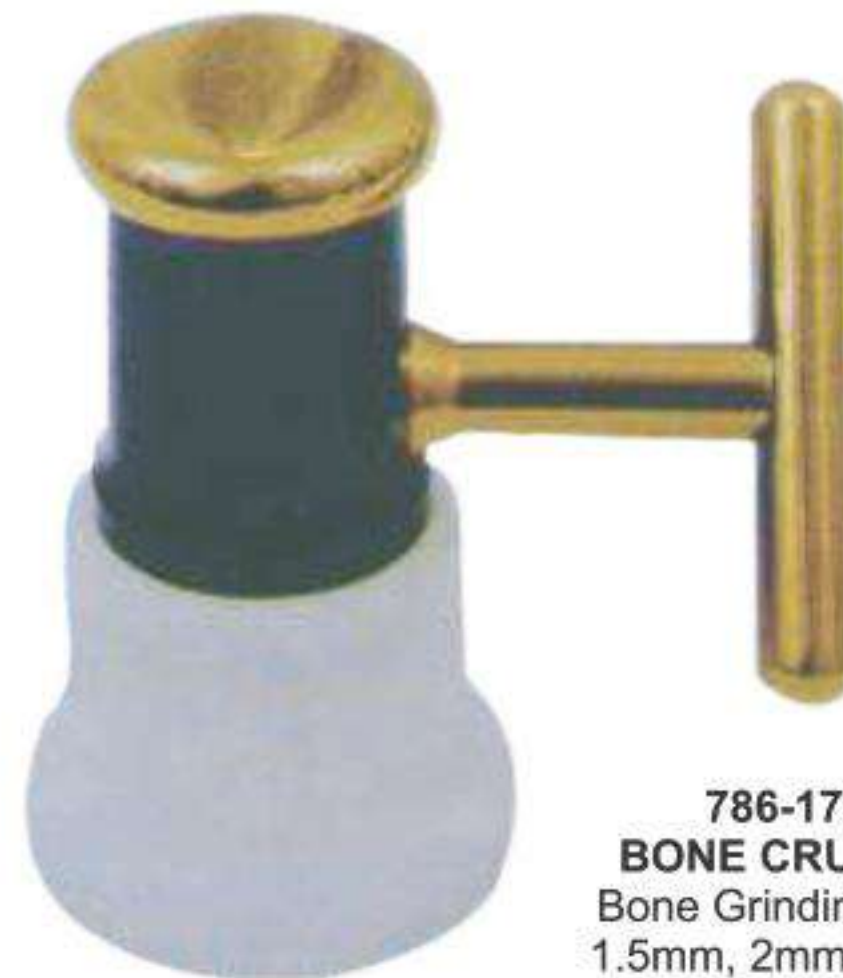

786-1721
BONE CRUSHER
 Bone Grinding Grain
 1.5mm, 2mm, 2.5mm

IMPLANTOLOGY

■ Инструменты для имплантологии
 ■ Implantologie
 ■ Implantologie

■ Инструменти для имплантології
 ■ Implantologia
 ■ زراعة الأسنان

BONE EXPANDER SCREW & SURGICAL KITS



786-1722
 Bone Universal Kit
 Drill 2mm, 2.8mm, 3.2mm, 3.65mm
 4.2mm, 4.5mm, 4.8mm, 5.2mm
 Trephines Bit:
 3.0mm, 4.0mm, 5.0mm, 6.0mm
 7.0mm, 8.0mm, 9.0mm, 10.0mm
 Driver:
 2.5mm, 2.5mm Hand Pcs
 1.25mm, 1.25mm Hand Pcs
 Short Driver 2.5mm
 Long Driver 2.5mm
 1.25mm, Short Hex Driver Hand Pcs
 1.25mm, Long Hex Hand Pcs
 Torque Wrench 4.0mm



786-1723
 Bone Expander Kit
 Expander 2.5mm, 3.0mm
 3.4mm, 3.8mm, 4.3mm
 Ratchet Driver:
 Parallel Pin
 Pilot Drill
 Drill 1.4mm
 Drill Driver 4mm
 Hand Driver 4mm
 Ratchet 4.0mm



786-1724
 Bone Universal Kit
 Drill 2mm, 2.8mm, 3.2mm, 3.65mm
 4.2mm, 4.5mm, 4.8mm, 5.2mm
 Trephines Bit:
 3.0mm, 4.0mm, 5.0mm, 6.0mm
 7.0mm, 8.0mm, 9.0mm, 10.0mm

Bone Compression:
 2mm, 3.3mm, 2.8mm, 4.2mm, 3mm, 3.5mm
 Driver:
 2.5mm, 2.5mm Hand Pcs
 1.25mm, 1.25mm Hand Pcs
 Short Driver 2.5mm
 Long Driver 2.5mm
 1.25mm, Short Hex Driver Hand Pcs
 1.25mm, Long Hex Driver Hand Pcs
 Torque Wrench 6.35mm 1 Pcs



786-1725
 Conical Drills: 20 Pcs
 Tissue Punches:
 3.0mm, 3.50mm, 4.0mm, 4.5mm
 5.0mm, 6.0mm, 6.50mm
 Bone Expander:
 1.6/3.8mm, 2.9/3.0mm, 2.1/3.6mm
 2.6/3.8mm, 2.9/4.3mm
 Drill Adapter: 1 Pcs
 1.25mm, 2.50mm, Hex Driver Hand Pcs

Pilot Drill 1.6mm
 Drill Bit: 1.4mm, 1.6mm, 1.8mm,
 2.0mm, 2.2mm
 Ratchet Driver: 4mm/6.35, 1.25/2.50
 Rimer: 3.2/4.7mm, 3.7/4.7mm
 Parallel Pin: 4.5mm, 2.5mm
 Double step Drill: 2.4/2.8mm
 Depth Gauge 1Pcs
 Torque Wrench 6.35mm Universal 1Pc

■ Инструменты для имплантологии
 ■ Implantologie
 ■ Implantologie

■ Инструменти для имплантології
 ■ Implantologia
 ■ زراعة الأسنان

BONE INJECTORS, COLLECTORS & SUCTION TUBE

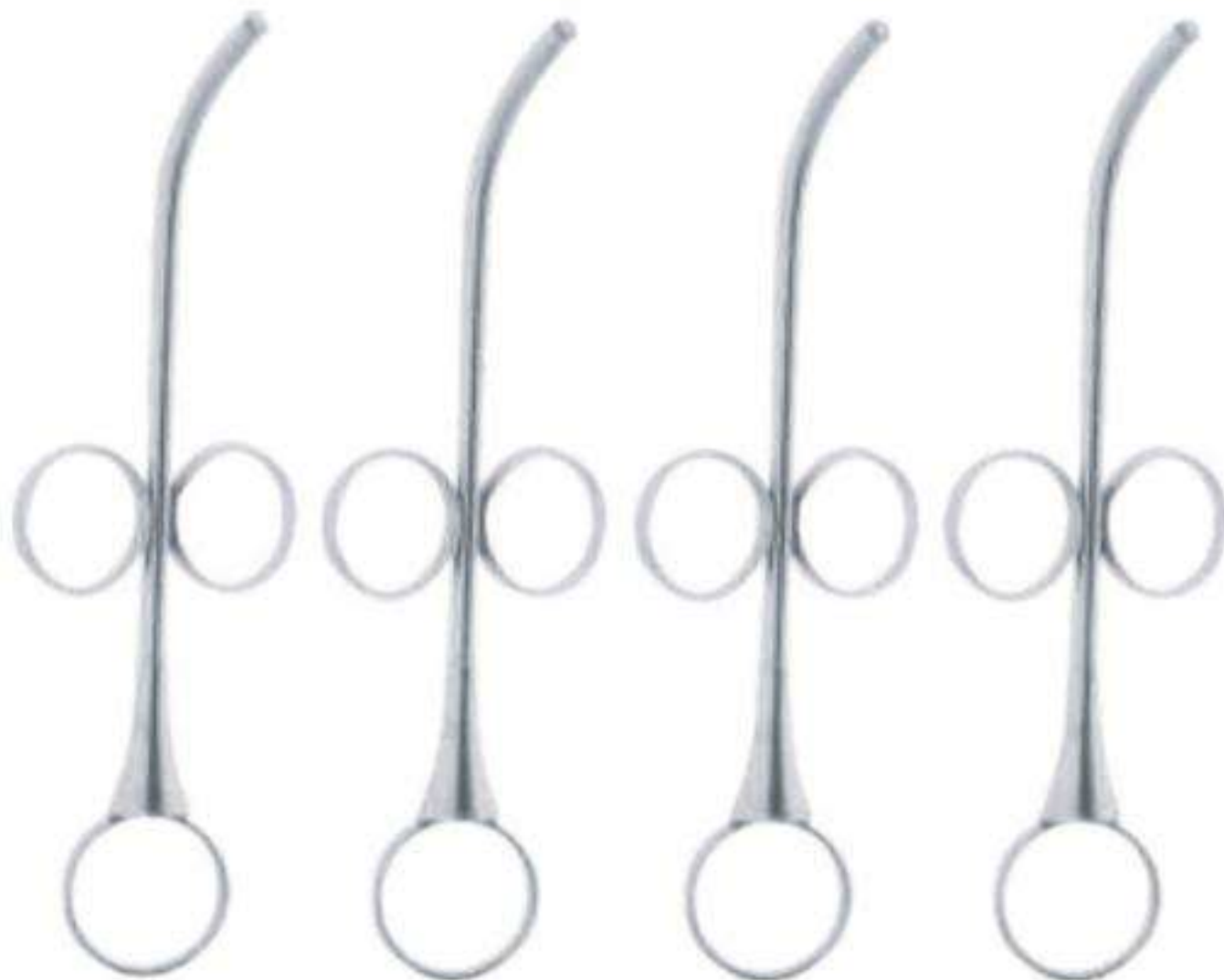

786-1726
 Ø2.5mm/
 3.5mm
 170mm

786-1727
 Ø4.5mm/
 5.5mm
 170mm

786-1728
 Ø3.5mm/
 4.5mm
 170mm

786-1729
 Ø6.0mm/
 7.0mm
 170mm

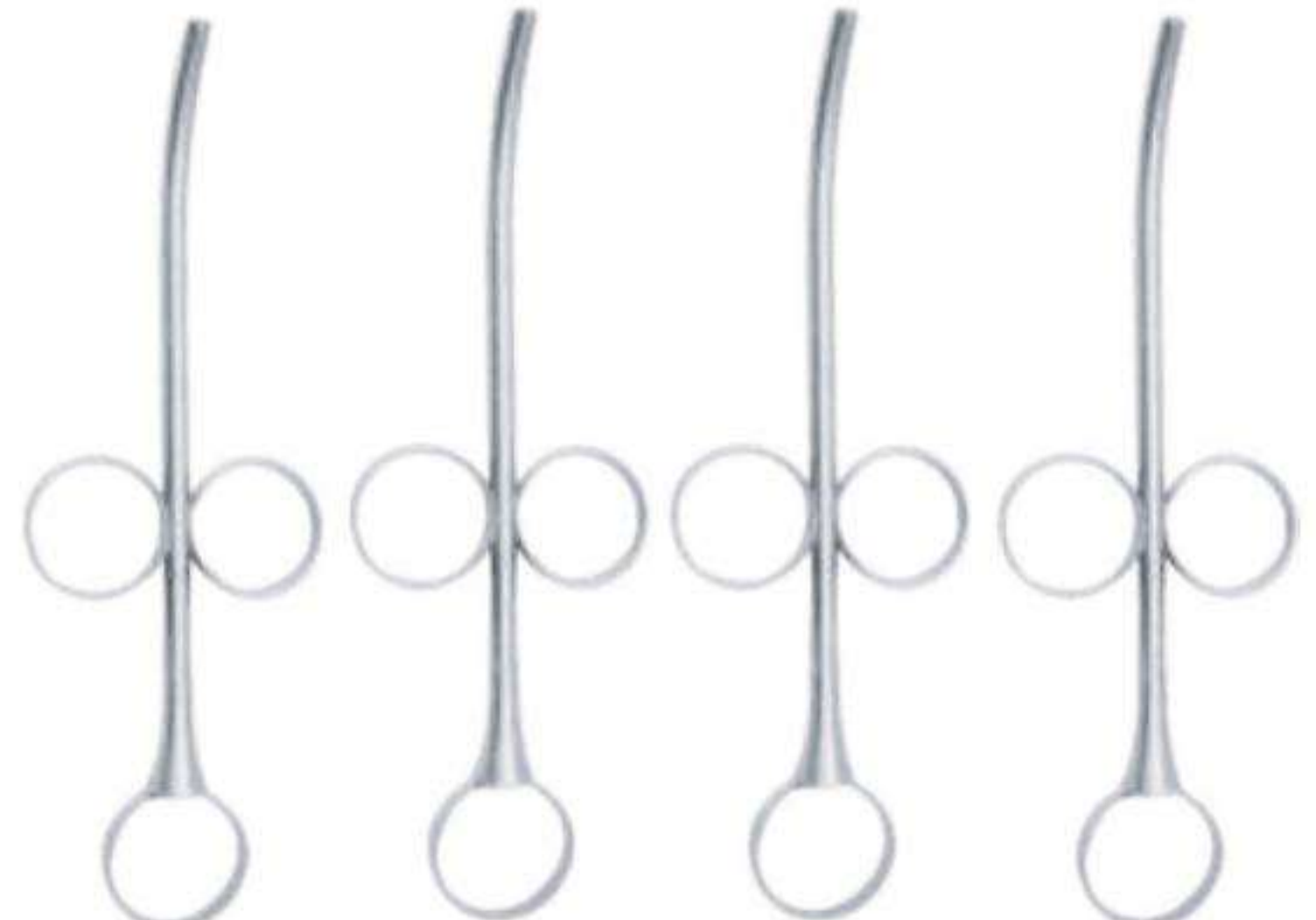

786-1730
 18cm
 Straight / Bend
 I.D 2.5mm
 O.D 3.5

786-1731
 18cm
 Straight / Bend
 I.D 3.5mm
 O.D 4.5

786-1732
 18cm
 Straight / Bend
 I.D 4.5mm
 O.D 5.5

786-1733
 18cm
 Straight / Bend
 I.D 6.0mm
 O.D 7.0



2cm

2.7cm

With Filter

786-1734
 17.5cm

786-1735
 18cm

786-1736
 coarse
 Ø5mm
 Suction tubes
 to collect
 the extracted
 bone material
 180mm

786-1737
 fine
 Ø9mm



1.5cm

3cm

5cm

786-1738
 Suction
 Tubes
 180mm

786-1739
 Suction
 Tubes
 180mm

786-1740
 Suction
 Tubes
 180mm



786-1742
 Ø3 mm
 length 180mm
789-1743
 Ø4 mm
 length 180mm
789-1744
 Ø5 mm
 length 180mm

786-1741
 Fig. 6FR
 Frazier
 15 cm -Ø2mm

IMPRESSION TRAYS

- Оттисковый ложки
- Porte-empreinte
- Abdruckloffel

- Відбиткові ложки
- Cubetas para Impresiones
- صواني الانطباع

PERFORATED WITH RIM LOCK

Set of 6 Pcs

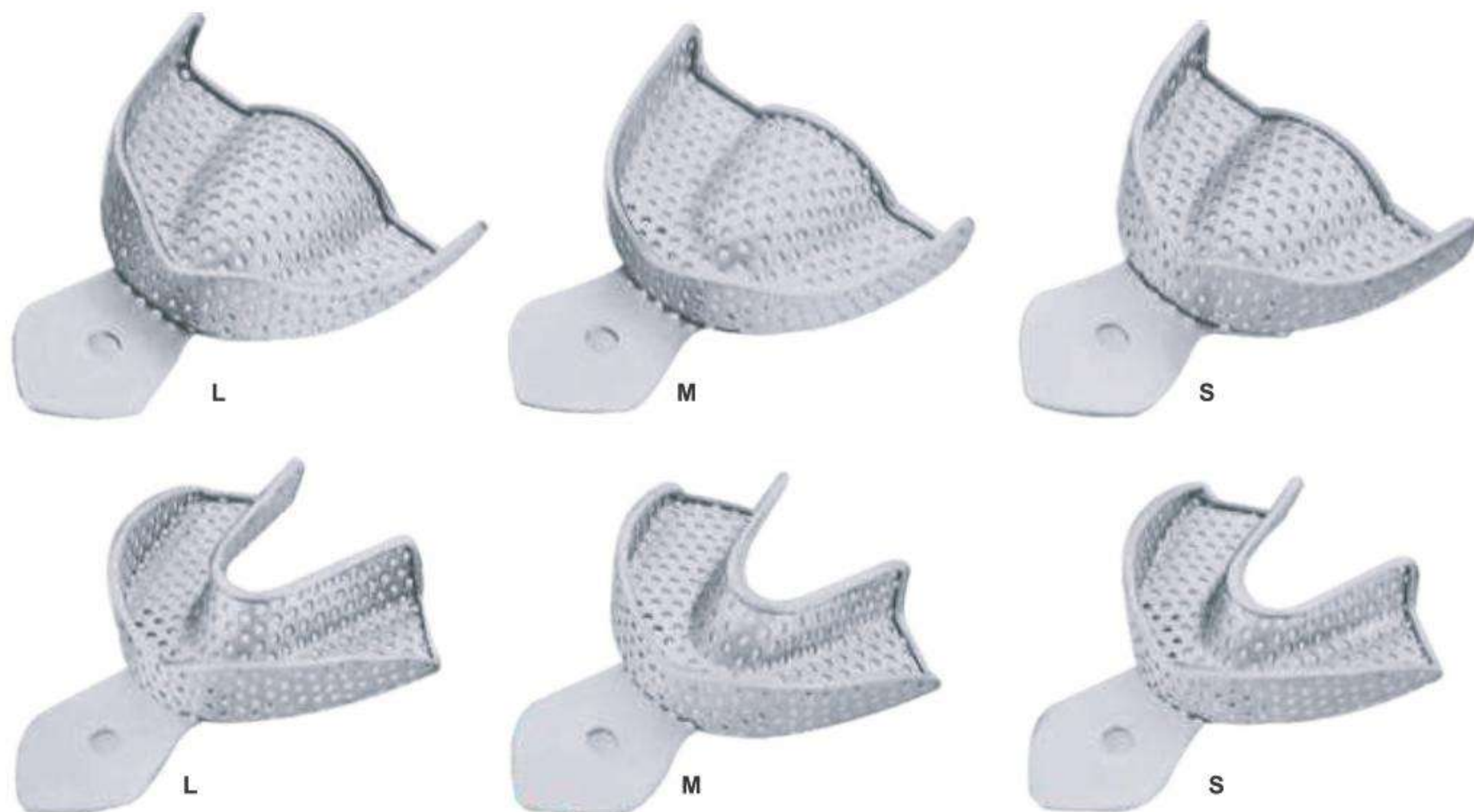

786-1745 SET OF 6 PCS

Upper S, M, L
Lower S, M, L

PERFORATED WITH RIM LOCK

Set of 8 Pcs

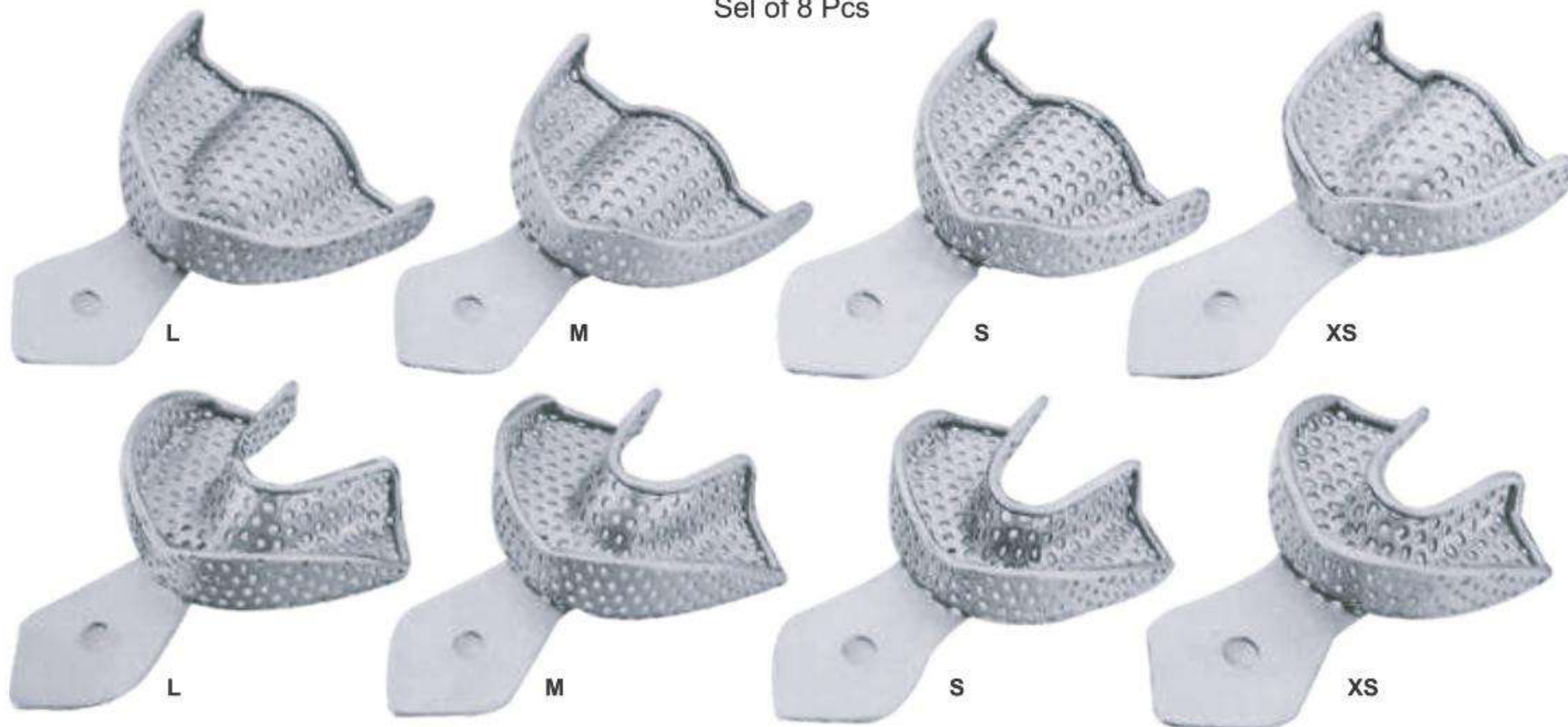

786-1746 SET OF 8 PCS

Upper XS, S, M, L
Lower XS, S, M, L

786-1747 SET OF 8 PCS

Upper S, M, L, XL
Lower S, M, L, XL

786-1748 SET OF 10 PCS

Upper XS, S, M, L, XL
Lower XS, S, M, L, XL

IMPRESSION TRAYS

■ Оттисковые ложки
 ■ Porte-empreinte
 ■ Abdruckloffel

■ Відбиткові ложки
 ■ Cubetas para Impresiones
 ■ صواني الانطباع

SOLID WITH RIM LOCK

Set of 6 Pcs



786-1749 SET OF 6 PCS

Upper S, M, L
 Lower S, M, L

SOLID WITH RIM LOCK

Set of 8 Pcs

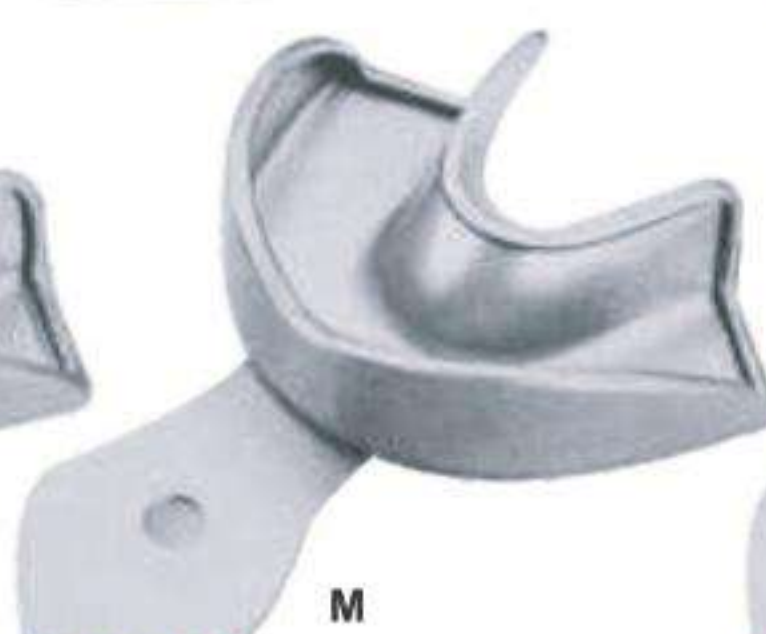

786-1750 SET OF 86 PCS

Upper XS, S, M, L
 Lower XS, S, M, L

786-1751 SET OF 8 PCS

Upper S, M, L, XL
 Lower S, M, L, XL

786-1752 SET OF 8 PCS

Upper XS, S, M, L, XL
 Lower XS, S, M, L, XL

IMPRESSION TRAYS

- Оттисковые ложки
- Porte-empreinte
- Abdruckloffel

- Відбиткові ложки
- Cubetas para Impresiones
- صواني الانطباع

PERFORATED FULL DENTURE

Set of 8 Pcs

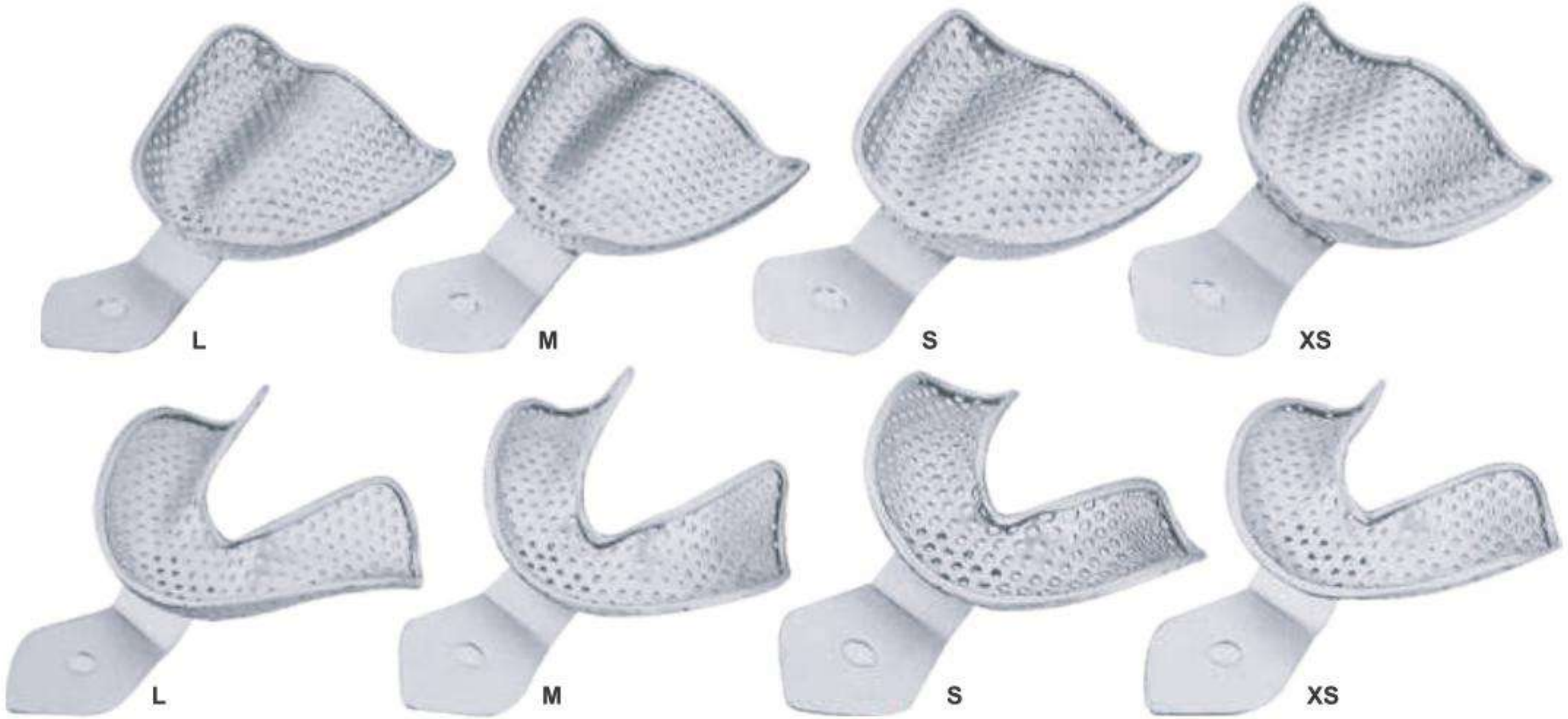

786-1753 SET OF 8 PCS

Upper S, M, L, XL
Lower S, M, L, XL

786-1754 SET OF 8 PCS

Upper S, M, L
Lower S, M, L

SOLID FULL DENTURE

Set of 8 Pcs

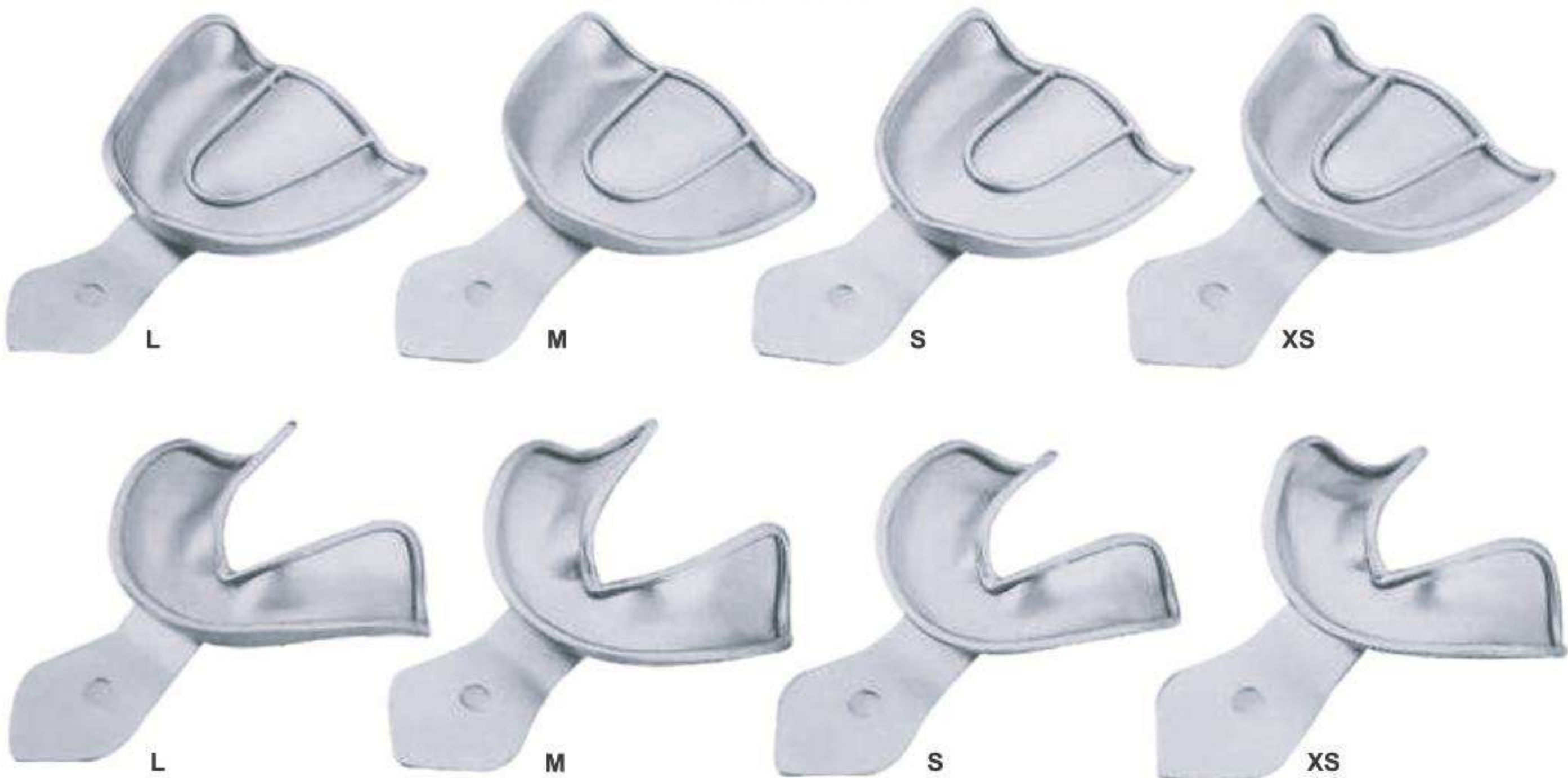

786-1755 SET OF 8 PCS

Upper S, M, L, XL
Lower S, M, L, XL

786-1756 SET OF 6 PCS

Upper S, M, L
Lower S, M, L

IMPRESSION TRAYS

■ Оттисковые ложки
 ■ Porte-empreinte
 ■ Abdruckloffel

■ Відбиткові ложки
 ■ Cubetas para Impresiones
 ■ صواني الانطباع

PERFORATED WITHOUT RIM LOCK

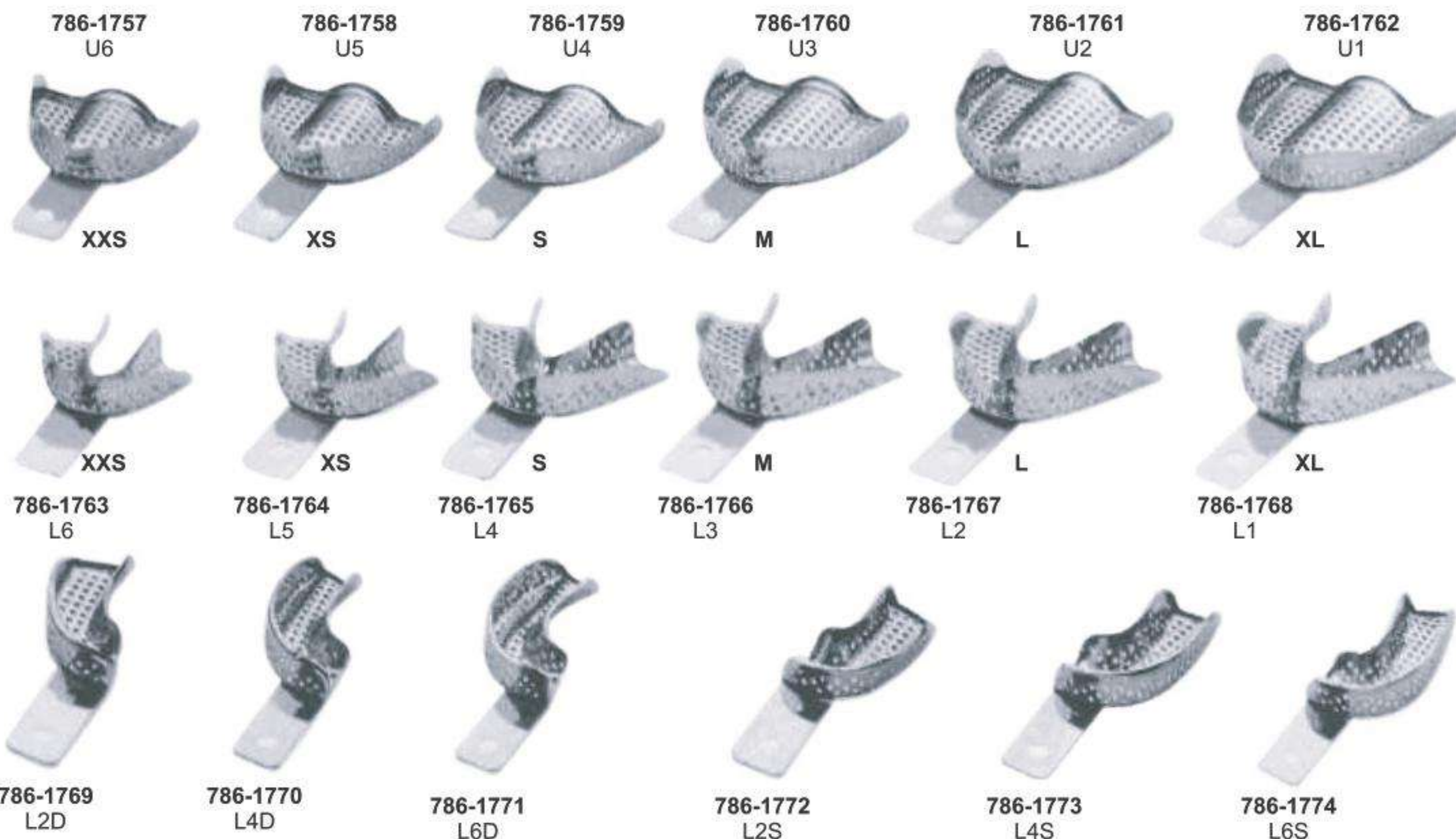

SOLID WITH RIM LOCK

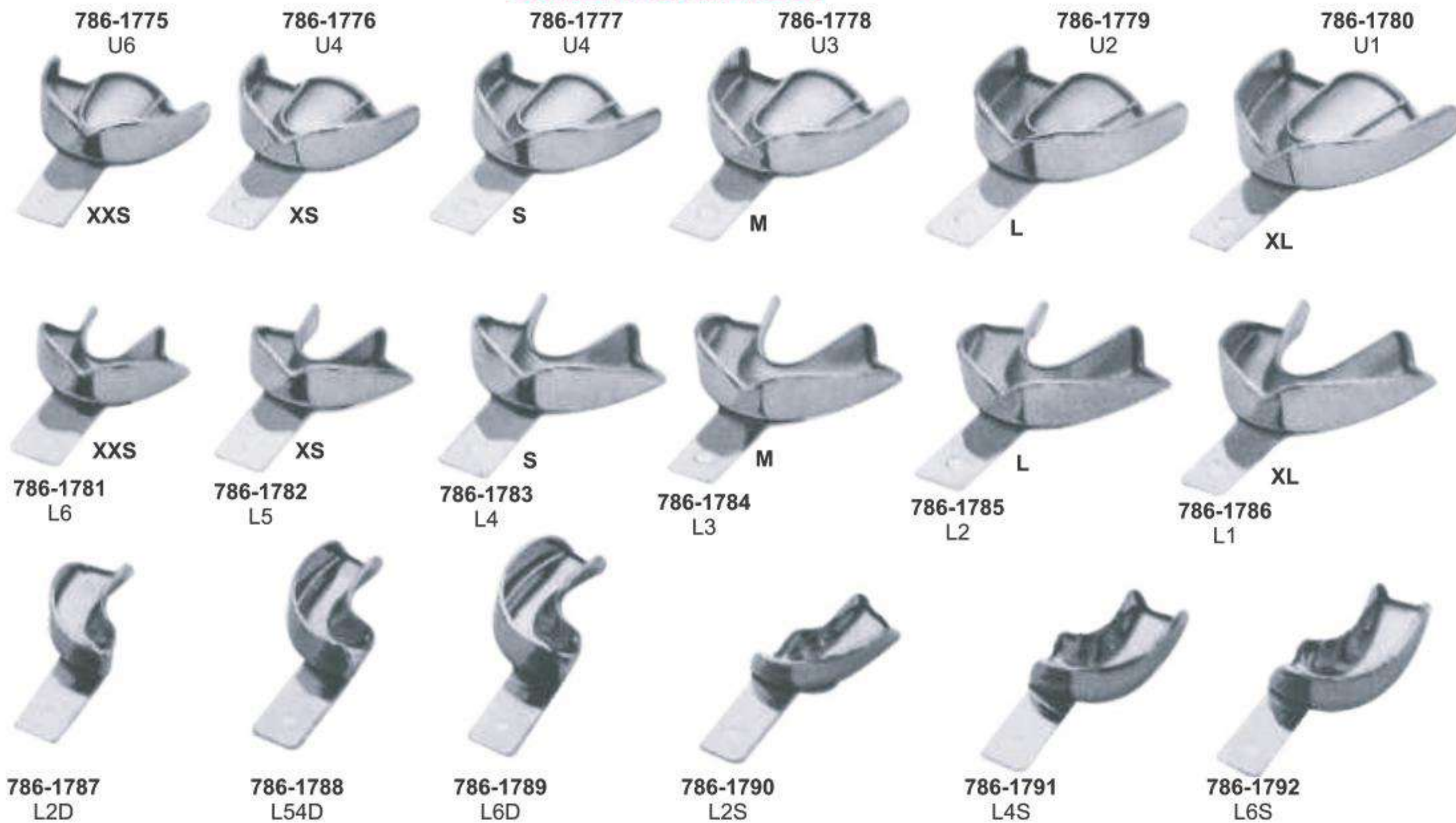

INSTRUMENTS CASSETTES & STANDS



786-1793
Instruments Cassettes
5 Pieces, 7 Pieces, 10 Pieces & 20 Pieces



786-1794
Instruments Cassettes
5 Pieces, 7 Pieces, 10 Pieces & 20 Pieces

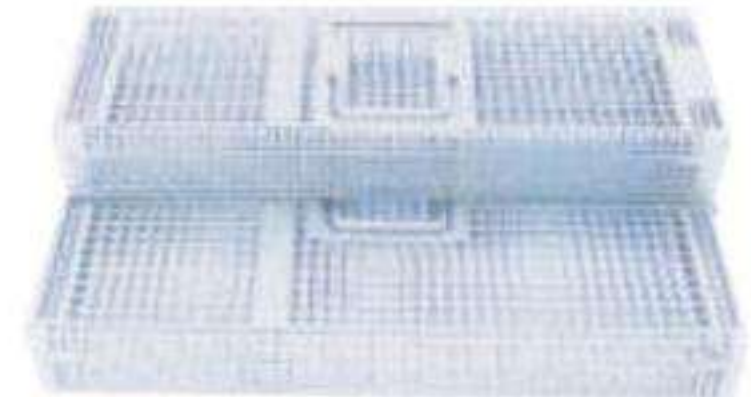

786-1795
Instruments Cassettes
7 Pieces & 100 Pieces



786-1796
Gracey Curette Set Cassettes



786-1797
182 x 150 x 20 mm
10 Instruments



786-1798
182 x 85 x 15 mm
5 Instruments



786-1799
288 x 182 x 35 mm
20 Instruments



786-1800
288 x 182 x 35 mm
20 Instruments



786-1801
288 x 145 x 35 mm
10 Instruments

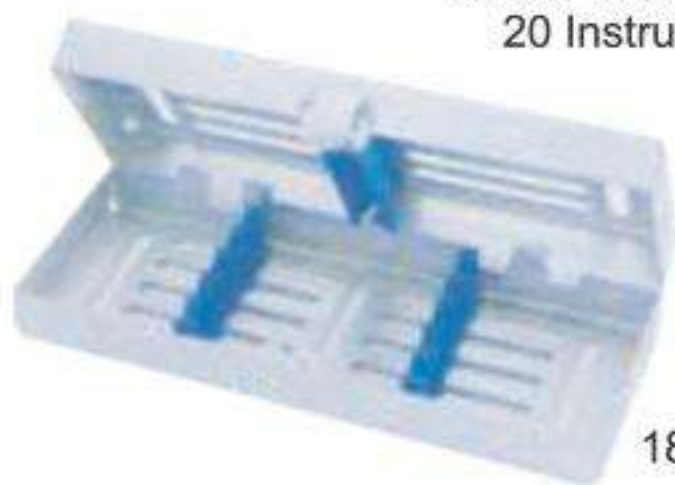

786-1802
1828 x 72 x 35 mm
5 Instruments

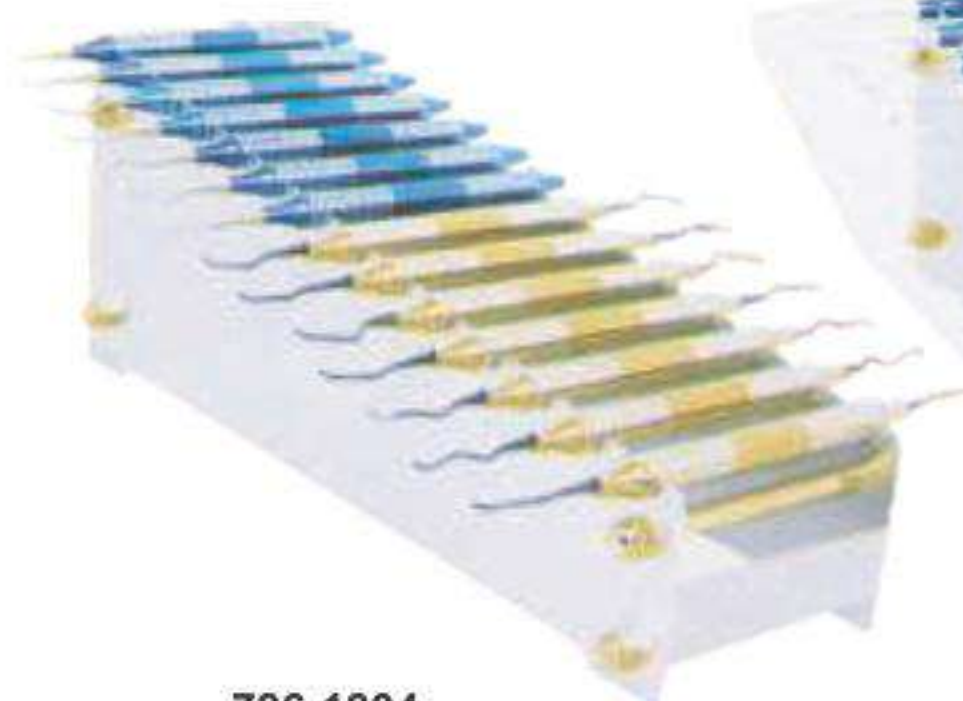

786-1804
Gracey Curette Set Stand

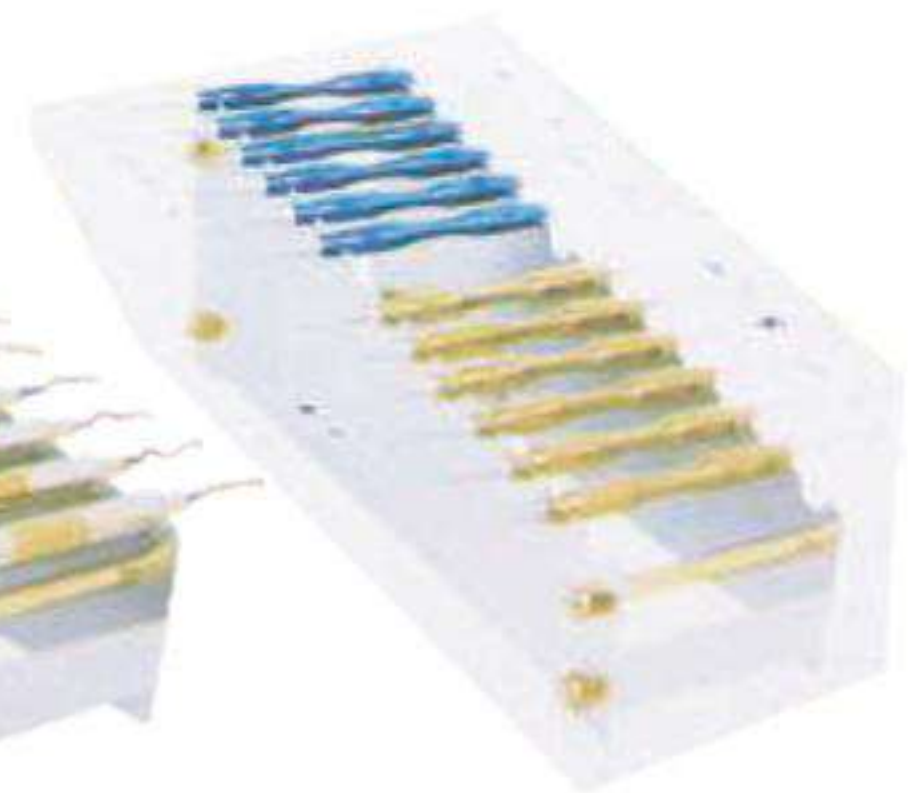

786-1805
Sinus Lift Set Stand



786-1803
182 x 145 x 35 mm
9 Instruments

HOLLWO WARE

MADE OF 18/8 STAINLESS STEEL



KIDNEY TRAY WITH COVER
(English Pattern)

	Size
786-1806	150 mm
786-1807	200 mm
786-1808	240 mm
786-1809	300 mm



KIDNEY TRAY

	With lid available	Without lid available
786-1810	6"	786-1814 6"
786-1811	8"	786-1815 8"
786-1812	10"	786-1816 10"
786-1813	12"	786-1817 12"



	Deep
786-1818	2.25" - 2"
786-1819	4.75" - 2"
786-1820	5.5" - 2.5"
786-1821	6.25" - 2.75"
786-1822	7" - 3.5"



Sterilizing Drum

Art #	mm	h mm
786-1823	80 mm	80
786-1824	120 mm	120
786-1825	160 mm	120
786-1826	190 mm	140
786-1827	190 mm	200
786-1828	240 mm	120
786-1829	240 mm	160
786-1830	240 mm	240
786-1831	290 mm	120
786-1832	290 mm	160
786-1833	290 mm	240
786-1834	340 mm	160
786-1835	340 mm	240
786-1836	390 mm	145
786-1837	390 mm	200
786-1838	390 mm	290



Cotton Holder
786-1839



Sprint Lamp
786-1840



786-1841
Endodontic Box



	Forcep Jar
786-1842	25 x 80 mm
786-1843	30 x 100 mm
786-1844	100 x 200 mm
786-1845	75 x 173 mm



786-1846	6" x 8"
786-1847	8" x 10"
786-1848	10" x 12"

Without Lid



786-1849
Instrument Box

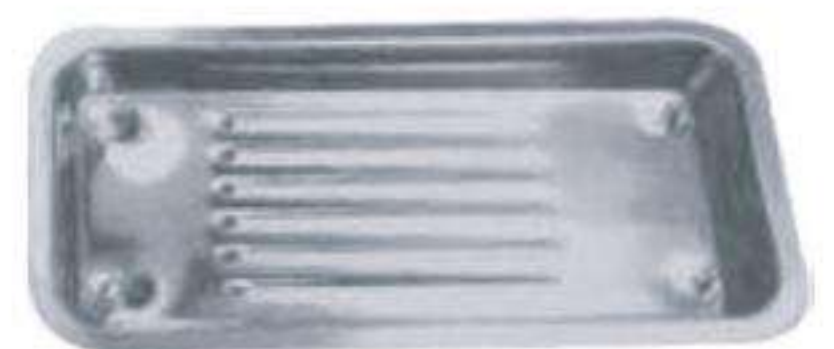

SCALER TRAY
786-1850
100 x 200 mm

INDEX

DESCRIPTION	PAGE #
3 PRONG CLASP ADJUSTABLE PLIER TC	107
ACORN FILLING INSTRUMENTS	52
ADAMS PIER WITH TC	102
ADAMS PLIER ROUND BOX	100
ADAMS PLIER FOR BENDING WIRE	100
ADAMS, SMALL WIRE BENDING AND LOOP FORMING PLIERS	99
ADERER FACEBOW LOOP FORMING PLIERS	101
ADERER LARGE WIRE BENDING AND LOOP FORMING PLIERS	100
ADERER PLIER	101
ADSON BROWN TWEEZERS	32
ADSON CARBIDE TIPPED TISSUE FORCEPS	133
ADSON NEEDLE HOLDER	86
ADSON TWEEZER	32
ADSON TC TWEEZERS	32
ALLEN PERIOSTEEL ELEVATORS	95
ALLIS 4:5 HAEMOSTATIC FORCEPS	87
ALLIS-BABY 3:4 HAEMOSTATIC FORCEPS	87
AMALGAM CARVERS	56,57,70-71
AMALGAM FILES	71
AMALGAM INSTRUMENTS & SCALPEL HANDLES	92
AMALGAM INSTRUMENTS	93
AMALGAM WELL MATRIX RETAINERS	91
AMALGAM WELL	93
ANATOMICAL CARVER	71
ANDREW RESTORATIVE INSTRUMENTS	70
ANGLE FORMERS	72
ANGLED DIRECT BOND BRACKET REMOVER TC	106
ANISWORTH CLAMPS FORCEPS	88
ANTERIOR FILLING INSTRUMENTS	68
ANTERIOR	47
APEXO ROOT ELEVATORS	15-19
APICAL ROOT ELEVATORS	19
ARCH FORMING PLIERS	104
ARTICULATORS	77
A-ATRAUMATIC EXTRACTION SET	03
ATRAUMATIC TWEEZER	31
BACK ACTION FILLING INSTRUMENTS	52
BACKHAUS HAEMOSTATIC FORCEPS	87
BACOLITE HANDLE WAS KNIVES	76
BALDWIN FILLING INSTRUMENTS	49
BALL FILLING INSTRUMENTS	52
BALL HOOK CRIMPING PLIER	105
BAND PUSHER	90
BAND REMOVING PLIER	99
BAND SEATER AUTO CLEAVABLE	97
BAND SEATING PLIER	104
BANDS & CROWN PLIER	101
BASINS FOR BONE	138
BAUMGARTNER NEEDLE HOLDERS	85
BAUMGARTNER NEEDLE HOLDERS	86
BAYONET ROOT ELEVATOR SET	21
BEAVERTAIL FILLING INSTRUMENTS	52
BEEBEE NEEDLE HOLDERS	85
BEIN ROOT ELEVATORS	15-16,24
BEYER BONE RONGEUR	14
BINANGLE FILLING INSTRUMENTS	74
BIRD BEAK ANGLED BENDING PLIER	103
BIRD BEAK PLIER WITH TC	102
BIRD BEAK WIRE BENDING & CUTTING PLIERS	101
BIRD BEAK WIRE BENDING PLIERS	100
BIRE BEAK WITH CUTTER PLIERS	104
BLACK FILLING INSTRUMENTS	50
BLACK TITANIUM COLOUR COATED INSTRUMENTS	110,111
BLADE AND PUSHER	126
BLUMENTAL BONE RONGEUR	14
BOGHOSIAN FILLING INSTRUMENTS	49
BOGHOSIAN IMPLANTOLOGY INSTRUMENTS	111
BOLEY GAUGE	109
BONE BRACKET GAUGE	96
BONE CARRIERS TITANIUM	124
BONE CRUSHER	138, 140
BONE EXPENDER SCREW & SURGICAL SET	141
BONE FILES	94
BONE GRAFT/CARRIER TITANIUM	128
BONE GRAFTING INSTRUMENTS COMPACTOR/TAMPERS	125
BONE GRAFTING INSTRUMENTS	126-127
BONE INJECTORS, COLLECTOR & SUCTION TUBE	142
BONE MILL	138
BONE RONGEUR	15A
BONE SCRAPER STRAIGHT & CURVED	138
BONE SPOON/PACKER	125
BONE THICKNESS GAUGE	109
BONE UNIVERSAL KIT	141
BRACKET REMOVER ANGULATED PLIER	103
BRACKET REMOVER PLIER STRAIGHT	103
BRACKET REMOVER PLIER ANGLED WITH TC	102
BRACKET REMOVER PLIER STRAIGHT WITH TC	102
BRACKET REMOVING PLIER ROUND BOX	99
BRACKET REMOVING PLIER	99
BREWER CLAMPS FORCEPS	88
BURNISHER FILLING INSTRUMENTS	49
BURNISHER FILLING INSTRUMENTS	54
BURNISHER UNIVERSITY MICHIGAN AMALGAM CARVERS	56
BURNISHER FILLING INSTRUMENTS	52-53
BURNISHER IMPLANTOLOGY INSTRUMENTS	112
BUSER PERIOSTEEL ELEVATORS	95
CARRY FORCEPS	134
CARVER HOLLENBACK AMALGAM CARVERS	56

DESCRIPTION	PAGE #
CARVERS FILLING INSTRUMENTS	69
CARVERS INSTRUMENTS	73
CARVERS	71
CASTROVIEJO NEEDLE HOLDERS	86
CASTROVIEJO SCISSORS	84
CEMENT SPATULAS	75
CHEEK RETRACTORS LONG	80
CHEEK RETRACTORS	78
CHEEK RETRACTORS MINNESOTA	80
CHEEK RETRACTORS, RETRACTOR IVORY	80
CHEEK RETRACTORS TONGUE DEPRESSORS	80
CHISEL HOES FILLING INSTRUMENTS	74
CLAMP OSTEOMETER	109
CLAMPPISON/FRAHAM RESTORATIVE INSTRUMENTS	70
CLAW-LIFT ROOTS ELEVATOR	22
COHEN UNIVERSAL FORCEPS	10-10
COLLEGE CURVED	32
COLLEGE TWEEZER	32
COLLEGE WITH LOCK TWEEZERS	31
COLLINS TONGUE FORCEPS	
COMPOSITE PLASTIC FILLING INSTRUMENTS	49-50,54
CONDENSER INSTRUMENTS	118
CONDENSER MORTONSON FILLING INSTRUMENTS	50
CONTOURING INSTRUMENT /IMPLANTOLOGY INSTRUMENTS	111
CONTOURING PLIER	101
COSMETIC CONTOURING	113
COTTON HOLDER	148
COUPLAND ROOT ELEVATOR	17
COUPLAND ROOT ELEVATOR	18
CRANE KAPLAN TWEEZER	32
CRANE KAPLAN PERIODONTAL INSTRUMENTS	59
CRILE NEEDLE HOLDERS	85
CRILE WOOD NEEDLE HOLDERS	85-86
CROWN AND BAND CONTOURING PLIERS	105
CROWN REMOVER	90
CROWN SPREADERS	90
CRUER EXTRACTING FORCEPS	10
CRUER ROOTS ELEVATORS	23
CURETTE COLUMBIA	43
CURETTE INSTRUMENTS	63
CURETTE McCALL	43
CURETTE	60
CURETTEE SET OF 8 PIECES	43
CURETTES	40-43,61-62
CUTTING INS PERIODONTAL INSTRUMENTS	39
DARBY-PARRY EXCAVATORS	65
DE LA ROSA PLIERS WITH GROOVED	105
DE LA ROSA PLIERS	105
DEAN SCISSORS	84
DEBAKEY ATRAUMATIC TISSUE FORCEPS	133
DEEP BOWL	148
DEEP ROOT PICK FORCEPS (APICAL SET OF 9)	04
DELICATE NEEDLE HOLDERS	85
DELUX BRACKET HOLDER TWEEZERS	96
DENHARD CHEEK RETRACTORS	79
DENTAL MIRRORS PERIODONTAL INSTRUMENTS	39
DENTAL SYRINGES	14C
DERF NEEDLE HOLDERS	85
DERF NEEDLE HOLDERS	86
DIRECT BOND BRACKET HOLDERS TWEEZER	96
DIRECT BONDING BRACKET HOLDERS	96
DIRECT BONDING BRACKET REMOVER PLIERS TC	106
DIRECT BRACKET REMOVERS TC	107
DISCOID-CLEOED CARVER	71
DISTAL END CUTTER REGULAR WITH TC	102
DISTAL END CUTTER SAFETY HOLD PLIER (IDEAL FOR CUTTING WIRE) JTC	107
DISTAL END WIRE CUTTER & BRACKET REMOVER PLIERS	107
DOUBLE ENDED CEMENT SPATULA	98
DRESSING TWEEZER	31-32
ELASTIC SEPARATING PLIER	107
ELASTOMERIC LIGATURE PLACEING FORCEPS WITH GROOVE FALCON	107
ELLIOT MATRIX RETAINERS	91
ENDED CHEEK RETRACTORS	79
ENDODONTIC BOX	148
ENDODONTICS INSTRUMENTS	47
ENGLISH PATTERN KLEIN #3 PERIODONTIC FORCEPS	08
EXAMINATION KIT SET OF 3 PIECES	34
EXAMINATION KIT SET OF 4 PIECES	34
EXCAVATORS	37
EXCAVATORS PERIODONTAL INSTRUMENTS	39
EXCAVATORS INSTRUMENTS SET OF 11 PIECES	57
EXCAVATORS INSTRUMENTS	64-67
EXCAVATORS	64
EXPLORERS PERIODONTAL INSTRUMENTS	39
EXPLORERS INSTRUMENTS	35
EXPLORERS	33-45
EXTRACTING FORCEPS (AMERICAN PATTERN)	10-14, 14A-14B
EXTRACTING FORCEPS (ENGLISH PATTERN)	01-02,05-07
EXTRA-FLEX IMPLANTOLOGY INSTRUMENTS	114
FALCON BEAK CONTOURING PLIERS	100
FARABEU RETRACTOR	82
FRIEDMAN RETRACTOR	82
FILES FILLING INSTRUMENTS	53
FILLING INS PERIODONTAL INSTRUMENTS	39
FILLING INSTRUMENTS	37,44,49-55,69,72
FLATE NOSE PLIER SMOOTH	105

DESCRIPTION	PAGE #
FLAT NOSE PLIER WITH SERRATION	105
FLOHR ROOT ELEVATORS	20
FLUCH-OUT DISTAL AND CUTTING PLIERS	100
FOERSTER DRESSING FORCEPS	
FORCEP JAR	148
FREEDMAN "DUCKHEAD" IMPLANTOLOGY INSTRUMENTS	112
FREEDMAN "BURNISHERS" IMPLANTOLOGY INSTRUMENTS	112
FREER PERIOSTEEL ELEVATORS	95
FRIEDMAN BONE RONGEUR	14
FRIEDMAN ROOTS ELEVATORS	21
GAUGE FOR MEASURING	109
GERALD TWEEZERS	31
GILLES TWEEZERS	31
GILLES NEEDLE HOLDER AND SCISSORS	
GOLDMAN FOX EXPLORERS	36
GOLDMAN FOX MERRIT B EXPLORERS	36
GOLDMAN FOX UNIVERSITY OF MICHIGAN EXPLORERS	36
GOLDMAN FOX WILLIAMS EXPLORERS	36
GOLDMAN FOX PERIODONTAL INSTRUMENTS	58
GOLDMAN FOX PERIOSTEEL ELEVATORS	95
GOLDMAN FOX SCISSORS	83-84
GOLDMAN FOX SET	61
GOLDSTIEN INTERPROXIMAL ELEVATOR	67
GRACEY AFTER FIVE	42
GRACEY CURETTE INSTRUMENTS	62
GRACEY CURETTE SET CASSETTES	147
GRACEY CURETTE	43
GRACEY MINI FIVE	42
GRACEY PERIODONTAL INSTRUMENTS	39
GRACEY CURETTE SET OF 7 Pcs	40-41
GRAFT PACKER, CANCAVE TIPS	125
GREGG IMPLANTOLOGY INSTRUMENTS	111
GRITMAN CEMENT SPATULAS	75
GROSS MAIER DRESSING FORCEPS	
GUM SCISSORS	
HAEMOSTATIC FORCEPS & TOWEL CLAMPS	87
HALSEY NEEDLE HOLDERS	85-86
HALSTEAD MOSQUITO HAEMOSTATIC FORCEPS	87
HANSTEAD MOSQUITO NEEDLE HOLDER	86
HALTPINZETTE WITH LOCK	134
HAMMER HEAD TIE BACK PLIER	104
HANDLESS MOUTH MIRRORS	30
HARD WIRE CUTTERS	107
HARRIS EXTRACTING FORCEPS	11
HARTMANN (BABY MOSQUITO NEEDLE HOLDER)	86
HATCHETS FILLING INSTRUMENTS	68
HEAT CARRIERS	46
HEBER ROOTS ELEVATOR	24
HEIDBRINK ROOTS ELEVATOR	20-21,26
HEIDMANN PERIODONTAL INSTRUMENTS	39
HEMINGWAY CURETTE INSTRUMENTS	63
HEMINGWAY TWEEZERS	32
HOES	71
HOLLANBACK PERIODONTAL INSTRUMENTS	39
HOLLENBACK FILLING INSTRUMENTS	50
HOLLENBACK IMPLANTOLOGY INSTRUMENTS	114
HOLLENBACK RESTORATIVE INSTRUMENTS	70
HOLLOW HANDLE	132
HOLLOWWARE	148
HOLLOWCHOP CONTOURING PLIER	106
HOOK CRIMPING PLIER ANGLED STRAIGHT TC	107
HOOK KNIVES	76
HOW PLIER CURVED WITH TC	103
HOW PLIER CURVED	99,104
HOW PLIER STRAIGHT WITH TC	103
HOW PLIER STRAIGHT	103
HOWARD PERIOSTEEL ELEVATOR	95
HYGIENIST PERIODONTAL INSTRUMENTS	58
HYGIENIST-JACQUETTE PERIODONTAL INSTRUMENTS	58
HYGIENIST TOWNER PERIODONTAL INSTRUMENTS	58
HYLIN CEMENT SPATULAS	75
HYLIN ROOTS ELEVATOR	23
IMPLANT GAGES	108
IMPLANT SINUS LIFT INSTRUMENTS	117, 122
IMPLANT	123
IMPLANTOLOGY INSTRUMENTS	112
IMPLANTOLOGY INSTRUMENTS	111
IMPLANTOLOGY	108-110
IMPRESSION TRAYS	143-146
INSTRUMENTS BOX	148
INSTRUMENT CASSETTES & STAND	147
INTERPROXIMAL CARVER IMPLANTOLOGY INSTRUMENTS	111
INTERPROXIMAL OFF-ANGLED FILLING INSTRUMENTS	49
INTRALIGAMENTAL ANESTHESIA SYRINGES	13
IRIS SCISSORS	83-84
IVORY LIGHT WEIGHT CLAMPS FORCEPS	88
IVORY MATRIX RETAINER	91
IWANSON SPRING CALIPER	109
JACQUETTE SCALER PERIODONTAL INSTRUMENTS	59
JARA BEAK PLIER	104
JENNINGS CHEEK RETRACTORS	79
JOHANSON CONTOURING PLIERS	100
JONES HAEMOSTATIC FORCEPS	87
JOSEPH SCISSORS	84
KELLY HAEMOSTATIC FORCEPS	87
KELLY SCISSORS	83-84
KELLY-RANKIN HAEMOSTATIC FORCEPS	87
KESFOR IMPLANT SCREW	139

INDEX

DESCRIPTION	PAGE #	DESCRIPTION	PAGE #	DESCRIPTION	PAGE #
KIDNEY TRAY WITH COVER (ENGLISH PATTERN)	148	ORTHO LIGHT SCALER HEAVY	97	SINUS LIFT INSTRUMENT	118-121
KIDNEY TRAYS	148	ORTHO LIGHT SCALER SINGLE ENDED	98	SINUS LIFT SET STAND	147
KILNER RAGINELL SCISSOR	84	ORTHO LIGHT SCALER	97	SINUS WINDOW BONE TMPERS	127
KLIENERT KUTZ BONE RONGEUR	14	ORTHODONTIC INSTRUMENTS	96-98	SINUS LIFT INSTRUMENT	118
KOPP ROOTS ELEVATOR	23-24	ORTHOLIGHT LIGATURE DIRECTOR SCALER	98	SIQVELAND RETAINERS TUFFLEMIRE-JUNIER MATRIX RETAINERS	91
KRARNER NEVINS BONE CHISEL	94	OSTEOMETER MEASURIGN FORCEPS	96	SMAHA ELASTOMERIC LIGATURE PLACING FORCEPS	107
LA GRANGE SCISSORS	83-84	OSTEOTOME CONVEXES / CONVAVE / CONIQUES	135-136	SPENCER SCISSORS	84
LADMORE FILLING INSTRUMENTS	52	OVAL SPOON DERBY-PARRY	65	SPIRIT LAMP	148
LADMORE IMPLANTOLOGY INSTRUMENTS	112	PK THOMAS WAXING INSTRUMENTS	73	SPOON AND PUSHER (TRINIVO)	128
LAP-JOINT THREE PRONG PLIER	106	PALATAL ARCH PLIER	105	SPOON AND PUSHER WITH SAFETY STOP	128
LAXUTOR ROOT ELEVATOR	19	PALMER CLAMPS FORCEPS	88	SPOONS	64
LE CRON CEMENT SPATULAS	75	PDL ELEVATORS	28-29	SPREADERS	46
LESSMANN	76	PEDIETRIC TOOTH EXTRACTING FORCEPS SET	09	STANDARD LIGATURE CUTTER TC	106
LIGATURE FORMING PLIER	101	PERIODONTAL FILLING INSTRUMENTS	53	STEP PLIERS WITH TC	103
LIGHT WIRE BIRD BEAK LONG PLIER WITH TC	102	PERIODONTAL INSTRUMENTS	37, 39, 58, 60, 95	STERILIZING DRUM	148
LIGHT WIRE BIRD BEAK LONG PLIER	104	PERIODONTAL PROBES	46-48	STOP V BENDING PLIER	105
LIGHT WIRE BIRD BEAK PLIER	104	PERIOSTEALS ELEVATORS	95, 129-130	STRAIGHT DIRECT BOND BRACKET REMOVER TC	107
LIGHT WIRE CUTTER MICRO WITH TC	102	PERIOTOME ROOTS ELEVATORS	26	SURGICAL CHISELS	123
LIGHT WIRE PLIER	104	PERRY TWEEZER	31-32	SURGICAL TWEEZERS	31
LINDO LEVIN ROOT ELEVATOR	20	POSTERIOR BEND REMOVER PLIER LONG	103	SUTURE PLIERS SUTURE FORCEPS	133
LINGUAL PLATAL ARCH FORMING PLIER	101	POSTERIOR BEND REMOVER PLIER MEDIUM	103	SYNDESMOTOMES ROOTS ELEVATOR	26
LINGUAL PLIER LONG HANDLE	106	POSTERIOR BEND REMOVER PLIER SHORT	103	TAMPER	126
LINGUAL PLIER WENGART	106	PIN & LIGATURE CUTTERS TC	106	TANNER FILLING INSTRUMENTS	52, 69
LINGUAL WENGART PLIER	106	PIN HOLDING PLIER TC	107	TANNER IMPLANTOLOGY INSTRUMENTS	114
LINING APPLICATOR DOUBLE END	55	PIN TWEEZER	134	TC GRIPPER CARBIDE	133
LOCKLIN SCISSOR	84	PLAIN MIRRORS	30	THORP RESTORATIVE INSTRUMENTS	70
LONDON COLLEGE TWEEZER	31	PLASTER KNIFE 76 SPECIAL INOX	76	THREE PRONG PLIERS REGULAR	106
LORNA HAEMOSTATIC FORCEPS	87	PLIERS FOR ORTHODONTICS & PROSTHETICS	99-106	TISSUE GRAFT FORCEPS SERRATED TEETH	133
LUCAS	132	PLUGGER PERIODONTAL INSTRUMENTS	39	TISSUE MEMBRANE FORCEPS	132, 134
LUER BONE RONGEUR	14	PLUGGER BLACK AMALGAM CARVERS	56	TISSUE PUNCH FORCEPS	134
LUKS	47	PLUGGERS	45, 48	TISSUE PUNCH STRAIGHT & CURVED	138
LAXATOR ROOT ELEVATORS	15-16, 21	PLUGGER CONDENSERS/ FILLING INSTRUMENTS	50	TUFFLEMIRE SENIOR MATRIX RETAINER	91
LUXIER ROOTS ELEVATORS	22	PLUGGER CONDENSERS	51	TUFFLEMIRE UNIVERSAL MATRIX RETAINER	91
MAGNIFYING MIRRORS	30	POINTED CURETTE	60	TORQUE WRENCH & RATCHET	139
MANUAL CROWN REMOVER	90	POINTED PROBES SINGLE ENDED	36	TOWNER PERIODONTAL INSTRUMENTS	58
MARCOTTE LOOPING PLIER	105	POSTERIOR	48	TOWNER JACQUETTE PERIODONTAL INSTRUMENTS	58
MARGIN TRIMMERS	72	POSTERIOR BAND REMOVER PLIERS	102	TREPHINE DRILL SET OF EIGHT PIECES	137
MARGINAL RIDGE & EMBRASURE SHPING INSTRUMENT	113	POTT ROOTS ELEVATORS	25	TUFTS FILLING INSTRUMENTS	49
MARKLEY PLUGGER / CONDENSERS	51	POWER CROWN REMOVER LIFT	90	TUNNELERUNGES INSTRUMENTS	126
MARQUETTE FILLING INSTRUMENTN	50	PRICHARD PERIOSTEEL ELEVATOR	95	TWEED ANGEL FORMING AND TORQUING PLIERS	101
MARYAM TWEEZER	32	PROBES DOUBLE ENDED	35	TWEED ANGLE RECTANGULAR ARCH FORMING & TORQUING PLIER	100
MATHEU NEEDLE HOLDERS	86	PROBES SINGLE ENDED	34	TWEED ARCH FORMING PLIER TC	102
MATRIX RETAINER	91	QUIETIN FILLING INSTRUMENT	49	TWEED CUTTER PLIER	104
MAYO NEEDLE HOLDER	85	RASPATOR BENQUE	131	TWEED LOOP FORMING PLIERS	100
MAYO SCISSOR	83	RASPATOR FREER	129, 131	TWEED LOOP FORMING PLIERS TC	105
MAYO HEGAR NEEDLE HOLDER	85-86	RASPATOR MICRO FREER	131	TWEED LOOP FORMING PLIERS	99
MEAD 1A BONE RONGEUR	14	RASPATOR MICRO CHISEL	131	TWEED LOOP PLIERS	104, 105
MEAD BONE FILES	94	RASPATOR MICRO FREER	129	TWEEZERS PERIODONTAL INSTRUMENTS	39
MEASURING LOOP	109	RASPATOR NORDBERG	131	TWEEZERS	31
MEASURING LOOP CASTROVIEJO	109	RASPATOR PRICHARD	124	TWEEZERS	32
MEDIUM CEMENT SPATULAS	75	RASPATOR PERIOSTEEL ELEVATORS	95	TWIEL ON ELASTIC MODULE INSTRUMENT	97
MEDIUM PLACING CONDENSER/ IMPLANTOLOGY INST	114	RASPATOR WAUTIER	131	UNIVERSAL DOLPHIN STYLE WIRE BENDING & CUTTING PLIERS	99
MEMBRANE POSITIONING INSTRUMENTS	118	RASPATOR WILLIGER PERIOSTEEL ELEVATORS	95	UNIVERSAL FILLING INSTRUMENTS	49
MEMBRANE TWEEZER KUEHNE	134	RASPATORY CHPPING	131	UNIVERSAL FILLING INSTRUMENTS	54
MERIAM TWEEZER	31	RASPATORY MICRO MOLT	131	UNIVERSAL NEEDLE HOLDERS	85
MERRIT A EXPLORER	36	RASPATORY MOLT	131	UNIVERSITY OF MICHIGAN EXPLORERS	36
MERRIT B EXPLORER	36	REGULAR TWEED ARCH FORMING PLIERS	104	UTILITY PLIER WIENGART TC	107
MERSHON CROWN REMOVER	90	RESTORATIVE INSTRUMENTS	51, 53, 68, 70, 72	V BEND STOP PLIER TC	106
METZENBAUM NEEDLE HOLERS	85	RETRACTOR WITH ERGO GRIP	90	W BARRY ROOTS ELEVATOR	25
METZENBAUM SCISSORS	83	RETRACTOR MOUTH GAGS	78, 79	WAHL BONE FILES	94
MICRO ADSON TISSUE FORCEPS	133	RETRACTORS	80, 82	WALDSAVHS WIRE BENDING AND CUTTING PLIERS	101
MICRO IRIS SCISSORS	83	RETRACTORS CHEEK RETRACTOR COMBINATION	80	WALL FILLING INSTRUMENTS	69
MICRO FREDMAN BONE RONGEUR	14	RETRACTORS COMBINATION	81	WANGEN HOLDER	78
MILLER BONE FILES	94	RETRACTORS LANGENBECK	82	WARD AMALGAM CARRIER	56
MILLER TWEEZER	32	RETRACTORS MINI LANGENBECK	81	WARD FILLING INSTRUMENTS	69
MILLER	132	RETRACTORS UNIQUE	81	WAX KNIVES	76
MINI LIGATURE CUTTER	100	RETRO FILLING	48	WEDELSTEADT	71
MINI PIN & LIGATURE CUTTER TC	106	REVERSED LIGATURE CUTTER ANGLED	102	WEINGART GENERAL UTILITY PLIER LONG MOUTH WITH TC	103
MIXING SPATULAS WITH SHOVEL	124	RHODIUM MIRRORS	30	WEINGART PLIER MEDIUM	99, 101
MODIED McCALL	60	ROCHESTER KOCHER 1X2 HAEMOSTATIC FORCEPS	87	WEINGART PLIER REGULAR WITH TC	103
MOLT BONE FILES	94	ROCHESTER PEAN HAEMOSTATIC FORCEPS	87	WEINGART PLIER SLIM WITH TC	102
MOLT PERIOSTEEL ELEVATOR	95	ROOT ELEVATORS	15-29	WEINGART PLIER UNIVERSAL WITH TC	103
MORTONSEN FILLING INSTRUMENT	55	ROOT PLANING FILES	94	WEINGART PLIER UTILITY WITH TC	103
MOUTH GAG MOLT	78	ROOT PLANNING FILES & BONE FILES	94	WEITLANDER CHEEK RETRACTORS	79
MOUTH MIRROR	37	ROOTS ELEVATOR	22	WEITLANDER CHEEK RETRACTORS	79
MSY CEMENT SPATULAS	75	ROSER-KONIG CHEEK RETRACTORS	79	WERDELSTEADT FILLING INSTRUMENTS	74
MULTIFUNCTION METER	108	ROUND NOSE PLIER	104	WESTON CEMENT SPATULAS	75
NAKWALIN DENTAL LABORATORY INSTRUMENT	77	ROUNDED CONE	73	WIDE MATRIX RETAINER	91
NANCE LOOP FORMING PLIERS	99	ROUNDED CONE FILLING INSTRUMENTS	49	WILLIAM PROBE SET	38
NANCE PLIER	105	RUBBER DAM CLAMPS	89	WILLIAM EXPLORER	36
NARROW MATRIX RETAINERS	91	RUBBER DAM CALMPS FORCEPS	134	WINGURT PLIER SLIM	105
NEEDLE HOLDERS	85-86	RUSSIAN LONG TISSUE FORCEPS	134	WINGURT UTILITY PLIER	105
NEUMMAN SCISSORS	84	RUSSIAN TISSUE FORCEPS	148	WINTER ROOTS ELEVATORS	25
NOYES SCISSORS	84	SCALERS TRAY	60	WIRE BENDING & LOOP FORMING PLIERS	99
OCCLUSAL ANATOMY INSTRUMENT	113	SCALER CURETTE SETS	61	WISDOM ROOTS ELEVATORS	21
OHL PERIOSTEEL ELEVATORS	95	SCALER CURETTE SETS INSTRUMENTS	97	WOODEN HANDLE	76
OLSEN HEAGAR NEEDLE HOLDER WITH SCISSORS		SCHURE BAND SEATER	88	WOODSON FILLING INSTRUMENTS	49
OREGON PLUGGERS CONDENSERS	51	SEPARATING ELASTIC PLIER	95	YOUNG PLIER WITH GROOVED	105
ORTHO BAND PUSHER SCALER	98	SELDIN PERIOSTEEL ELEVATORS	82	YOUNG TONGUE FORCEPS	
ORTHO INSTRUMENT	97	SELDIN RETRACTOR	45, 48, 25	YOUNG SIRE BENDING & LOOP FORMING PLIERS	99
ORTHO LIGATURE DIRECTOR SINGLE ENDED	98	SELDIN ROOT ELEVATORS	133	ZAHLE CEMENT SPATULAS	75
ORTHO LIGHT BAND PUSHER SCALER	97-98	SELF LOCKING GROOVED	32		
ORTHO LIGHT DOUBLE ENDED LIGATURE DIRECTOR SCALER	98	SELF LOCKING TWEEZER	31		
ORTHO LIGHT DOUBLE ENDED LIGATUR DIRECTOR	98	SEMKEN TAYLOR TWEEZERS	39		
ORTHO LIGHT DOUBLE ENDED LIGATUR SCALER	98	SICKLE PERIODONTAL INSTRUMENTS	39		
ORTHO LIGHT DOUBLE ENDED LIGATURE SCALER/DIRECTOR	98	SICKLE SCALERS INSTRUMENTS	58		
ORTHO LIGHT LIGATURE DIRECTOR DOUBLE ENDED	98	SINGLE ENDED PROBE	33		
ORTHO LIGHT SCALER DOUBLE ENDED	97	SINUS LIFT ELEVATOR	115-116		



CONTACT US

**ADDRESS: SHOP NO 5 UMER CENTER OPPOSITE BOOTA
PETROL PUMP SHAHABPURA ROAD SIALKOT**

CALL / WHATSAPP: +92 336 4455318

EMAIL: INFO@EPICDENTSOLUTION.COM

WEB: WWW.EPICDENTSOLUTION.COM

FACEBOOK: [HTTPS://WWW.FACEBOOK.COM/PROFILE.PHP?ID=100069834078019](https://www.facebook.com/profile.php?id=100069834078019)

INSTAGRAM: EPIC_DENT_SOLUTION